

The Garador Range Spares Catalogue

Up & Over Doors, Sectional Doors, Side-hinged Doors and Operators



April 2008

GARADOR
The Garage Door People

Contents

C-Type Overhead Spring Box fitted to a timber frame	4
C Type Side Extension Spring fitted to a Timber Frame	8
F-Type & MK 4 Spring	10
R, FR & DR Spring	12
DC Type Spring	14
Cables, Rollers, Spindles	16
Keys, Locking Barrels.	17
Handle Mechanisms	18
Latches	20
C & F Type Accessories	21
DR, R, FR & DC Type Accessories	22
Springs	23
Spares for current range of Electric Operators	24
Radio Receivers, Transmitters, Autodor Spares.	25
Consumables	26
Care	29
Warranty	30
Extracts from AGDS consumer advice	31



Please ensure that you order the correct size door to fit your opening as we are unable to accept the return of incorrectly ordered goods. Please contact Garador on 01935 443722 if you need assistance in calculating the correct size.

A comprehensive range of the more popular spares is available. Please ask for spares price list.

All prices in £.





Note: All orders for spares carry a postage and package cost of £6.50 per order regardless of the quantity or value.



Since the company's policy is one of continuous improvement of its products, we reserve the right to make any alterations in design, manufacture or price. All business is governed by the Company's Standard Conditions and this document does not form any part of any contract with the company and statements contained in it should not be construed as representations or warranties.

C-Type Overhead Spring Box fitted to a timber frame

Steel Panel Doors

Used on all Canopy doors pre 1999. Springs priced and supplied individually. However, it is always recommended that both springs are replaced at the same time.

 £ 52.60 ea.	 GEORGIAN/GEORGIAN ELITE			 CARLTON/CARLTON ELITE			 SALISBURY/SALISBURY ELITE		
	Spring box number	Spring box spring	No. of bands & colour	Spring box number	Spring box spring	No. of bands & colour	Spring box number	Spring box spring	No. of bands & colour
6'6"x6'3"	-	-	-	PN58	S1703001-3-1	1 x Silver	-	-	-
6'6"x6'6"	PN167	S1703001-3-6	None	PN58	S1703001-3-1	1 x Silver	-	-	-
6'6"x7'0"	PN167	S1703001-3-6	None	PN58	S1703001-3-1	1 x Silver	-	-	-
7'0"x6'3"	-	-	-	N/A	N/A	N/A	-	-	-
7'0"x6'6"	PN57/1	S1703001-3-2	1 x Blue	PN58	S1703001-3-1	1 x Silver	PN55/2	S1703001-3-4	3 x Blue
7'0"x7'0"	PN150	S1703001-3-10	None	PN55/2	S1703001-3-4	3 x Blue	PN155	S1703001-3-11	1 x Orange
7'3½"x6'4"	-	-	-	PN57/1	S1703001-3-2	1 x Blue	-	-	-
7'5"x6'3"	-	-	-	-	-	-	-	-	-
7'5"x6'6"	PN55/2	S1703001-3-4	3 x Blue	PN57/1	S1703001-3-2	1 x Blue	PN155	S1703001-3-11	1 x Orange
7'5"x7'0"	PN108	S1703001-3-9	2 x Orange	PN150	S1703001-3-10	None	PN108	S1703001-3-9	2 x Orange
7'6"x6'6"	PN55/2	S1703001-3-4	3 x Blue	PN57/1	S1703001-3-2	1 x Blue	PN155	S1703001-3-11	1 x Orange
7'6"x7'0"	N/A	N/A	N/A	N/A	N/A	N/A	N/A	N/A	N/A
7'8½"x6'3"	-	-	-	N/A	N/A	N/A	-	-	-
7'8½"x6'6¾"	PN150	S1703001-3-10	None	PN55/2	S1703001-3-4	3 x Blue	-	-	-
7'8½"x6'11¾"	N/A	N/A	N/A	PN155	S1703001-3-11	1 x Orange	-	-	-
8'0"x6'3"	-	-	-	N/A	N/A	N/A	-	-	-
8'0"x6'6"	PN150	S1703001-3-10	None	PN55/2	S1703001-3-4	3 x Blue	PN150	S1703001-3-10	None
8'0"x7'0"	PN108	S1703001-3-9	2 x Orange	PN155	S1703001-3-11	1 x Orange	PN155	S1703001-3-11	1 x Orange
8'2½"x6'3"	-	-	-	N/A	N/A	N/A	-	-	-
8'2½"x6'6¾"	-	-	-	PN150	S1703001-3-10	None	-	-	-
8'2½"x6'11¾"	-	-	-	PN155	S1703001-3-11	1 x Orange	-	-	-

	 HORIZON/HORIZON ELITE			 CHEVRON/CHEVRON ELITE			 BEAUMONT/BEAUMONT ELITE		
	Spring box number	Spring box spring	No. of bands & colour	Spring box number	Spring box spring	No. of bands & colour	Spring box number	Spring box spring	No. of bands & colour
6'6"x6'3"	PN58	S1703001-3-1	1 x Silver	-	-	-	-	-	-
6'6"x6'6"	PN58	S1703001-3-1	1 x Silver	PN167	S1703001-3-6	None	-	-	-
6'6"x7'0"	PN58	S1703001-3-1	1 x Silver	PN167	S1703001-3-6	None	-	-	-
7'0"x6'3"	N/A	N/A	N/A	-	-	-	-	-	-
7'0"x6'6"	PN58	S1703001-3-1	1 x Silver	PN57/1	S1703001-3-2	1 x Blue	S1703001-3-4	3 x Blue	
7'0"x7'0"	PN57/1	S1703001-3-2	1 x Blue	PN55/2	S1703001-3-4	3 x Blue	S1703001-3-11	1 x Orange	
7'3½"x6'4"	PN56/1	S1703001-3-3	2 x Blue	-	-	-	-	-	-
7'5"x6'3"	N/A	N/A	N/A	-	-	-	-	-	-
7'5"x6'6"	PN56/1	S1703001-3-3	2 x Blue	PN55/2	S1703001-3-4	3 x Blue	S1703001-3-4	3 x Blue	
7'5"x7'0"	PN55/2	S1703001-3-4	3 x Blue	PN155	S1703001-3-11	1 x Orange	-	-	-
7'6"x6'6"	PN57/1	S1703001-3-2	1 x Blue	PN55/2	S1703001-3-4	3 x Blue	-	-	-
7'6"x7'0"	N/A	N/A	N/A	N/A	N/A	N/A	S1703001-3-11	1 x Orange	
7'8½"x6'3"	N/A	N/A	N/A	-	-	-	-	-	-
7'8½"x6'6¾"	PN115	S1703001-3-8	2 x Silver	PN55/2	S1703001-3-4	3 x Blue	-	-	-
7'8½"x6'11¾"	PN55/2	S1703001-3-4	3 x Blue	PN155	S1703001-3-11	1 x Orange	-	-	-
8'0"x6'3"	N/A	N/A	N/A	-	-	-	-	-	-
8'0"x6'6"	PN115	S1703001-3-8	2 x Silver	-	-	-	-	-	-
8'0"x7'0"	PN150	S1703001-3-10	None	-	-	-	-	-	-
8'2½"x6'3"	N/A	N/A	N/A	-	-	-	-	-	-
8'2½"x6'6¾"	PN55/2	S1703001-3-4	3 x Blue	-	-	-	-	-	-
8'2½"x6'11¾"	PN155	S1703001-3-11	1 x Orange	-	-	-	-	-	-

C-Type Overhead Spring Box fitted to a timber frame

Steel Panel Doors



£ 52.60 ea.



CATHEDRAL/CATHEDRAL ELITE







PARADE-WHITE/BROWN



	Spring box number	Spring box spring	No. of bands & colour	Spring box number	Spring box spring	No. of bands & colour
6'6"x6'3"	-	-	-	-	-	-
6'6"x6'6"	-	-	-	PN167	S1703001-3-6	None
6'6"x7'0"	-	-	-	-	-	-
7'0"x6'3"	-	-	-	-	-	-
7'0"x6'6"	PN55/2	S1703001-3-4	3 x Blue	PN57/1	S1703001-3-2	1 x Blue
7'0"x7'0"	PN155	S1703001-3-11	1 x Orange	PN155	S1703001-3-11	1 x Orange
7'3½"x6'4"	-	-	-	-	-	-
7'5"x6'3"	-	-	-	-	-	-
7'5"x6'6"	PN55/2	S1703001-3-4	3 x Blue	PN155	S1703001-3-11	1 x Orange
7'5"x7'0"	-	-	-	PN155	S1703001-3-11	1 x Orange
7'6"x6'6"	-	-	-	N/A	N/A	N/A
7'6"x7'0"	PN155	S1703001-3-11	1 x Orange	N/A	N/A	N/A
7'8½"x6'3"	-	-	-	-	-	-
7'8½"x6'6¾"	-	-	-	-	-	-
7'8½"x6'11¼"	-	-	-	-	-	-
8'0"x6'3"	-	-	-	-	-	-
8'0"x6'6"	-	-	-	PN155	S1703001-3-11	1 x Orange
8'0"x7'0"	-	-	-	PN108	S1703001-3-9	2 x Orange
8'2½"x6'3"	-	-	-	-	-	-
8'2½"x6'6¾"	-	-	-	-	-	-
8'2½"x6'11¼"	-	-	-	-	-	-



C-Type Overhead Spring Box fitted to a timber frame

GRP Premier Panel Doors

Used on all Canopy doors pre 1999. Springs priced and supplied individually. However, it is always recommended that both springs are replaced at the same time.

 <p>£ 52.60 ea.</p>	 <p>STAMFORD</p>			 <p>ARDEN</p>			 <p>KENMORE</p>			
	Spring box number	Spring box spring	No. of bands & colour	Spring box number	Spring box spring	No. of bands & colour	Spring box number	Spring box spring	No. of bands & colour	
	7'0"x6'6"	N/A	N/A	N/A	PN55/2	S1703001-3-4	3 x Blue	PN55/2	S1703001-3-4	3 x Blue
	7'0"x7'0"	N/A	N/A	N/A	PN55/2	S1703001-3-4	3 x Blue	PN55/2	S1703001-3-4	3 x Blue
	7'5"x6'6"	N/A	N/A	N/A	PN155	S1703001-3-11	1 x Orange	PN155	S1703001-3-11	1 x Orange
7'6"x7'0"	N/A	N/A	N/A	PN155	S1703001-3-11	1 x Orange	PN155	S1703001-3-11	1 x Orange	

 <p>DERWENT</p>			 <p>SWINTON</p>			 <p>CLIFTON</p>		
Spring box number	Spring box spring	No. of bands & colour	Spring box number	Spring box spring	No. of bands & colour	Spring box number	Spring box spring	No. of bands & colour
7'0"x6'6"	N/A	N/A	PN55/2	S1703001-3-4	3 x Blue	PN55/2	S1703001-3-4	3 x Blue
7'0"x7'0"	N/A	N/A	PN55/2	S1703001-3-4	3 x Blue	PN55/2	S1703001-3-4	3 x Blue
7'5"x6'6"	N/A	N/A	PN155	S1703001-3-11	1 x Orange	PN155	S1703001-3-11	1 x Orange
7'6"x7'0"	N/A	N/A	PN155	S1703001-3-11	1 x Orange	PN155	S1703001-3-11	1 x Orange





 <p>OAKHAM</p>			 <p>WOBURN</p>			 <p>WENTWOOD</p>			
Spring box number	Spring box spring	No. of bands & colour	Spring box number	Spring box spring	No. of bands & colour	Spring box number	Spring box spring	No. of bands & colour	
7'0"x6'6"	PN55/2	S1703001-3-4	3 x Blue	N/A	N/A	N/A	PN55/2	S1703001-3-4	3 x Blue
7'0"x7'0"	PN55/2	S1703001-3-4	3 x Blue	N/A	N/A	N/A	PN155	S1703001-3-11	1 x Orange
7'5"x6'6"	PN155	S1703001-3-11	1 x Orange	N/A	N/A	N/A	PN55/2	S1703001-3-4	3 x Blue
7'6"x7'0"	PN155	S1703001-3-11	1 x Orange	N/A	N/A	N/A	PN155	S1703001-3-11	1 x Orange



 <p>SHERWOOD</p>			
Spring box number	Spring box spring	No. of bands & colour	
7'0"x6'6"	PN55/2	S1703001-3-4	3 x Blue
7'0"x7'0"	PN155	S1703001-3-11	1 x Orange
7'5"x6'6"	PN55/2	S1703001-3-4	3 x Blue
7'6"x7'0"	PN155	S1703001-311	1 x Orange



C-Type Overhead Spring Box fitted to a timber frame

Timber Panel Doors

Used on all Canopy doors pre 1999. Springs priced and supplied individually. However, it is always recommended that both springs are replaced at the same time.

 <p>£ 52.60 ea.</p>	 <p>CHEVRON CEDAR</p>			 <p>VERTICAL CEDAR</p>			 <p>SANDHURST</p>			
	Spring box number	Spring box spring	No. of bands & colour	Spring box number	Spring box spring	No. of bands & colour	Spring box number	Spring box spring	No. of bands & colour	
	7'0"x6'6"	PN57/1	S1703001-3-2	1 x Blue	PN57/1	S1703001-3-2	1 x Blue	-	-	-
	7'0"x7'0"	PN55/2	S1703001-3-4	3 x Blue	PN55/2	S1703001-3-4	3 x Blue	PN55/2	S1703001-3-4	3 x Blue
	7'5"x6'6"	PN55/2	S1703001-3-4	3 x Blue	PN57/1	S1703001-3-2	1 x Blue	PN55/2	S1703001-3-4	3 x Blue
	7'5"x7'0"	PN55/2	S1703001-3-4	3 x Blue	PN150	S1703001-3-10	None	PN55/2	S1703001-3-4	3 x Blue
	7'6"x6'6"	PN55/2	S1703001-3-4	3 x Blue	PN55/2	S1703001-3-4	3 x Blue	PN55/2	S1703001-3-4	3 x Blue
7'6"x7'0"	-	-	-	PN55/2	S1703001-3-4	3 x Blue	-	-	-	





			 <p>CAVENDISH</p>			 <p>WOLSEY</p>			 <p>SEYMOUR</p>		
Spring box number	Spring box spring	No. of bands & colour	Spring box number	Spring box spring	No. of bands & colour	Spring box number	Spring box spring	No. of bands & colour			
7'0"x6'6"	-	-	PN55/2	S1703001-3-4	3 x Blue	PN55/2	S1703001-3-4	3 x Blue			
7'0"x7'0"	PN55/2	S1703001-3-4	PN155	S1703001-3-11	1 x Orange	PN155	S1703001-3-11	1 x Orange			
7'5"x6'6"	PN55/2	S1703001-3-4	PN55/2	S1703001-3-4	3 x Blue	PN55/2	S1703001-3-4	3 x Blue			
7'5"x7'0"	PN55/2	S1703001-3-4	PN155	S1703001-3-11	1 x Orange	PN155	S1703001-3-11	1 x Orange			
7'6"x6'6"	PN55/2	S1703001-3-4	PN55/2	S1703001-3-4	3 x Blue	PN55/2	S1703001-3-4	3 x Blue			
7'6"x7'0"	-	-	PN55/2	S1703001-3-4	3 x Blue	PN55/2	S1703001-3-4	3 x Blue			





			 <p>TUDOR</p>			 <p>HORIZONTAL CEDAR</p>		
Spring box number	Spring box spring	No. of bands & colour	Spring box number	Spring box spring	No. of bands & colour			
7'0"x6'6"	PN55/2	S1703001-3-4	PN57/1	S1703001-3-2	1 x Blue			
7'0"x7'0"	PN155	S1703001-3-11	PN55/2	S1703001-3-4	3 x Blue			
7'5"x6'6"	PN55/2	S1703001-3-4	PN57/1	S1703001-3-2	1 x Blue			
7'5"x7'0"	PN155	S1703001-3-11	PN150	S1703001-3-10	None			
7'6"x6'6"	PN55/2	S1703001-3-4	-	-	-			
7'6"x7'0"	PN55/2	S1703001-3-4	-	-	-			

C Type Side Extension Spring fitted to a Timber Frame

Steel Panel Doors

Used on all Canopy doors between 1999 and 2002. Springs priced and supplied individually. However, it is always recommended that both springs are replaced at the same time.





 £ 52.60 ea.	 GEORGIAN/ GEORGIAN ELITE		 BEAUMONT/ BEAUMONT ELITE		 CATHEDRAL/ CATHEDRAL ELITE		 CARLTON/ CARLTON ELITE	
	Spring type	No. of bands & colour	Spring type	No. of bands & colour	Spring type	No. of bands & colour	Spring type	No. of bands & colour
6'6"x6'3"	-	-	-	-	-	-	G230-18-1	White
6'6"x6'6"	G230-18-3	Green	-	-	-	-	G230-18-1	White
6'6"x7'0"	G230-18-5	Red	-	-	-	-	G230-18-2	2 x White
7'0"x6'3"	-	-	-	-	-	-	G230-18-1	White
7'0"x6'6"	G230-18-3	Green	G230-18-3	Green	G230-18-3	Green	G230-18-1	White
7'0"x7'0"	G230-18-5	Red	G230-18-4	2 x Green	G230-18-4	2 x Green	G230-18-2	2 x White
7'3½"x6'4"	-	-	-	-	-	-	G230-18-2	2 x White
7'5"x6'3"	-	-	-	-	-	-	G230-18-2	2 x White
7'5"x6'6"	G230-18-4	2 x Green	G230-18-3	Green	G230-18-3	Green	G230-18-2	2 x White
7'5"x7'0"	G230-18-5	Red	G230-18-5	Red	G230-18-5	Red	G230-18-3	Green
7'6"x6'6"	G230-18-4	2 x Green	G230-18-4	2 x Green	G230-18-4	2 x Green	G230-18-3	Green
7'6"x7'0"	G230-18-5	Red	G230-18-5	Red	G230-18-5	Red	G230-18-4	2 x Green
7'8½"x6'3"	-	-	-	-	-	-	G230-18-1	White
7'8½"x6'6¾"	G230-18-4	2 x Green	G230-18-4	2 x Green	G230-18-4	2 x Green	G230-18-2	2 x White
7'8½"x6'11¼"	G230-18-5	Red	G230-18-4	2 x Green	G230-18-4	2 x Green	G230-18-3	Green
8'0"x6'3"	-	-	-	-	-	-	G230-18-3	Green
8'0"x6'6"	G230-18-6	2 x Red	G230-18-4	2 x Green	G230-18-4	2 x Green	G230-18-4	2 x Green
8'0"x7'0"	G230-18-6	2 x Red	G230-18-5	Red	G230-18-5	Red	G230-18-4	2 x Green
8'2½"x6'3"	-	-	-	-	-	-	G230-18-3	Green
8'2½"x6'6¾"	-	-	-	-	-	-	G230-18-4	2 x Green
8'2½"x6'11¼"	-	-	-	-	-	-	G230-18-4	2 x Green





	 SALISBURY/ SALISBURY ELITE		 HORIZON/ HORIZON ELITE		 CHEVRON/ CHEVRON ELITE		 PARADE-WHITE/BROWN	
	Spring type	No. of bands & colour	Spring type	No. of bands & colour	Spring type	No. of bands & colour	Spring type	No. of bands & colour
6'6"x6'3"	-	-	G230-18-1	White	-	-	-	-
6'6"x6'6"	-	-	G230-18-1	White	G230-18-1	White	-	-
6'6"x7'0"	-	-	G230-18-2	2 x White	G230-18-2	2 x White	-	-
7'0"x6'3"	-	-	G230-18-1	White	-	-	-	-
7'0"x6'6"	G230-18-3	Green	G230-18-1	White	G230-18-2	2 x White	G230-18-3	Green
7'0"x7'0"	G230-18-5	Red	G230-18-2	2 x White	G230-18-2	2 x White	G230-18-4	2 x Green
7'3½"x6'4"	-	-	G230-18-1	White	-	-	-	-
7'5"x6'3"	-	-	G230-18-1	White	-	-	-	-
7'5"x6'6"	G230-18-5	Red	G230-18-1	White	G230-18-3	Green	G230-18-3	Green
7'5"x7'0"	G230-18-5	Red	G230-18-2	2 x White	G230-18-6	2 x Red	G230-18-5	Red
7'6"x6'6"	G230-18-5	Red	G230-18-3	Green	G230-18-4	2 x Green	G230-18-4	2 x Green
7'6"x7'0"	G230-18-5	Red	G230-18-3	Green	G230-18-6	2 x Red	G230-18-5	Red
7'8½"x6'3"	-	-	G230-18-1	White	-	-	-	-
7'8½"x6'6¾"	-	-	G230-18-2	2 x White	G230-18-4	2 x Green	G230-18-4	2 x Green
7'8½"x6'11¼"	-	-	G230-18-3	Green	G230-18-6	2 x Red	G230-18-4	2 x Green
8'0"x6'3"	-	-	G230-18-3	Green	-	-	-	-
8'0"x6'6"	G230-18-5	Red	G230-18-3	Green	-	-	G230-18-4	2 x Green
8'0"x7'0"	G230-18-6	2 x Red	G230-18-3	Green	-	-	G230-18-5	Red
8'2½"x6'3"	-	-	G230-18-3	Green	-	-	-	-
8'2½"x6'6¾"	-	-	G230-18-3	Green	-	-	-	-
8'2½"x6'11¼"	-	-	G230-18-4	2 x Green	-	-	-	-

C Type Side Extension Spring fitted to a Timber Frame

GRP Premier Panel Doors

Used on all Canopy doors between 1999 and 2002. Springs priced and supplied individually. However, it is always recommended that both springs are replaced at the same time.





 £ 52.60 ea.	 STAMFORD		 ARDEN		 KENMORE		 DERWENT	
	Spring type	No. of bands & colour	Spring type	No. of bands & colour	Spring type	No. of bands & colour	Spring type	No. of bands & colour
7'0"x6'6"	G230-18-2	2 x White	G230-18-2	2 x White	G230-18-2	2 x White	G230-18-2	2 x White
7'0"x7'0"	G230-18-3	Green	G230-18-3	Green	G230-18-3	Green	G230-18-3	Green
7'5"x6'6"	G230-18-2	2 x White	G230-18-2	2 x White	G230-18-2	2 x White	G230-18-2	2 x White
7'6"x7'0"	G230-18-3	Green	G230-18-3	Green	G230-18-3	Green	G230-18-3	Green





 SWINTON	 CLIFTON		 OAKHAM		 WOBURN			
	Spring type	No. of bands & colour	Spring type	No. of bands & colour	Spring type	No. of bands & colour	Spring type	No. of bands & colour
7'0"x6'6"	G230-18-2	2 x White	G230-18-2	2 x White	G230-18-2	2 x White	G230-18-2	2 x White
7'0"x7'0"	G230-18-3	Green	G230-18-3	Green	G230-18-3	Green	G230-18-3	Green
7'5"x6'6"	G230-18-2	2 x White	G230-18-2	2 x White	G230-18-2	2 x White	G230-18-2	2 x White
7'6"x7'0"	G230-18-3	Green	G230-18-3	Green	G230-18-3	Green	G230-18-3	Green

C Type Side Extension Spring fitted to a Timber Frame

Timber Panel Doors

Used on all Canopy doors between 1999 and 2002. Springs priced and supplied individually. However, it is always recommended that both springs are replaced at the same time. Due to timber design changes always check the colour bands on the springs before ordering.









 £ 52.60 ea.	 CHEVRON CEDAR		 VERTICAL CEDAR		 SANDHURST		 CAVENDISH	
	Spring type	No. of bands & colour	Spring type	No. of bands & colour	Spring type	No. of bands & colour	Spring type	No. of bands & colour
7'0"x6'6"	G230-18-2	2 x White	G230-18-1	White	-	-	-	-
7'0"x7'0"	G230-18-3	Green	G230-18-2	2 x White	G230-18-4	2 x Green	G230-18-4	2 x Green
7'5"x6'6"	G230-18-3	Green	G230-18-1	White	G230-18-3	Green	G230-18-3	Green
7'5"x7'0"	G230-18-3	Green	G230-18-2	2 x White	G230-18-4	2 x Green	G230-18-4	2 x Green
7'6"x6'6"	G230-18-3	Green	G230-18-2	2 x White	G230-18-3	Green	G230-18-3	Green
7'6"x7'0"	-	-	G230-18-2	2 x White	-	-	-	-

 WOLSEY	 SEYMOUR		 TUDOR		 HORIZONTAL CEDAR			
	Spring type	No. of bands & colour	Spring type	No. of bands & colour	Spring type	No. of bands & colour	Spring type	No. of bands & colour
7'0"x6'6"	G230-18-2	Green	G230-18-2	Green	G230-18-2	Green	N/A	N/A
7'0"x7'0"	G230-18-3	Green	G230-18-3	Green	G230-18-3	Green	N/A	N/A
7'5"x6'6"	G230-18-3	Green	G230-18-3	Green	G230-18-3	Green	N/A	N/A
7'5"x7'0"	G230-18-4	2 x Green	G230-18-4	2 x Green	G230-18-4	2 x Green	N/A	N/A
7'6"x6'6"	G230-18-3	Green	G230-18-3	Green	G230-18-3	Green	-	-
7'6"x7'0"	G230-18-4	2 x Green	G230-18-4	2 x Green	G230-18-4	2 x Green	-	-

F-Type & MK 4 Spring

Steel Panel Doors









Used on all Framed Canopy doors pre 2002. For springs with flat fixing pins part 54-6 is also required. Springs priced and supplied individually. However, it is always recommended that both springs are replaced at the same time.

 £ 55.50 ea.	 GEORGIAN/ GEORGIAN ELITE	 BEAUMONT/ BEAUMONT ELITE	 CATHEDRAL/ CATHEDRAL ELITE	 CARLTON/ CARLTON ELITE	 SALISBURY/ SALISBURY ELITE	 HORIZON/ HORIZON ELITE	 CHEVRON/ CHEVRON ELITE	 PARADE- WHITE/BROWN
	Spring type	Spring type	Spring type	Spring type	Spring type	Spring type	Spring type	Spring type
6'6"x6'3"	-	-	-	4-401	-	4-401	-	-
6'6"x6'6"	4-402	-	-	4-401	-	4-401	4-401	-
6'6"x7'0"	4-404	-	-	4-402	-	4-402	4-402	-
7'0"x6'3"	-	-	-	4-401	-	4-401	-	-
7'0"x6'6"	4-404	4-402	4-402	4-401	4-404	4-401	4-401	4-402
7'0"x7'0"	4-407	4-405	4-405	4-404	4-405	4-402	4-402	4-404
7'3½"x6'4"	-	-	-	4-401	-	4-401	-	-
7'5"x6'3"	-	-	-	4-402	-	4-401	-	-
7'5"x6'6"	4-404	4-404	4-404	4-402	4-405	4-401	4-402	4-405
7'5"x7'0"	4-407	4-405	4-405	4-404	4-407	4-404	4-404	4-404
7'6"x6'6"	4-404	4-405	4-405	4-402	4-405	4-404	4-402	4-404
7'6"x7'0"	4-407	4-407	4-407	4-405	4-407	4-404	4-404	4-405
7'8½"x6'3"	-	-	-	4-402	-	4-402	-	-
7'8½"x6'6¾"	4-405	4-405	4-405	4-402	-	4-402	4-404	-
7'8½"x6'11¼"	4-407	4-405	4-405	4-405	-	4-405	4-405	-
8'0"x6'3"	-	-	-	4-404	-	4-402	-	-
8'0"x6'6"	4-405	4-405	4-405	4-404	4-407	4-402	-	4-404
8'0"x7'0"	4-407	4-407	4-407	4-405	4-407	4-405	-	4-405
8'2½"x6'3"	-	-	-	4-404	-	4-402	-	-
8'2½"x6'6¾"	-	-	-	4-404	-	4-402	-	4-405
8'2½"x6'11¼"	-	-	-	4-405	-	4-405	-	4-407

F-Type & MK 4 Spring

GRP Premier Panel Doors









Used on all Framed Canopy doors pre 2002. For springs with flat fixing pins part S4-6 is also required. Springs priced and supplied individually. However, it is always recommended that both springs are replaced at the same time.

 <p>£ 55.50 ea.</p>	 STAMFORD Spring type	 ARDEN Spring type	 KENMORE Spring type	 DERWENT Spring type	 SWINTON Spring type	 CLIFTON Spring type	 OAKHAM Spring type	 WOBURN Spring type
	7'0"x6'6"	4-404	4-404	4-404	4-404	4-404	4-404	4-404
7'0"x7'0"	4-405	4-405	4-405	4-405	4-405	4-405	4-405	4-405
7'5"x6'6"	4-405	4-405	4-405	4-405	4-405	4-405	4-405	4-405
7'6"x7'0"	4-405	4-405	4-405	4-405	4-405	4-405	4-405	4-405

F-Type & MK 4 Spring

Timber Panel Doors









Used on all Framed Canopy doors pre 2002. For springs with flat fixing pins part S4-6 is also required. Springs priced and supplied individually. However, it is always recommended that both springs are replaced at the same time.

 <p>£ 55.50 ea.</p>	 CHEVRON CEDAR Spring type	 VERTICAL CEDAR Spring type	 SANDHURST Spring type	 CAVENDISH Spring type	 WOLSEY Spring type	 SEYMOUR Spring type	 TUDOR Spring type	 HORIZONTAL CEDAR Spring type
	7'0"x6'6"	4-402	4-401	4-404	4-404	4-402	4-402	4-402
7'0"x7'0"	4-402	4-402	4-405	4-405	4-404	4-404	4-404	N/A
7'5"x6'6"	4-402	4-402	4-404	4-404	4-404	4-404	4-404	N/A
7'5"x7'0"	4-404	4-402	4-405	4-405	4-405	4-405	4-405	N/A
7'6"x6'6"	4-402	4-402	-	-	4-404	4-404	4-404	-
7'6"x7'0"	4-404	4-402	-	-	4-405	4-405	4-405	-

R, FR & DR Spring

Steel Panel Doors

Used on all FR and R type doors pre 2002 (595 mm long). Springs priced and supplied individually. However, it is always recommended that both springs are replaced at the same time.









 £ 57.00 ea.	 GEORGIAN/ GEORGIAN ELITE	 BEAUMONT/ BEAUMONT ELITE	 CATHEDRAL/ CATHEDRAL ELITE	 CARLTON/ CARLTON ELITE	 SALISBURY/ SALISBURY ELITE	 HORIZON/ HORIZON ELITE	 CHEVRON/ CHEVRON ELITE	 PARADE- WHITE/BROWN
	Spring type	Spring type	Spring type	Spring type	Spring type	Spring type	Spring type	Spring type
6'6"x6'3"	-	-	-	N/A	-	N/A	-	-
6'6"x6'6"	108-901	-	-	108-925	-	108-923	108-923	-
6'6"x7'0"	108-905	-	-	108-927	-	108-925	108-905	-
7'0"x6'3"	-	-	-	N/A	-	N/A	-	-
7'0"x6'6"	108-903	108-901	108-901	108-925	108-903	108-923	108-927	108-901
7'0"x7'0"	108-905	108-903	108-903	108-901	108-907	108-927	108-903	108-903
7'3½"x6'4"	-	-	-	N/A	-	N/A	-	-
7'5"x6'3"	-	-	-	N/A	-	N/A	-	-
7'5"x6'6"	108-903	108-903	108-903	108-927	108-911	108-925	108-925	108-903
7'5"x7'0"	108-907	108-905	108-905	108-907	108-907	108-901	108-901	108-905
7'6"x6'6"	108-907	108-903	108-903	108-903	108-907	108-925	108-907	108-903
7'6"x7'0"	108-911	108-905	108-905	108-907	108-907	108-901	108-911	108-903
7'8½"x6'3"	-	-	-	N/A	-	N/A	-	-
7'8½"x6'6¾"	108-911	108-907	108-907	108-903	-	108-901	108-903	-
7'8½"x6'11¼"	108-913	108-911	108-911	108-903	-	108-903	108-907	-
8'0"x6'3"	-	-	-	N/A	-	N/A	-	-
8'0"x6'6"	108-911	108-907	108-907	108-903	108-907	108-901	-	108-907
8'0"x7'0"	108-913	108-911	108-911	108-909	108-911	108-903	-	108-911
8'2½"x6'3"	-	-	-	N/A	-	N/A	-	-
8'2½"x6'6¾"	-	-	-	-	-	-	-	108-907
8'2½"x6'11¼"	-	-	-	-	-	-	-	108-911
9'0"x6'6"	108-923	-	-	108-913	-	108-913	-	-
9'0"x7'0"	108-925	-	-	108-913	-	108-913	-	-
10'0"x6'6"	108-925	-	-	108-921	-	108-913	-	-
10'0"x7'0"	108-925	-	-	108-923	-	108-921	-	-
11'0"x6'6"	108-927	-	-	108-923	-	108-921	-	-
11'0"x7'0"	108-927	-	-	108-925	-	108-923	-	-
12'0"x6'6"	108-901	-	-	108-925	-	108-923	-	-
12'0"x7'0"	108-903	-	-	108-927	-	108-925	-	-
13'0"x6'6"	108-911	-	-	108-903	-	108-927	-	-
13'0"x7'0"	108-913	-	-	108-907	-	108-901	-	-
14'0"x6'6"	108-913	-	-	108-907	-	108-903	-	108-913
14'0"x7'0"	108-915	-	-	108-911	-	108-907	-	108-915
15'0"x6'6"	-	-	-	108-911	-	108-907	-	-
15'0"x7'0"	-	-	-	108-913	-	108-907	-	-
16'0"x6'6"	-	-	-	108-913	-	108-913	-	-
16'0"x7'0"	-	-	-	108-915	-	108-915	-	-

Last three digits identification stamped onto alloy rag and or spring eye.

R, FR & DR Type Spring

GRP Premier Panel Doors









Used on all FR and R type doors pre 2002

 <p>£ 57.00 ea.</p>	 <p>STAMFORD</p> <p>Spring type</p>	 <p>ARDEN</p> <p>Spring type</p>	 <p>KENMORE</p> <p>Spring type</p>	 <p>DERWENT</p> <p>Spring type</p>	 <p>SWINTON</p> <p>Spring type</p>	 <p>CLIFTON</p> <p>Spring type</p>	 <p>OAKHAM</p> <p>Spring type</p>	 <p>WOBURN</p> <p>Spring type</p>
	7'0"x6'6"	108-907	108-907	108-907	108-907	108-907	108-907	108-907
7'0"x7'0"	108-907	108-907	108-907	108-907	108-907	108-907	108-907	108-907
7'5"x6'6"	108-907	108-907	108-907	108-907	108-907	108-907	108-907	108-907
7'6"x7'0"	108-907	108-907	108-907	108-907	108-907	108-907	108-907	108-907
9'0"x6'6"	108-913	108-913	108-913	-	-	108-913	-	-
9'0"x7'0"	108-913	108-913	108-913	-	-	108-913	-	-
10'0"x6'6"	108-913	108-913	108-913	-	-	108-913	-	-
10'0"x7'0"	108-913	108-921	108-921	-	-	108-921	-	-
11'0"x6'6"	-	108-921	108-921	-	-	-	-	-
11'0"x7'0"	-	108-923	108-923	-	-	-	-	-
12'0"x6'6"	-	108-925	108-925	-	-	-	-	-
12'0"x7'0"	-	108-925	108-925	-	-	-	-	-
14'0"x6'6"	108-901	108-901	108-901	-	-	108-901	-	-

R, FR & DR Type Spring

Timber Panel Doors

Used on all FR and R type doors pre 2002





 <p>£ 57.00 ea.</p>	 <p>CHEVRON CEDAR</p> <p>Spring type</p>	 <p>VERTICAL CEDAR</p> <p>Spring type</p>	 <p>SANDHURST</p> <p>Spring type</p>	 <p>CAVENDISH</p> <p>Spring type</p>	 <p>WOLSEY</p> <p>Spring type</p>	 <p>SEYMOUR</p> <p>Spring type</p>	 <p>TUDOR</p> <p>Spring type</p>	 <p>HORIZONTAL CEDAR</p> <p>Spring type</p>
	7'0"x6'6"	108-901	108-923	-	-	108-903	108-903	108-903
7'0"x7'0"	108-903	108-923	108-907	108-907	108-903	108-903	108-903	N/A
7'5"x6'6"	108-903	108-925	108-903	108-903	108-903	108-903	108-903	N/A
7'5"x7'0"	108-907	108-901	108-907	108-907	109-907	109-907	109-907	N/A
7'6"x6'6"	108-903	108-901	108-903	108-903	108-903	108-903	108-903	-
7'6"x7'0"	108-903	108-901	-	-	108-907	108-907	108-907	-
14'0"x6'6"	-	108-911	108-907	108-907	108-901	108-901	108-901	-
14'0"x7'0"	-	108-911	108-911	108-911	108-903	108-903	108-903	-

<p>Spring Cover Tubes</p> 	
<p>Article</p>	<p>R & DR Spring Cover Tubes (sold in pairs) Suitable for all R, FR and DR springs. Length 595 mm.</p>
<p>Part No.</p>	<p>S7901001-151A</p>
<p>Price £</p>	<p>8.60 ea.</p>

DC Type Spring

Steel Panel Doors

Used on all DC and DR type doors pre 2002 (685 mm long).





 £ 48.00 ea.	 GEORGIAN	 CARLTON	 HORIZON	 PARADE- WHITE/BROWN
	DC Spring	DC Spring	DC Spring	DC Spring
9'0"x6'6"	108-721	108-713	108-709	-
9'0"x7'0"	108-723	108-713	108-713	-
10'0"x6'6"	108-723	108-713	108-709	-
10'0"x7'0"	108-723	108-723	108-713	-
11'0"x6'6"	108-723	108-721	108-713	-
11'0"x7'0"	108-725	108-725	108-723	-
12'0"x6'6"	108-727	108-723	108-721	-
12'0"x7'0"	108-727	108-727	108-725	-
13'0"x6'6"	108-705	108-727	108-725	-
13'0"x7'0"	108-709	108-703	108-727	-
14'0"x6'6"	108-707	108-701	108-727	108-711
14'0"x7'0"	108-711	108-705	108-703	108-713
15'0"x6'6"	-	108-703	108-701	-
15'0"x7'0"	-	108-709	108-705	-
16'0"x6'6"	-	108-707	108-705	-
16'0"x7'0"	-	108-711	108-709	-

Double doors not sold as Elite.

DC Type Spring

GRP Premier Panel Doors







Used on all DC and DR type doors pre 2002

 <p>£ 48.00 ea.</p>	 STAMFORD	 ARDEN	 KENMORE	 CLIFTON
	DC Spring	DC Spring	DC Spring	DC Spring
9'0"x6'6"	108-705	108-705	108-705	108-705
9'0"x7'0"	108-711	108-711	108-711	108-711
10'0"x6'6"	108-711	108-711	108-711	108-711
10'0"x7'0"	108-721	108-721	108-721	108-721
11'0"x6'6"	-	108-713	108-713	-
11'0"x7'0"	-	108-723	108-723	-
12'0"x6'6"	-	108-721	108-721	-
12'0"x7'0"	-	108-725	108-725	-
14'0"x6'6"	108-725	108-725	108-725	108-725

DC Type Spring





Timber Panel Doors



Used on all DC and DR type doors pre 2002





 <p>£ 48.00 ea.</p>	 VERTICAL CEDAR	 SANDHURST	 CAVENDISH	 WOLSEY	 SEYMOUR	 TUDOR
	DC Spring	DC Spring	DC Spring	DC Spring	DC Spring	DC Spring
14'0"x6'6"	108-701	108-707	108-707	108-701	108-701	108-701
14'0"x7'0"	108-701	108-705	108-705	108-703	108-703	108-703



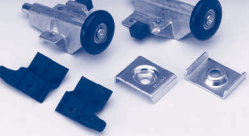

<h3>Spring Cover Tubes</h3>	
Article	DC Spring Cover Tubes (sold in pairs) Suitable for all DC springs. Length 595 mm.
Part No.	S7901001-157A
Price £	8.60 ea.

Cables, Rollers, Spindles

Cables				
Article	C-type pre 1999 (overhead spring) 6'6" (1980 mm) wide door	C-type pre 1999 (overhead spring) 7'0" (2135 mm) to 8'2 1/2" (2500 mm) wide door	C-type pre 1999 (overhead spring) Belgravia doors only (sold in pairs)	C-type 1999-2002 (side extension spring) (Sold in pairs)
Part No.	S9900004-3	P9900004	S9900004-2	SG230-17
Price £	22.50 / pair	22.50 / pair	22.50 / pair	22.50 / pair

Cables			
Article	C-type 2002 - current (Sold in pairs)	Canopy cable drum 2002 - current	Double door top roller and bracket 2002 - current
Part No.	1877015	(LH) 1805003, (RH) 1805004	16867
Price £	19.50 / pair	9.00 ea.	31.50 set

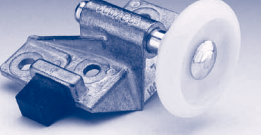
Rollers and spindles				
Article	Rollers & spindles (pair) Overall length 94 mm MK 3 C type only	Rollers & spindles (pair) Overall length 81 mm C type only	'F' type spindle (pair) 'E' clip supplied	Roller spindle assembly (pair) Overall length 87 mm suitable for DC/DR/FR/R
Part No.	S9200010	PST15	SST14	S10601003-17-1
Price £	28.50 / pair	28.50 / pair	22.50 / pair	29.60 / pair

Rollers and spindles				
Article	Roller & spindle assembly (pair) (Side extension spring)	Safety latch & roller (each LH & RH) For canopy doors 2002 - current	Roller bracket assembly For all framed retractable doors 2002 - 2003	Roller bracket assembly For all framed retractable doors 2003 - current
Part No.	SG230-16	(LH) 1891013, (RH) 1891014	(LH) 1284003, (RH) 1284004	(LH) 1084003, (RH) 1084004
Price £	28.50 / pair	20.00 ea.	27.00 ea.	20.00 ea.

Keys, Locking Barrels

Keys			
Article	ZA series keys ¹	92 series keys ¹	CES blanks Suitable for current range ready for cutting
Part No.	0J-KYS-11350	0J-KYS-11360	1019002
Price £	9.00 / pair	9.00 / pair	9.00 / pair

¹ The serial No. Is stamped on the lock, spindle or handle. Key series is either ZA0001 to ZA0200 or 92/201 to 92/400.

Not available for twin latch doors from December 1993.



Locks				
Article	Lock ZA series Includes keys, washers, nuts and bolts. Back face - ZA0001-ZA0200	Lock barrel (1992 - 1998) ² Length 40 mm Steel	Lock barrel (1992 - 1998) ² Length 50 mm T&G Timber	Lock barrel (1992 - 1998) ² Length 70 mm GRP/Elizabethan
Part No.	P15LKS11920	0J-LKS-11881	0J-LKS-11882	0J-LKS-11883
Price £	29.50 ea.	22.00 ea.	28.50 ea.	28.50 ea.

² Keys are not available separately.

Locks		
Article	Euro lock assembly Lock barrels to suit: part nos. 0J-LKS-1181 to 1183	Euro lock assembly Lock barrels to suit: part nos. 0J-LKS-1181 to 1183
Part No.	0J-LKS-11925	0J-LKS-11921
Price £	35.00 ea.	35.00 ea.

Lock body c/w cylinders				
Article	Suitable for all Carlton, Horizon, Salisbury, Chevron & all double steel doors (30.5 + 10)	Suitable for all Georgian, Beaumont, Cathedral, Vertical Cedar and Cavendish doors (35+10)	Suitable for all Tudor, Seymour, Wolsey, Shaftsbury and single GRP doors (40+10)	Suitable for all Sandhurst, Chevron Cedar, Kingsbury, Barrington, Bosworth and all double GRP doors (55.5+10)
Part No.	1019001	1019102	1019103	1019104
Price £	28.40 ea.	28.40 ea.	33.80 ea.	33.80 ea.

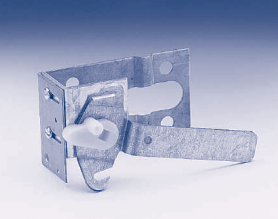
Handle Mechanisms

Handle mechanisms			
Article	Inside handle assembly DR/DC type only up to Dec. 1993 (latch cable only)	Handle conversion kit Includes keys, washer, plastic cups, screws, counterplates, plastic crank, slit bolt & nut	T-handle assembly Includes keys, washer, slit bolt & nut, plastic cups and screws. Key no. between 201 & 400
Part No.	SR001-60	S1731040-1DP	S1731040-10 (Black)
Price £	20.50 ea.	42.00 ea.	35.50 ea.



Handle mechanisms				
Article	Outside handle black Length 75 mm 1992 - 1998	Outside handle black Length 115 mm 1992 - 1998	Outside handle brass Length 75 mm 1992 - 1998	Outside handle brass Length 115 mm 1992 - 1998
Part No.	S1731040-22	S1731040-23	S1731040-33	S1731040-32
Price £	13.50 ea.	13.50 ea.	26.50 ea.	26.50 ea.



Handle mechanisms				
Article	Black handle - single door Black 1998 - April 2002	Brass handle - single door Brass 1998 - April 2002	Black handle - double door Black 1998 - April 2002	Brass handle - double door Brass 1998 - April 2002
Part No.	BLK-HAND-S	BRS-HAND-S	BLK-HAND-L	BRS-HAND-L
Price £	19.50 ea.	27.50 ea.	22.00 ea.	30.50 ea.

Handle mechanisms				
Article	Euro lock handle (complete) Black 75 mm July 1998 - April 2002	Euro lock handle (complete) Brass 75 mm July 1998 - April 2002	Euro lock handle (complete) Black 115 mm July 1998 - April 2002	Euro lock handle (complete) Brass 115 mm July 1998 - April 2002
Part No.	OJ-HDL-11705	OJ-HDL-11706	OJ-HDL-11715	OJ-HDL-11716
Price £	39.00 ea.	55.50 ea.	44.00 ea.	61.00 ea.

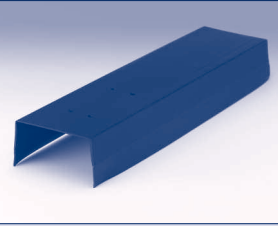
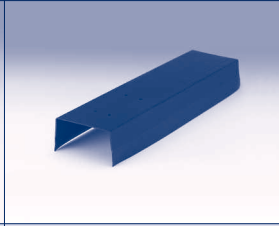
Handle Mechanisms, Weatherseals

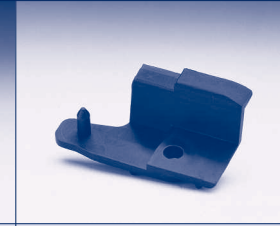
Handle mechanisms				
Article	Standard black handle All steel doors 2002 - current	Standard black handle (adjustable & fascia) All timber & GRP doors 2002 - current	Additional lock kit For canopy doors 2003 - current	Additional lock kit For retractable doors 2003 - current
Part No.	550	232	HM063-3	HM063-4
Price £	10.50 ea.	18.00 ea.	44.00 ea.	44.00 ea.

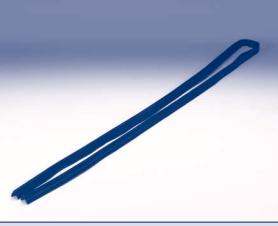
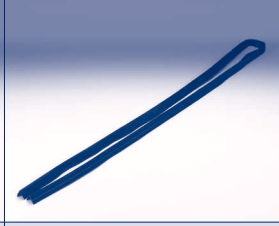
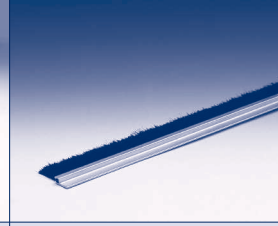
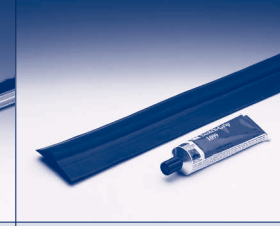

Cover profiles & Pivot blocks				
Article	Finger trap protection For retractable doors 2004 - current	Finger trap protection For retractable plus doors 2005 - current	Pivot block (frame) 2004 - current	Pivot block (panel) For retractable doors 2004 - current
Part No.	1248010-1	1844	(LH) 1045501, (RH) 1045502	(LH) 1082503, (RH) 1082504
Price £	9.50 ea.	9.50 ea.	9.00 ea.	10.50 ea.

Weatherstrips			
Article	Canopy door top weatherstrip 2002 - current	Canopy door bottom weatherstrip 2002 - current (cut to length)	Retractable top weatherstrip Specify height of door when ordering
Part No.	1883600-1	1846100-1	1882000-1, 1882000-2
Price £	11.50 ea.	11.50 ea.	11.50 ea.

Weather seals				
Article	Bottom weather seal Length 2405 mm	Bottom weather seal Length 3000 mm	Brushstrip Approx. 2.5 m long	Glue down rubber weatherseal Approx. 2.5 m long
Part No.	1578435	1578487	OF-BRU-70000	OF-WSL-70001
Price £	25.00 ea.	29.00 ea.	25.00 ea.	27.00 ea.

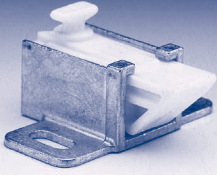
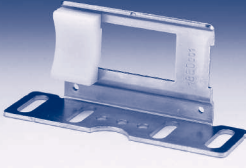

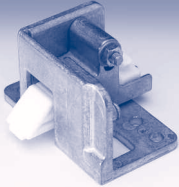
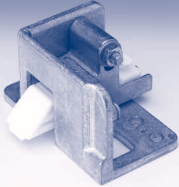
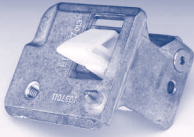

Latches

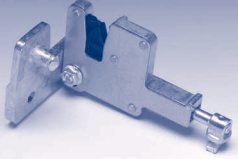
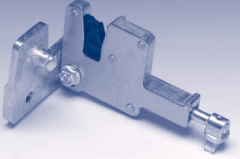
Latches			
Article	Canopy door latch assembly Pre 2002	Canopy door latch assembly 2002 - current	Canopy door latch keeper 2002 - current
Part No.	SLFG3	1161005	1860000
Price £	13.50 ea.	8.50 ea.	8.00 ea.

Latches				
Article	Retractable latch For steel doors 2002 - 2003	Retractable latch For GRP doors 2002 - 2006	Adjustable retractable latch For steel doors 2003 - 2005	Adjustable retractable latch For timber doors 2003 - 2005 & GRP doors (gold in colour) 2000 - current
Part No.	(LH) 1037213, (RH) 1037214	(LH) 1037213, (RH) 1037214	(LH) 1037313, (RH) 1037314	(LH) 1148313, (RH) 1148314
Price £	22.00 ea.	22.00 ea.	22.00 ea.	22.00 ea.

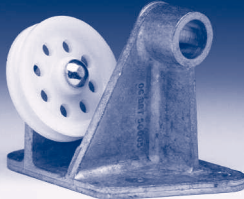

Latches		
Article	Retractable latch For steel doors 2005 - current	Retractable latch For timber doors 2005 - current & GRP doors (gold in colour) 2006 - current
Part No.	(LH) 2790, (RH) 2791	(LH) 3076, (RH) 3077
Price £	22.00 ea.	22.00 ea.

C & F Type Accessories

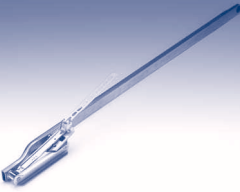

C Type				
Article	S-Hook 1999 - 2002	Link arm (bare) Supplied with clip 1999 - 2002	Wall bracket assembly 1999 - 2002	Spring anchor bracket 1999 - 2002
Part No.	0H-HOK-11130	(LH) SG230-11L, (RH) SG230-11R	(LH) SG230-13L, (RH) SG230-13R	SG230-25
Price £	7.00 ea.	22.00 ea.	17.00 ea.	8.50 ea.

C Type				
Article	Track & slider assembly 1999 - 2002	Side unit cover 1999 - 2002	C Type link arm	Link arm Supplied with pin spacer and washer Up to March 2002
Part No.	(LH) SG230-14L, (RH) SG230-14R	0I-EXT-11004	SLA1, SLA2	(LH) SLA3, (RH) SLA4
Price £	17.00 ea.	17.00 ea.	34.00 ea.	34.00 ea.

F Type				
Article	Guide wheels & brackets Left Hand Up to March 2002	Guide wheels & brackets Right Hand Up to March 2002	Spring anchor top pin Up to March 2002	Strut This component is not handed and is suitable for either side. Up to March 2002
Part No.	S4-18-1	S4-18-2	S4-6	SST9
Price £	14.00 ea.	14.00 ea.	12.00 ea.	56.00 ea.



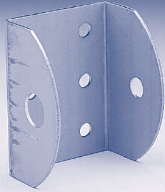

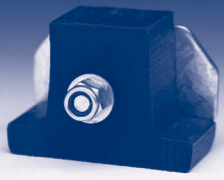
Retractable Single Sized Doors				
Article	Retractable link arm assembly For steel frame 6'6" 2002 - current	Retractable link arm assembly For steel frame 7'0" 2002 - current	Retractable link arm assembly For timber frame 6'6" 2002 - current	Retractable link arm assembly For timber frame 7'0" 2002 - current
Part No.	(LH) HM069-1, (RH) HM069-2	(LH) HM069-3, (RH) HM069-4	(LH) HM068-1, (RH) HM068-2	(LH) HM068-3, (RH) HM068-4
Price £	28.00 ea.	28.00 ea.	35.00 ea.	35.00 ea.

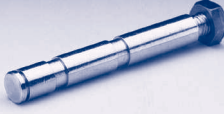
DR, R, FR & DC Type Accessories

DR, R, FR & DC Type				
Article	Roller bracket (on door) Suitable for DC/DR from 1988 to 2002	Link arm assembly Suitable for R/FR/DR from 1998 to 2002	Spring anchor pin E-Clip supplied (sold individually) Suitable for DC/DR/FR/R	Rubber stop DC type only from 1992
Part No.	S10601002-10R	SG250-3	S108-159	SG240-23
Price £	8.00 ea.	87.50 ea.	11.00 ea.	11.00 ea.



DR, R, FR & DC Type				
Article	Spring anchor bracket from 1988 to 2002	Link arm assembly Up to & inc 7'0" high E-Clip supplied with both items Suitable for DC	Link arm assembly Over 7'0" high E-Clip supplied with both items Suitable for DC	Spring anchor pin Suitable for R/FR/DR from 1988 to 2002
Part No.	S10800008	S108-153R	S108-152R	SG250-8
Price £	10.50 ea.	87.50 ea.	87.50 ea.	9.00 ea.



Track Assembly				
Article	DR track	DC track Up to 7'	DC track Over 7'	Canopy track assembly (Includes cable & roller) 2002 - current
Part No.	(LH) 108-971-1, (RH) 108-971-2	(LH) 108-976-1, (RH) 108-976-2	(LH) 108-977-1, (RH) 108-977-2	(LH) HM065-1, (RH) HM065-2
Price £	48.00 ea.	90.00 ea.	99.00 ea.	46.00 ea.





Track assembly				
Article	Retractable track assembly ¹ up to 10' wide - 6'6" high only 2002 - current	Retractable track assembly ¹ up to 10' wide - 7'0" high only 2002 - current	Retractable track assembly ¹ over 10' wide - 6'6" high 2002 - current	Retractable track assembly ¹ over 10' wide - 7'0" high 2002 - current
Part No.	(LH) 271, (RH) 272	(LH) 273, (RH) 274	(LH) 197500001, (RH) 197600001	(LH) 197500002, (RH) 197600002
Price £	33.00 ea.	33.00 ea.	45.00 ea.	45.00 ea.

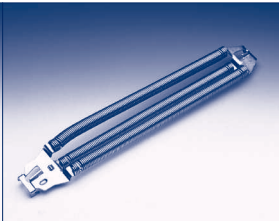

¹Please specify steel or timber framed option when ordering.

Springs



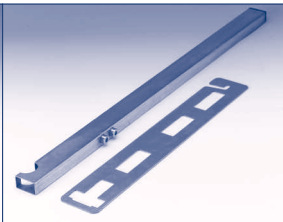
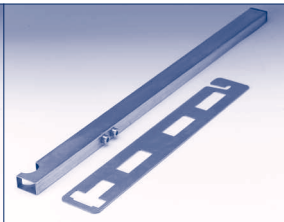

Springs canopy doors		
Article	Canopy spring assembly (State door size when ordering) 2002 - current	Canopy tensioning bars
Part No.	HM067	OG-TOM-50000
Price £	77.00 ea.	13.50 set of two

Springs retractable & retractable plus doors			
Article	Retractable spring assembly 001 2002 - current	Retractable spring assembly 002 2002 - current	Retractable spring assembly 003 2002 - current
Part No.	1195001	1195002	1195003
Price £	70.00 / pair	70.00 / pair	70.00 / pair

Springs double doors				
Article	Double door spring assembly 615 2004 - current	Double door spring assembly 621 2004 - current	Double door spring assembly 4er 025 2004 - current	Double door spring assembly 4er 032 2004 - current
Part No.	1195615	1195621	1195025	1195032
Price £	89.00 / pair	89.00 / pair	89.00 / pair	89.00 / pair

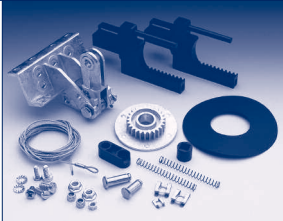

Springs double doors				
Article	Double door spring assembly 612 2004 - current	Double door spring assembly 623 2004 - current	Tensioning tool For all single retractable doors 2002 - current	Tensioning tool For double retractable doors 2008 - current
Part No.	1195612	1195623	1907	1909
Price £	89.00 / pair	89.00 / pair	64.00	64.00

Spares for current range of Electric Operators

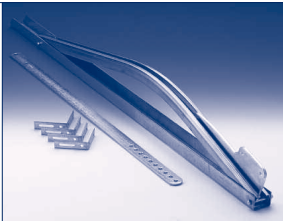
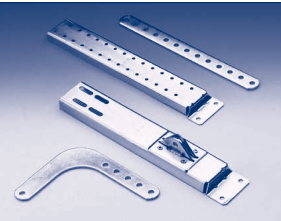
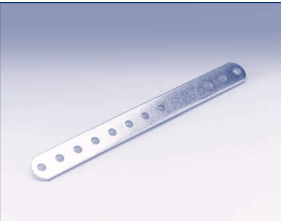
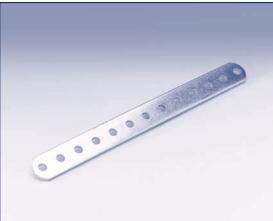
Delatching kits & Emergency releases				
Article	Delatching kit For all single & double retractable doors	Emergency release For retractable doors with lock and handle	Emergency release For sectional doors with lock and handle	Emergency release Canopy doors or sectional doors without handles
Part No.	437.197	437.205	437.183	437.190
Price £	41.00 ea.	33.50 ea.	40.00 ea.	40.00 ea.

Canopy bow arms				
Article	Bow arm For canopy doors	Reinforcing kit For sectional doors	Extended towing arm 258 mm long	Extended towing arm 495 mm long
Part No.	436.273	436.099	438.384	438.742
Price £	73.50 ea.	49.00 ea.	14.00 ea.	33.50 ea.



Radio receiver & transmitters				
Article	HS4 Grey buttons 40 mHz	HSM4 Grey buttons 40 mHz	HSE2 Grey buttons 40 mHz	Radio Receiver Grey button 40 mHz
Part No.	437.602	437.312	437.322	437.050
Price £	49.00 ea.	49.00 ea.	49.00 ea.	67.50 ea.

Receiver		
Article	Receiver IP65 40 mHz	Receiver IP65 868 mHz
Part No.	437.063	437.408
Price £	155.00 ea.	155.00 ea.

Radio Receivers, Transmitters, Autodor Spares

Radio receiver & transmitters				
Article	HS4 Blue buttons 868 mHz	HSM4 Blue buttons 868 mHz	HSE2 Blue buttons 868 mHz	Radio receiver Blue button 868 mHz
Part No.	437.572	437.446	437.456	437.404
Price £	47.00 ea.	47.00 ea.	47.00 ea.	67.50 ea.

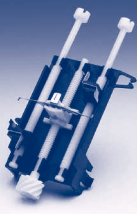

Autodor spares				
Article	Autodor Elite printed circuit board 27 mHz	Autodor Elite printed circuit board 418 mHz	Autodor printed circuit board 27 mHz	Autodor printed circuit board 418 mHz
Part No.	DF-AUT-90031	DF-AUT-90051	DF-AUT-90011	DF-AUT-90041
Price £	150.00 ea.	150.00 ea.	150.00 ea.	150.00 ea.

Autodor spares			
Article	Printed circuit board 433 mHz	Autodor Elite limit assembly	Autodor limit assembly
Part No.	DF-AUT-43306	DF-AUT-90030	DF-AUT-90019
Price £	150.00 ea.	22.00 ea.	24.50 ea.

Autodor spares				
Article	3 Channel key fob 433 mHz	Autodor Elite trolley rack	Single channel handset 433 mHz	Single channel handset 27 mHz
Part No.	DF-AUT-43304	DF-AUT-90054	DF-AUT-43301	DF-AUT-72000
Price £	55.00 ea.	28.50 ea.	50.00 ea.	50.00 ea.

Consumables

Bulbs			
Article	Bulb Suitable for M2 and Expert	Bulb Suitable for GaraMatic 10 & 20 operators	Bulb Suitable for GaraMatic 7 & 9 operators Auto Expert
Part No.	2641	4643	715
Price £	6.00 ea.	8.50 ea.	5.50 ea.

Batteries			
Article	Battery Suitable for HS2/HSM2, HS4 and HSM4	Battery Suitable for HSE2	Battery Suitable for wall consoles etc.
Part No.	2522	2521	4644
Price £	7.50 ea.	7.50 ea.	7.00 ea.

Door Stays	
Article	Side-hung door stays
Part No.	2449
Price £	52.00 / pair

Care

A Garador garage door needs only a minimum level of preparation and maintenance to give years of trouble-free service. Below is a guide to how to get the best from your garage door.

Operation

- For opening the door in manual operation use only the outside handle or inside handle. Never use the pull rope during the opening cycle of the door.
- For closing the door from the outside – the pull rope fixed to the internal handle is only designed to pull the door towards you whilst standing within the entrance of the garage until the door can be pushed down by hand, then using the external handle for final closing.
- For closing the door from the inside – the pull rope already mentioned is designed to be pulled away from you, when facing the front entrance of the garage, until the internal handle is able to be reached, by hand, and used for final closing. The pull rope is not designed to be used for any other part of the operating cycle, or any other purpose. Failure to comply with the above instructions may result in injury to persons or property.
- When the door is operated from either outside or inside, check the area through which the door will travel is clear from people and objects. Failure to do so may result in injury to persons or property.
- When closing, ensure the latches engage properly.
- If the door is power-operated always try to ensure you match the door with a Garador electric operator to ensure full compliance with the Machinery Directive. If another make must be used always consider any compatibility/compliance issues.

Cleaning

- The door, and frame if applicable, should be washed with a mild soap-based solution on a regular basis to prevent the build up of dirt, salts and other corrosive substances and help maintain the aesthetic appearance of the product.
- If the door is installed in a seafront location, the door panel and frame should be cleaned in this way at least every two months.
- We also suggest that all other components be brushed down on a regular basis to prevent the build up of dirt and dust etc.

Locking

- If the key is turned completely, the door is then locked or unlocked; when unlocked it is then possible to open and close the door by turning the handle.
- If the key is turned 1/4 of the way, the door opened and then the key returned to its start position, the door will re-lock when closed.
- By moving the internal locking "snib", it is possible to lock and unlock the door from the inside without using the key.

Maintenance

- If in doubt about any of these maintenance procedures below always consult a Garador specialist. Garador Ltd. has a nationwide network of installers who will be able to offer you a regular maintenance service on your garage door. Please call Garador or refer to the Garador website for further details of your nearest installer.
- Immediately after the door is fitted and after every 5,000 operations of the door, or at least once a year, oil all pivot points, check screws and clamped connections for tightness, keep the running tracks clean (do not grease them), check parts and replace any worn components where necessary.
- The springs should be replaced after approx. 25,000 operations by an experienced door fitter (see fitting and operation instructions).
- Do not oil the lock cylinder; if it is sticking, only lubricate with graphite dust.
- For canopy doors only, check the cable every 6 months with normal usage (8 operations per day). Have the cables replaced by an expert if any wear is found.

Finish – Steel Doors

The coating process applied to the door and chassis is environmentally friendly. Minor scratches or marks are not covered under the conditions of our warranty and should be repaired immediately to prevent corrosion and deterioration of the panel. Corrosive such as acids, alkalines, and salts, etc. should be cleaned from the door immediately; failure to do so will result in deterioration of the finish, which will not be covered under our warranty. If you choose to paint your powder coated door then prepare the surface lightly with wet and dry. Then treat with two coats of a normal commercial paint for external use (cellulose paints must not be used).

Finish – Timber Doors

Timber doors are supplied poly-wrapped, and the timber panels coated with a neutralising base-stain (except Cavendish, which is supplied untreated). Doors must be stored upright, under cover, with wrapping intact, until wrapping is removed. As soon as the door is unwrapped, one coat of a good quality basecoat primer must be applied to both sides of the door. Immediately after installation, your timber doors require a further two coats of a good quality exterior wood finish on both sides. Initial application and periodic treatment should be carried out strictly in accordance with the woodstain manufacturer's instructions. Failure to follow these instructions will result in early deterioration of the timber panel.

Finish – GRP Doors

GRP door panels should periodically washed down using water. This should be done more frequently if fitted near the sea. Bird droppings will bleach the finish on GRP, and should be removed using water as soon as possible. GRP doors should not be painted over.

Paint Finish – Steel Doors

Garador steel doors are a finished product. They do not require re-painting on site. They are however not immune to damage, which can occur at any stage of the handling of the product from factory to site. Minor surface damage can easily be repaired using touch up sprays or sticks without invalidating warranties. For extra peace of mind, order your steel door poly-wrapped at the factory to help prevent damage from occurring prior to installation.

Warranty

Garador products are manufactured to the highest quality standards and leave our factory only after rigorous quality testing. However, if you should have grounds for complaint, this section tells you what our door warranty offers, and how to go about making your claim.

In the unlikely event of a warranty claim becoming necessary, please contact the dealer or distributor who originally supplied your garage door. Your dealer should then supply details of the claim, together with a copy of the warranty card provided with the door and proof of purchase to the Warranty Department at Garador Ltd.

To enable your claim under warranty to be processed as quickly as possible, you should provide the following details:

- 1 Your name, address and telephone number
- 2 Original invoice with date of purchase
- 3 Product description/door type and product number
- 4 Description of defect

An assessment of the claim will then be made. This may require Garador to inspect the product in-situ. In the event that there is no legitimate warranty claim under the terms specified herein, you may be liable for the costs of the inspection visit. We strongly recommend that you take note of the care and usage instructions displayed on the stickers on the back of your garage door, and on the page opposite, and that you follow these instructions throughout.

Garador installers Garador Ltd. has a nationwide network of recommended installers who will be able to offer you a regular maintenance service on your garage door. Please call us on 0800 706670 or refer to the Garador website for further details of your nearest installer.

Garador Garage Door Warranty

Warranty Period

The purchaser is granted a warranty covering the safe and reliable function of the Garador garage door for a period of 10 years from the date of purchase. The warranty period for replacement parts is 6 months or to the end of the current warranty period, whichever is longer.

In the case of foil-coated timber-effect doors, a warranty of 5 years is granted, for timber and GRP doors a warranty of 2 years is granted on the door panels alone under the terms and conditions specified herein. The door mechanism and steel frame (if applicable) is covered by the 10 year warranty period.

Requirements

Warranty claims are only applicable in the country where the garage door was purchased. The product must have been purchased through our authorised distribution channels. The warranty only covers damage to the contract object. The fully completed warranty card together with the receipt of purchase correspondingly dated substantiates your right to claim under the warranty.

Performance

During the warranty period we undertake to rectify any and all defects to the Garador product which can be proved to be attributed to a material or manufacturing fault. We pledge at our discretion either to exchange the defective merchandise for faultless merchandise, repair it or allow a reduction in price. We do not accept costs for dismantling and installation nor for carriage. Replaced parts become our property.

The warranty does not cover damage caused through:

- normal wear and tear
- improper installation
- negligent care and maintenance
- improper initial and subsequent operation
- negligent or wanton destruction
- external influences such as fire, water, salts, alkaline solutions, acids, abnormal environmental influences
- mechanical damage through improper transport and fitting
- priming and other surface protection treatments
- incorrect or too late applied surface protection treatments
- repair by non-qualified persons
- using non-Garador parts without the approval of the manufacturer
- remove of the product number or making it unidentifiable

Electric Operator Warranty

A separate 5 year warranty is granted on our electric operators. This includes operator mechanics, motor and motor control systems. A 2 year warranty is granted on radio equipment, accessories and system controls. There is no warranty on consumables (e. g. fuses, batteries, bulbs etc.). For further details please contact us on 0800 706670, or through our website on www.garador.co.uk

Extracts from AGDS consumer advice

The following document was designed by the Association of Garage Door Specialists and endorsed by all major UK garage door manufacturers, as a guide for purchasers of domestic garage doors.

VISUAL APPEARANCE OF GARAGE DOORS

A new garage door can be a significant investment that will transform the appearance of your home. This information is a guide to the quality you can expect.

THE QUALITY CHECK

The quality check should be carried out in natural daylight, not direct sunlight. Stand at a distance of 3 metres from the door to view the overall appearance.

The door is acceptable if, taking into account the facts below, none of the following are readily visible on the face of the door:

- Marks or distortion associated with the manufacturing process
- Minor indentations, marks or scuffs on the surface
- Paint or stain blemishes

THE FACTS

STEEL DOORS

Panel Distortion The rolling or pressing of steel panels during manufacture will cause distortion in the steel and while every effort is made to keep this to a minimum, inevitably some visible distortion will remain. The application of high gloss paints will make this slight distortion more apparent, especially under certain lighting conditions, such as car headlamps, or bright sunshine.

Paint Finish Primed doors – the primer coating is applied as a base coat only and as such requires additional finishing with a good quality exterior paint. Any marks or scratches on the primer coat should be rubbed down and repainted as part of this finishing process.

Finished doors – the factory application of the paint finish is an automated process and this may result in minor blemishes or slight inconsistencies in the paint, particularly in the area of panel joints.

TIMBER DOORS

Timber Timber is a natural product and there will be variations in pattern, colour, shading and grains. No two doors will be the same. Because wood naturally expands and contracts according to environmental conditions, joints will open and close and some minor curvature may occur.

Finishing It is vital that timber doors are fully finished as per the manufacturers instructions before exposure to the elements.

GRP AND COMPOSITE PLASTIC DOORS

Mould Marks GRP doors are individually handcrafted in a mould and are then hand finished. Some minor marks and blemishes will inevitably remain after this process.

Translucency When viewed from the inside, it is often possible to see variations in the translucency of the door, particularly around and between areas of relief. Such variations do not detract from the overall strength or build quality of the door.

ALL DOORS

Colour Match Pairs of doors should be ordered together to obtain the best colour match, bearing in mind the limitations of the materials used in the construction. Timber garage doors cannot be ordered as matching sets.

Size Variations As the size of a door changes in height and/or width, the panel frequency and profile can change, therefore doors of the same style but of different sizes can be significantly different in appearance.

Clearances All doors require operating clearances, i.e. the gap between the door panel and the frame opening, these are inbuilt during manufacture and should not be reduced by means of infills, or draughtproofing.

Deflection When in the open position, all doors will display a level of vertical deflection or 'sag' across the width of the panel. Individual manufacturers' specifications should be consulted for exact tolerances.



This page is reproduced with the kind permission of the Association of Garage Door Specialists. For further details on the AGDS, go to www.agds.co.uk.

Since the company's policy is one of continuous improvement of its products, we reserve the right to make any alterations in design, manufacture or price. All business is governed by the company's Standard Conditions and this document does not form any part of any contract with the company and statements contained in it should not be construed as representations or warranties.