

NEW ThermoPlus Styles



Series 2000 Entrance Door Price List

01.09.2015



Notes and Sketches

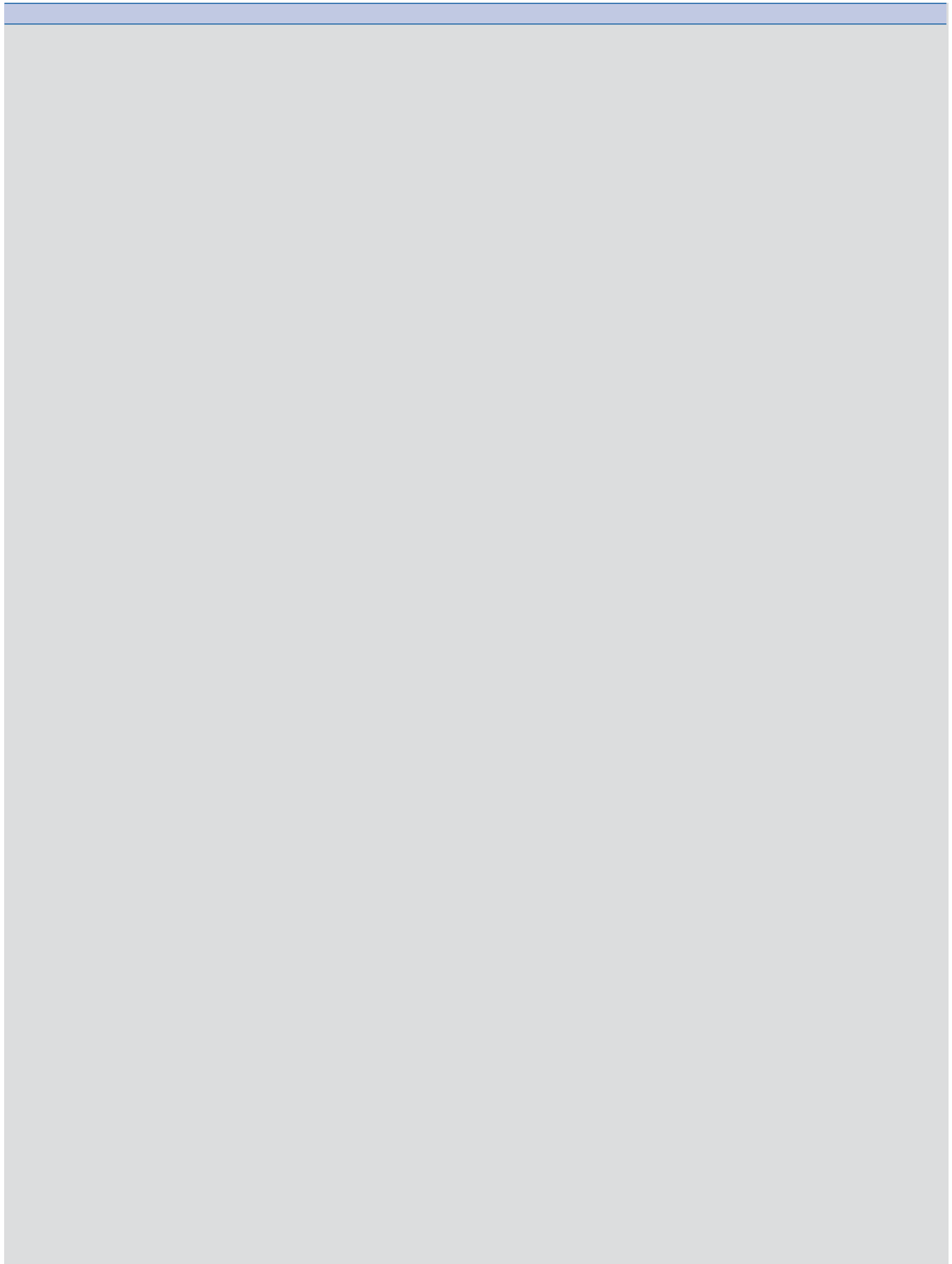

ThermoPro Entrance Doors / ThermoPlus Entrance Doors



Contents

ThermoPro entrance doors		From page
TPS		
TPS product description and technical presentation		4-7
TPS entrance doors		8-9
Accessories for TPS entrance doors		10-15
Side elements and transom lights		16
Overview of panels / glass for side elements		17
ThermoPlus entrance doors		
THP		
THP product description and technical presentation		18-23
THP entrance doors		24-25
THP entrance door accessories		26-31
Side elements and transom lights		32
Overview of glass for side elements		33
Steel security doors		From page
KSi Thermo		34
Steel multi purpose doors		From page
MZ Thermo		35
Accessories for MZ Thermo		36
MZ ThermoPlus		37
Accessories for MZ ThermoPlus		38

For further information on ThermoPro and
ThermoPlus entrance doors see our brochure.

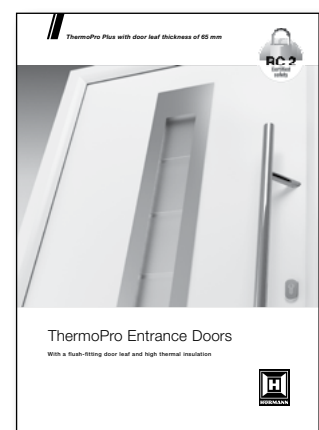

ThermoPro Entrance Doors

Entrance door programme

Product description



Product description	Steel ThermoPro TPS																										
	010	015	020	025	030	040	100	200	400	700	750	900															
Door leaf structure																											
Smooth sheet "Modern"	●		●		●	●				●	●	●															
Ribbed sheet "Modern"		●		●																							
Panelled sheet "Classic"							●	●	●																		
Door leaf thickness	46 mm thick																										
Fully foamed With thermal break Exterior and interior overlapping the leaf	●	●	●	●	●	●	●	●	●	●	●	●															
Size ranges (see also page 6)																											
Standard sizes (overall frame size)	1000 × 2100 mm and 1100 × 2100 mm																										
Special sizes (overall frame size)	"Modern" type A						"Classic"			"Modern" type B																	
875 – 1250 mm Width 1875 – 2250 mm Height	●	●	●	●	●	●				●	●	●															
875 – 1100 mm Width 1875 – 2186 mm Height							●		●																		
875 – 1100 mm Width 1990 – 2186 mm Height								●																			
Surface																											
Standard	<ul style="list-style-type: none"> Painted in Traffic white on both sides, based on RAL 9016 Silk matt, gloss level 35 – 40 % 																										
Colour	<ul style="list-style-type: none"> 15 preferred colours Painted on both sides, based on the RAL colour chart Silk matt, gloss level 35 – 40 % <table border="0"> <tr> <td>RAL 1015 Light ivory</td> <td>RAL 6005 Moss green</td> <td>RAL 8028 Terra brown</td> </tr> <tr> <td>RAL 3000 Flame red</td> <td>RAL 7016 Anthracite grey</td> <td>RAL 9001 Cream</td> </tr> <tr> <td>RAL 3003 Ruby red</td> <td>RAL 7035 Light grey</td> <td>RAL 9002 Grey white</td> </tr> <tr> <td>RAL 5010 Gentian blue</td> <td>RAL 7040 Window grey</td> <td>RAL 9006 White aluminium</td> </tr> <tr> <td>RAL 5014 Pigeon blue</td> <td>RAL 8003 Clay brown</td> <td>RAL 9007 Grey aluminium</td> </tr> </table>												RAL 1015 Light ivory	RAL 6005 Moss green	RAL 8028 Terra brown	RAL 3000 Flame red	RAL 7016 Anthracite grey	RAL 9001 Cream	RAL 3003 Ruby red	RAL 7035 Light grey	RAL 9002 Grey white	RAL 5010 Gentian blue	RAL 7040 Window grey	RAL 9006 White aluminium	RAL 5014 Pigeon blue	RAL 8003 Clay brown	RAL 9007 Grey aluminium
RAL 1015 Light ivory	RAL 6005 Moss green	RAL 8028 Terra brown																									
RAL 3000 Flame red	RAL 7016 Anthracite grey	RAL 9001 Cream																									
RAL 3003 Ruby red	RAL 7035 Light grey	RAL 9002 Grey white																									
RAL 5010 Gentian blue	RAL 7040 Window grey	RAL 9006 White aluminium																									
RAL 5014 Pigeon blue	RAL 8003 Clay brown	RAL 9007 Grey aluminium																									
Foil-coating, both sides	Golden Oak	●	●	●	●	●	●				●	●	●														
	Dark Oak	●	●	●	●	●	●				●	●	●														
	Night Oak	●	●	●	●	●	●				●	●	●														
	Winchester Oak	●	●	●	●	●	●				●	●	●														
	Titan Metallic CH 703	●	●	●	●	●	●				●	●	●														
Seals																											
4-sided, double EPDM seals, black, with continuous lip seal in the bottom sheet, additional EPDM form parts in both bottom corners for additional sealing, incl. brush seal in the frame	●	●	●	●	●	●	●	●	●	●	●	●															
Lock																											
Multiple-point locking with main lock (with soft-lock latch) and 2 bolts, pivoting/hook bolt combination	●	●	●	●	●	●	●	●	●	●	●	●															
Electric strike																											
Electric strike with day catch (separate)	○	○	○	○	○	○	○	○	○	○	○	○															
Security bolts																											
3x anti-leverage guard	●	●	●	●	●	●	●	●	●	●	●	●															
Version in RC 2																											
Attack side = opposite hinge side																											
RC 2 with aluminium frame, hook bolt lock, profile cylinder with drilling and pull-off protection as well as security card	○	○					○																				
RC 2 with aluminium frame, hook bolt lock, profile cylinder with drilling and pull-off protection as well as security card and safety glass A3 (P4A)										○	○	○															
Thermal insulation value (in W/(m²·K))																											
► Dependent on the size and frame type	For a product description, see page 4 to 7																										

- Standard
○ Optional

ThermoPro Entrance Doors

Entrance door programme

Product description



Product description	Steel ThermoPro TPS												
	010	015	020	025	030	040	100	200	400	700	750	900	
Fittings													
Hinges													
- 3 two-part guide rollers (180 mm), 3-way adjustable with cover caps (stainless steel look)	●	●	●	●	●	●	●	●	●	●	●	●	●
Door handle (exterior)													
- Exterior handle HB 14-2, brushed stainless steel	●	●	●	●	●	●	●	●	●	○	○	○	
- Exterior handle HB 38-2, brushed stainless steel	○	○	○	○	○	○	○	○	○	●	●	●	
Door handle (interior)													
- Stainless steel lever handle	●	●	●	●	●	●	●	●	●	●	●	●	●
Rose escutcheon (exterior and interior)													
- Oval stainless-steel profile cylinder rose escutcheons	●	●	●	●	●	●	●	●	●	●	●	●	●
Profile cylinder													
- Cylinder length 35.5 x 27.5 mm with 5 keys	●	●	●	●	●	●	●	●	●	●	●	●	●
Glazing frame													
• Round-style plastic, clipped			●	●	●	●							
• Profile-style plastic, clipped - With surface-mounted plastic rails								●	●				
• Stainless steel, bonded										●	●	●	
Glazing													
• Double-pane insulated glazing, 26 mm thick, exterior laminated safety glass – interior Mastercarré single-pane safety glass			●	●	●								
• Double-pane insulated glazing, 26 mm thick, exterior laminated safety glass – interior single-pane safety ornamental glass 504 with fine structure						●							
• Double-pane insulated glazing, 24 mm thick, exterior laminated safety glass – interior single-pane safety cathedral glass with small hammered finish								●					
• Double-pane insulated glazing, 26 mm thick, exterior laminated safety glass – interior single-pane safety cathedral glass with small hammered finish									●				
• Triple-pane insulated glazing, 44 mm thick, exterior laminated safety glass – float sand-blasted with clear stripes – interior single-pane safety glass										●	●	●	
Frame													
• Aluminium block frame with aluminium/ plastic threshold, with thermal break, colour matching the door leaf	●	●	●	●	●	●	●	●	●	●	●	●	●
Side element/transom light													
• For doors opening inwards	○	○	○	○	○	○	○	○	○	○	○	○	○

- Standard
○ Optional

Note:

For doors with dark surfaces, the material expansion is particularly high. Therefore, please check the location of the door in the building in your consultation meeting. This will ensure trouble-free door operation.

ThermoPro Entrance Doors

Entrance door programme

Technical presentation of door set



TPS entrance doors with aluminium frame (profile A1 shown in the drawing)

Standard sizes		
Overall frame dimension Ordering size	Structural opening	Clear frame dimension
1000 x 2100	1020 x 2110	872 x 2016
1100 x 2100	1120 x 2110	972 x 2016

Special sizes		
TPS Styles	Overall frame dimension	
	Width	Height
010/015/040	875 - 1250	1875 - 2250
020/025/030	875 - 1250	1875 - 2250
100/400	875 - 1100	1875 - 2186
200	875 - 1100	1990 - 2186
700/750/900	875 - 1250	1875 - 2250

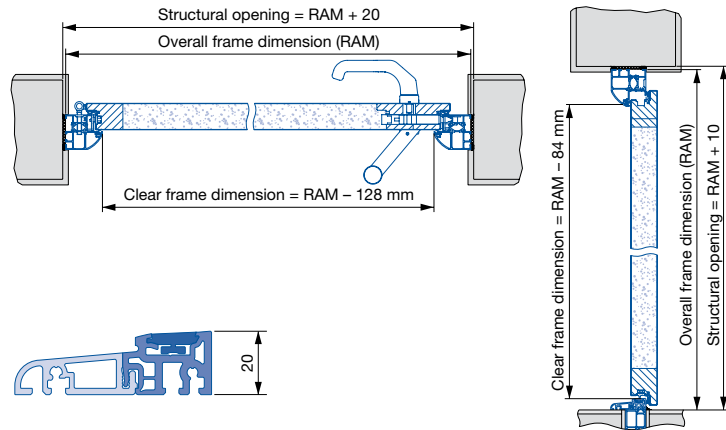

Wall connections for frames

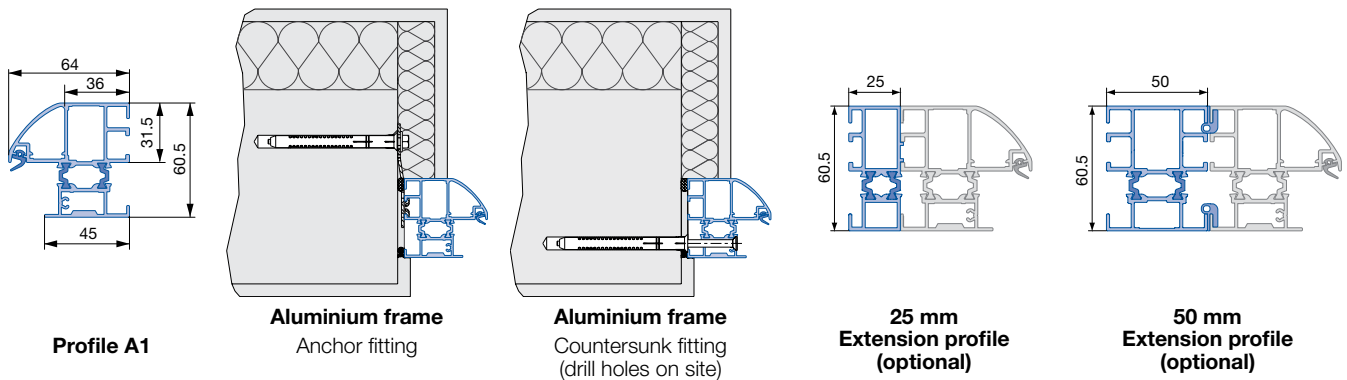

Wall connections for frames

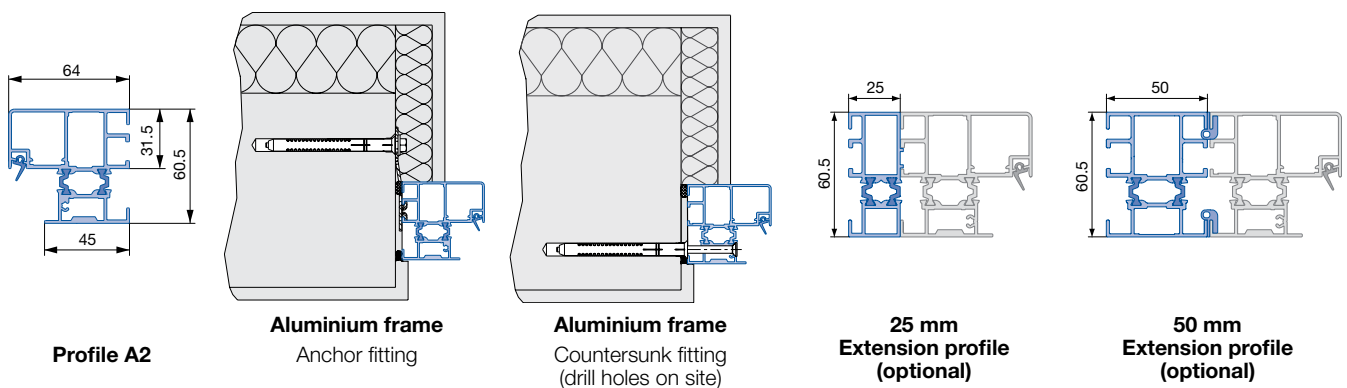

ThermoPro Entrance Doors

Entrance door programme

Technical presentation of door set with side element / transom light



TPS entrance doors with side element/transom light

Standard sizes – Side element		
TPS Styles	Overall frame dimension	
	Width	Height
010/015/020/025/030/040/700/750/900	400	2100
100/200/400	450	2100

Special sizes – Side element		
TPS Styles	Overall frame dimension	
	Width	Height
010/015/040	See pages 16 and 17	
020/025/030/700/750/900		
100/200/400		

Size range – Transom light		
TPS Styles	Overall frame dimension	
	Width	Height
All styles	See page 16	

Clear view		
	Width	Height
Side element	RAM side element – 116	RAM side element – 138
Transom light	RAM transom light – 116	RAM transom light – 116

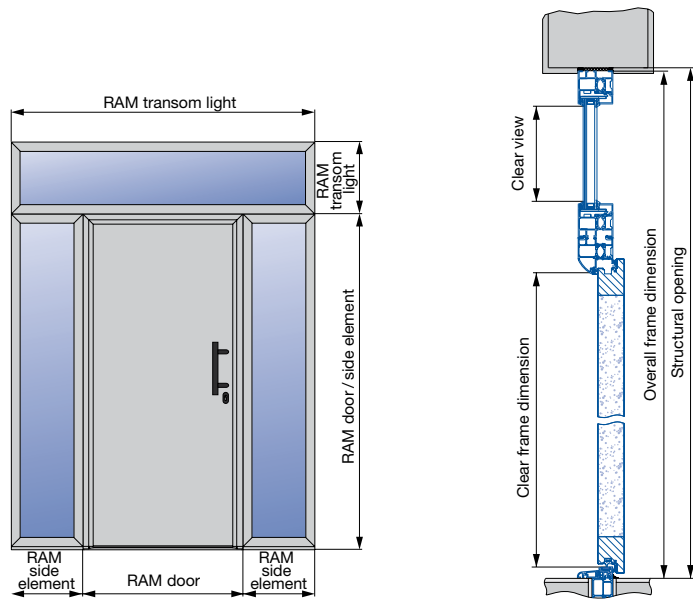
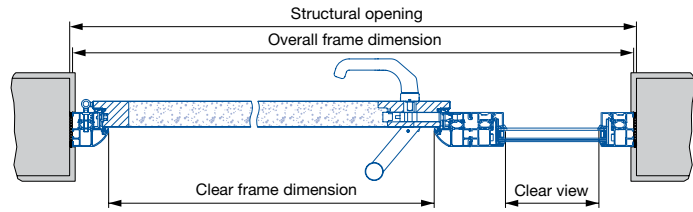
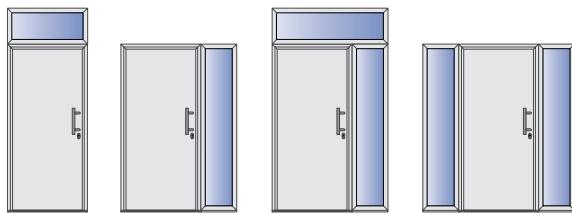

Clear view for styles with glazing

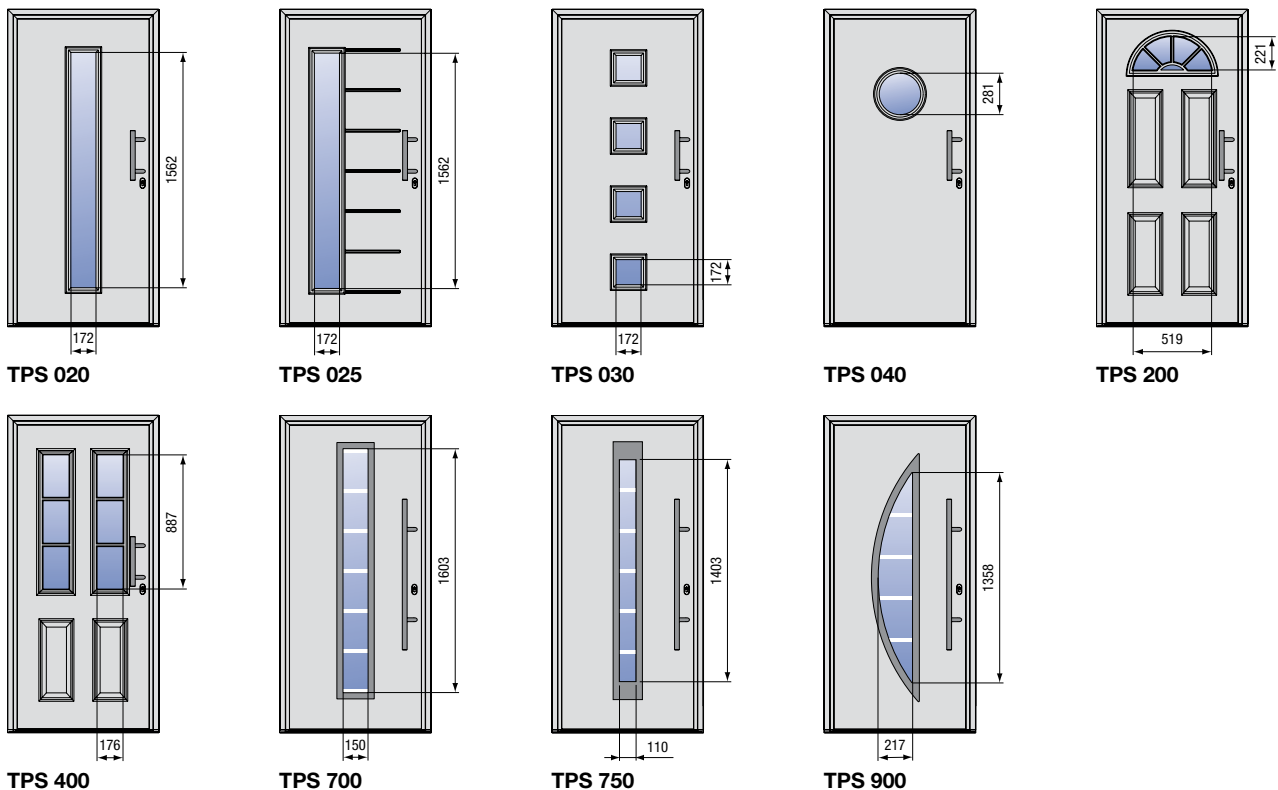

Steel ThermoPro Entrance Doors

Entrance door programme



For a product description, see from page 4

- Steel door leaf overlapping the frame, with thermal break, exterior and interior in same colour
- Aluminium frame
- Multiple-point lock

Colour 15 preferred colours (see page 4)

Decor Golden Oak, Dark Oak, Night Oak, Winchester Oak and Titan Metallic CH 703

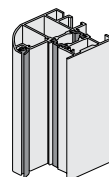

Profile A1

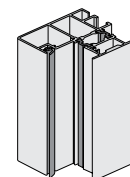

Profile A2

View	Style description	Size (RAM)	RAL 9016	Colour	Decor	RAL 9016	Colour	Decor
	Style TPS 010 <ul style="list-style-type: none"> • Smooth sheet • Handle HB 14-2 	1000 × 2100 1100 × 2100	874	1053	1087	926	1104	1138
		From 875 × 1875 Up to 1250 × 2250	1159	1337	1371	1210	1388	1422
▶ U _D -value for size 1230 × 2180 mm: 1.1 W/(m ² ·K)								
	Style TPS 015 <ul style="list-style-type: none"> • Ribbed sheet • Handle HB 14-2 	1000 × 2100 1100 × 2100	940	1118	1152	991	1169	1204
		From 875 × 1875 Up to 1250 × 2250	1225	1403	1437	1276	1454	1489
▶ U _D -value for size 1230 × 2180 mm: 1.1 W/(m ² ·K)								
	Style TPS 020 <ul style="list-style-type: none"> • Smooth sheet • 2 panes of insulated glass, Mastercarré single-pane safety glass and clear laminated safety glass • Plastic glazing frame in door leaf colour (exception: decor surface finish*) • Handle HB 14-2 	1000 × 2100 1100 × 2100	1198	1588	1623	1249	1639	1674
		From 875 × 1875 Up to 1250 × 2250	1481	1872	1907	1533	1923	1958
▶ U _D -value for size 1230 × 2180 mm: 1.4 W/(m ² ·K)								
	Style TPS 025 <ul style="list-style-type: none"> • Ribbed sheet • 2 panes of insulated glass, Mastercarré single-pane safety glass and clear laminated safety glass • Plastic glazing frame in door leaf colour (exception: decor surface finish*) • Handle HB 14-2 	1000 × 2100 1100 × 2100	1262	1652	1687	1313	1703	1738
		From 875 × 1875 Up to 1250 × 2250	1547	1937	1972	1598	1988	2023
▶ U _D -value for size 1230 × 2180 mm: 1.4 W/(m ² ·K)								
	Style TPS 030 <ul style="list-style-type: none"> • Smooth sheet • 2 panes of insulated glass, Mastercarré single-pane safety glass and clear laminated safety glass • Plastic glazing frame in door leaf colour (exception: decor surface finish*) • Handle HB 14-2 	1000 × 2100 1100 × 2100	1265	1655	1690	1316	1706	1741
		From 875 × 1875 Up to 1250 × 2250	1550	1940	1975	1601	1991	2026
▶ U _D -value for size 1230 × 2180 mm: 1.3 W/(m ² ·K)								
	Style TPS 040 <ul style="list-style-type: none"> • Smooth sheet • 2 panes of insulated glass, single-pane safety ornamental glass 504 with fine structure and clear laminated safety glass • Plastic glazing frame in door leaf colour (exception: decor surface finish*) • Handle HB 14-2 	1000 × 2100 1100 × 2100	1173	1564	1599	1225	1615	1650
		From 875 × 1875 Up to 1250 × 2250	1458	1849	1884	1510	1900	1935
▶ U _D -value for size 1230 × 2180 mm: 1.2 W/(m ² ·K)								

* For decor door surface finishes, the plastic glazing frames are coated in a colour matching the decor.

Accessories and optional extras

See from page 10

Steel ThermoPro Entrance Doors

Entrance door programme



For a product description, see from page 4

- Steel door leaf overlapping the frame, with thermal break, exterior and interior in same colour
- Aluminium frame
- Multiple-point lock

Colour 15 preferred colours (see page 4)



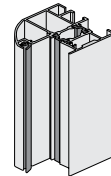

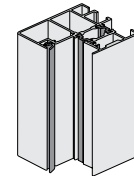

Decor Golden Oak, Dark Oak, Night Oak, Winchester Oak and Titan Metallic CH 703



Profile A1



Profile A2

View	Style description	Size (RAM)	RAL 9016	Colour	Decor	RAL 9016	Colour	Decor
	Style TPS 100 <ul style="list-style-type: none"> • Panelled sheet • Handle HB 14-2 	1000 × 2100 1100 × 2100	899	1077	-	950	1128	-
		From 875 × 1875 Up to 1100 × 2186	1183	1362	-	1235	1413	-
▶ U _D -value for size 1230 × 2180 mm: 1.1 W/(m ² ·K)								
	Style TPS 200 <ul style="list-style-type: none"> • Panelled sheet • 2 panes of insulated glass, cathedral single-pane safety glass with small hammered finish and clear laminated safety glass • Plastic glazing frame with surface-mounted rails • Handle HB 14-2 	1000 × 2100 1100 × 2100	990	1380	-	1041	1431	-
		From 875 × 1990 Up to 1100 × 2186	1275	1665	-	1326	1716	-
▶ U _D -value for size 1230 × 2180 mm: 1.2 W/(m ² ·K)								
	Style TPS 400 <ul style="list-style-type: none"> • Panelled sheet • 2 panes of insulated glass, cathedral single-pane safety glass with small hammered finish and clear laminated safety glass • Plastic glazing frame with surface-mounted rails • Handle HB 14-2 	1000 × 2100 1100 × 2100	1058	1448	-	1109	1500	-
		From 875 × 1875 Up to 1100 × 2186	1342	1732	-	1393	1783	-
▶ U _D -value for size 1230 × 2180 mm: 1.5 W/(m ² ·K)								
	Style TPS 700 <ul style="list-style-type: none"> • Smooth sheet • 3 panes of insulated glass, clear single-pane safety glass, sand-blasted float with clear horizontal stripes and clear laminated safety glass • Stainless steel glazing frame • Handle HB 38-2 	1000 × 2100 1100 × 2100	1564	1742	1776	1615	1794	1828
		From 875 × 1875 Up to 1250 × 2250	1849	2027	2061	1900	2078	2113
▶ U _D -value for size 1230 × 2180 mm: 1.3 W/(m ² ·K)								
	Style TPS 750 <ul style="list-style-type: none"> • Smooth sheet • 3 panes of insulated glass, clear single-pane safety glass, sand-blasted float with clear horizontal stripes and clear laminated safety glass • Stainless steel glazing frame • Handle HB 38-2 	1000 × 2100 1100 × 2100	1564	1742	1776	1615	1794	1828
		From 875 × 1875 Up to 1250 × 2250	1849	2027	2061	1900	2078	2113
▶ U _D -value for size 1230 × 2180 mm: 1.2 W/(m ² ·K)								
	Style TPS 900 <ul style="list-style-type: none"> • Smooth sheet • 3 panes of insulated glass, clear single-pane safety glass, sand-blasted float with clear horizontal stripes and clear laminated safety glass • Stainless steel glazing frame • Handle HB 38-2 	1000 × 2100 1100 × 2100	1705	1884	1918	1756	1935	1969
		From 875 × 1875 Up to 1250 × 2250	1989	2168	2202	2040	2219	2253
▶ U _D -value for size 1230 × 2180 mm: 1.2 W/(m ² ·K)								

Accessories and optional extras

See from page 10

ThermoPro Entrance Doors

Entrance door programme

Accessories



Exterior door handles (included in door price) £

Handle HB 14-2

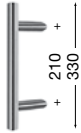

- Brushed stainless steel
- Standard with styles TPS 010, TPS 015, TPS 020, TPS 025, TPS 030, TPS 040, TPS 100, TPS 200 and TPS 400

Surcharge for conversion
of handle HB 14-2 to handle HB 38-2

102

Handle HB 38-2



- Brushed stainless steel
- Standard with styles TPS 700, TPS 750 and TPS 900

Surcharge for conversion
of handle HB 38-2 to handle HB 14-2

102

Calculation example £

**Conversion
TPS 020 with HB 14-2
to
HB 38-2**

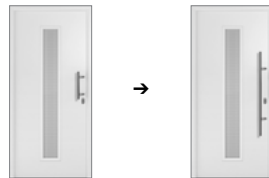

Style TPS 020 in RAL 9016 with profile A1 (standard size) **1198**
+ Conversion from handle HB 14-2 to handle HB 38-2 **102**
= Total **1300**

**Conversion
TPS 700 with HB 38-2
to
Fitting ES 1**

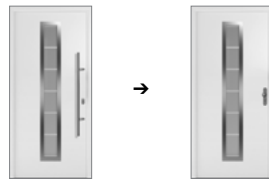

Style TPS 700 in RAL 9016 with profile A1 (standard size) **1564**
+ Surcharge for ES 1 stainless steel knob/lever fitting **276**
= Total **1840**

ES 0 fittings Including profile cylinder with 5 keys Surcharges £

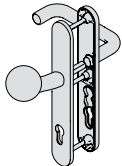

Knob / lever

Stainless steel

Each

102

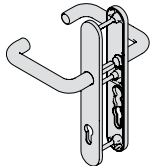

Lever / lever

Stainless steel

Each

102

ES 1 fittings Including profile cylinder with 5 keys Surcharges £

Note: ES 1 fittings are only possible from a RAM of 900 mm for style TPS 400.

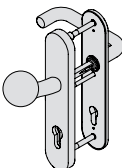

Knob / lever

Stainless steel

Each

276

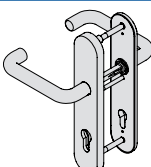

Lever / lever

Stainless steel

Each

276

ThermoPro Entrance Doors

Entrance door programme

Accessories



Advanced handle and letter plate options for styles TPS 100, TPS 200 and TPS 400					£
Gold or silver aluminium sleeved letter plate only TPS 100, TPS 200 and TPS 400					36
Gold or silver lever set tested to PAS 24 with drill resistant cylinder escutcheon only TPS 100, TPS 200 and TPS 400					41
Gold or silver outside knob inside lever only TPS 100, TPS 200 and TPS 400					37
Gold or silver outside knob inside lever tested to PAS 24 with drill resistant cylinder escutcheon only TPS 100, TPS 200 and TPS 400					49
Profile cylinder					£
	Profile cylinder (35.5 + 27.5 mm) For HB 14-2 and HB 38-2 push bars	With 8 keys	Each	44	
		With 10 keys	Each	52	
	Profile cylinder (40.5 + 31.5 mm) For ES 0 fittings	With 5 keys	Each	30	
		With 8 keys	Each	44	
		With 10 keys	Each	52	
Profile cylinder (40.5 × 31.5 mm), with drilling and pull-off protection For fittings ES 1 and push bar with security rose escutcheon ES 1	With 5 keys	Each	66		
	With 8 keys	Each	91		
	With 10 keys	Each	113		
Profile cylinder, keys to pass, with drilling and pull-off protection with security card	With 5 keys	Each	87		
	With 8 keys	Each	111		
	With 10 keys	Each	136		
Note: No keys to pass for the profile cylinder from the fitting package					
Rose escutcheon					£
	Exterior oval rose escutcheon (screwed)			Each	38
Profiles					£
	Bottom spacer profile	Length up to 1250 mm	Height 30 mm	Each	20
			Height 60 mm	Each	39
			Height 90 mm	Each	58
			Height 120 mm	Each	77
			Height 150 mm	Each	96
		Length up to 2250 mm	Height 30 mm	Each	34
			Height 60 mm	Each	67
			Height 90 mm	Each	100
			Height 120 mm	Each	133
			Height 150 mm	Each	166
		Length up to 3250 mm	Height 30 mm	Each	48
			Height 60 mm	Each	95
			Height 90 mm	Each	142
			Height 120 mm	Each	189
			Height 150 mm	Each	236
	Extension profile 25 mm Dimensions (W × D): 25 × 60.5 mm	RAL 9016	Per m	42	
		Colour	Per m	50	
		Golden Oak, Dark Oak, Night Oak, Winchester Oak, Titan Metallic CH 703	Per m	53	

ThermoPro Entrance Doors

Entrance door programme

Accessories





Profiles				£
	Extension profile 50 mm Dimensions (W x D): 50 x 60.5 mm	RAL 9016	Per m	47
		Colour	Per m	55
		Golden Oak, Dark Oak, Night Oak, Winchester Oak, Titan Metallic CH 703	Per m	59
	Cover profile Per package 2 x 2300 mm and 1 x 1300 mm Dimensions (W x D): 50 x 5 mm Profiles sufficient for a door without side elements/transom light	RAL 9016	Per box	95
		Golden Oak, Dark Oak, Night Oak, Winchester Oak, Titan Metallic CH 703	Per box	127
	Supplementary profile Width 20 mm, mitred, incl. corner bracket and fitting screws	RAL 9016	Each	195
		Colour	Each	246

ThermoPro Entrance Doors

Entrance door programme

Accessories

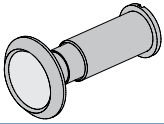
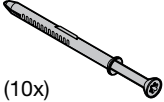
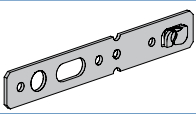
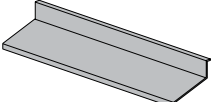
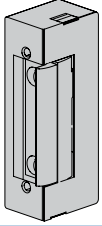
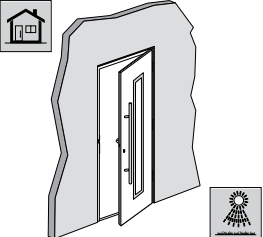

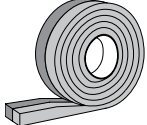
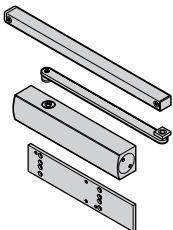
Accessories		£
	Spyhole (only for TPS 010, TPS 015 and TPS 100)	Each 46
 (10x)	Fitting set 10x screws and 10x plugs	Per set 21
	Screw-in anchor set Length 280 mm (8 x anchors)	Per set 23
	Rain canopy Anodised aluminium	Each 21
	Electric strike with day catch (separate)	Each 64
	Door set opening outwards (all approved characteristics will no longer apply!)	Per door 61
	Stainless steel cleaner and care product (150 ml)	Each 26
	Pre-compressed sealing strip (56 mm wide) for groove widths from 6 – 15 mm 5.90 m roll (approved for RAL fitting)	Per roll 69
Door closers		£
	Door leaf prepared for overhead door closer (reinforcement in door leaf)	Each 30
	Overhead door closer HDC 35 for fitting on the hinge side For ThermoPro entrance doors with aluminium frame, profile A1 or A2	Each 178
	Overhead door closer HDC 35 for fitting on the opposite hinge side For ThermoPro entrance doors with aluminium frame, profile A2	Each 178
	Mechanical hold-open device	Each 69

ThermoPro Entrance Doors





Entrance door programme

Accessories

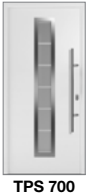

Entrance door in RC 2 version (for a product description, see page 4) £

Attack side = opposite hinge side

			Package HB 14-2 with security rose escutcheon	Stainless steel	Per door	217
			ES 1 fittings	Knob / lever	Stainless steel	Per door 276
				Lever / lever	Stainless steel	Per door 276
			Package HB 38-2 with security rose escutcheon and safety glass A3 (P4A)	Stainless steel	Per door	328
			Fittings ES 1 and safety glass A3 (P4A)	Knob / lever	Stainless steel	Per door 387
				Lever / lever	Stainless steel	Per door 387

Example for calculating an entrance door in an RC 2 version £

**Conversion
TPS 700 with HB 38-2
to
Package HB 38-2 with
security rose escutcheon**

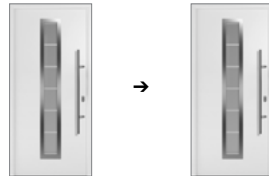

Style TPS 700 in RAL 9016 with profile A1 (standard size)	1564
+ Conversion for package HB 38-2 with security rose escutcheon	328
= Total	1892

Secured By Design option £

Secured by Design



Official Police Security Initiative

Secured by Design in conjunction with the Association of Chief Police Officers, is a security upgrade to help combat crime. The fully accredited door will come supplied with a high security cylinder complete with registration card and 3 security keys.

91

Available on styles 100, 700, 900, 010, 030, 040 and 015

ThermoPro Entrance Doors

Entrance door programme

Accessories



Embellishments in stainless steel look (on the exterior)

£



TPS 015



TPS 025

Embellishment in stainless steel look view 400

- For style 015 (inlay length 577 mm per rib)
- For style 025 (inlay length 351 mm per rib)

Per door

150

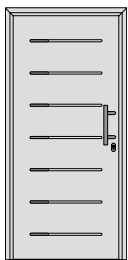

TPS 015

Embellishment in stainless steel look view 401

- For style 015 (inlay length 118 mm per rib)

Per door

150

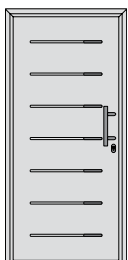

TPS 015

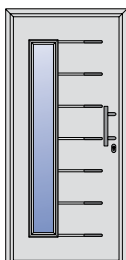

TPS 025

Embellishment in stainless steel look view 402

- For style 015 (inlay length 118 mm per rib)
- For style 025 (inlay length 118 mm per rib)

Per door

150

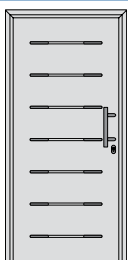

TPS 015

Embellishment in stainless steel look view 403

- For style 015 (inlay length 2 x 118 mm per rib)

Per door

150

Stainless steel bottom sheet (on the exterior)

£

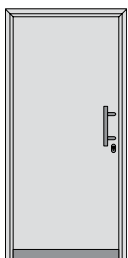

TPS 015

Stainless steel bottom sheet

- Bottom sheet height 110 mm
- Size range of heights for style

Style	Height (RAM)
010/040	1875–2250 mm
015/020/025/030/100/ 200/400/700/750/900	2050–2250 mm

Per door

141

ThermoPro Entrance Doors

Entrance door programme

Side elements and transom lights



Side element

Fixed side element assembly

Standard size

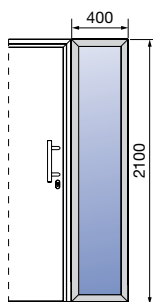

Ordering sizes RAM (mm) Width x height	Glass	RAL 9016	Colour	Decor
400 x 2100	Mastercarré	603	700	732
	Clear glass	603	700	732
	Sand-blasted float	603	700	732
	Ornamental glass 504	603	700	732
	Cathedral glass	603	700	732
	Sand-blasted float with clear stripes	1125	1223	1255

Side element

Fixed side element assembly

Special sizes

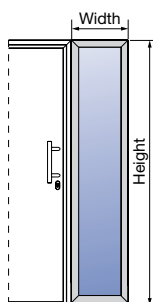

Ordering sizes RAM up to (mm) Width x height	Glass	RAL 9016	Colour	Decor
From 300 x 1875 to 500 x 2250	Clear glass, Mastercarré, ornamental glass 504, cathedral glass	750	847	879
to 1000 x 2250 *	or sand-blasted float according to overview on page 17	895	992	1024
From 300 x 1875 to 500 x 2250	Sand-blasted float with clear stripes according to overview on page 17	1273	1370	1402
to 1000 x 2250 *		1417	1515	1547

* Only possible without transom light

Door set with side element does not have a statics function. Statics must be ensured by the building structure.

Side element

Fixed side element assembly for "Classic" styles

Special size

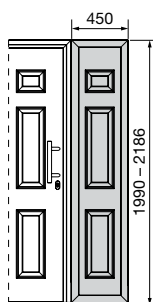

Ordering sizes RAM (mm) Width x height	Panel/glass	RAL 9016	Colour
From 450 x 1875 to 450 x 2186	Panel <i>without</i> glass in accordance with the overview on page 17	521	618
From 450 x 1875 to 450 x 2186	Panel <i>with</i> glass in accordance with the overview on page 17	575	672

Transom light

Fixed transom light assembly

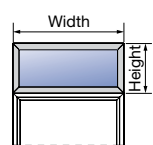





Ordering sizes RAM (mm) Width x height	Glass	RAL 9016	Colour	Decor
From 875 x 300 to 1250 x 500	Clear glass, Mastercarré, ornamental glass 504, cathedral glass	566	665	698
to 2250 x 500	or sand-blasted float according to overview on page 17	750	847	879

ThermoPro Entrance Doors

Entrance door programme

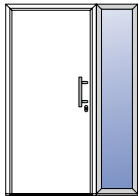
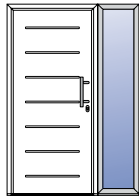
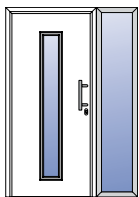
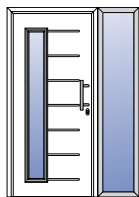
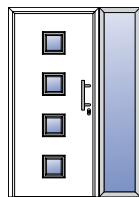
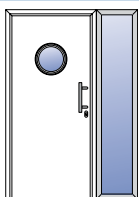
Overview of panels/glass for side elements

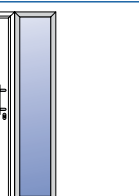

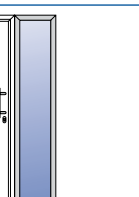
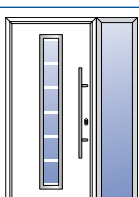
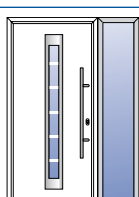
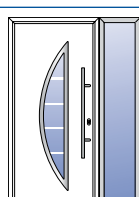
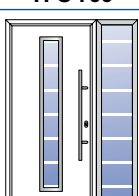
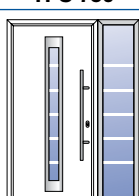
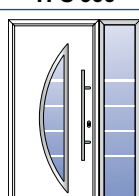
Infill/size range						
	Style			Glass	Size range	
					Side element	Transom light
"Modern" type A				1. Clear lamin. safety glass / Mastercarré single-pane safety glass 2. Clear lamin. safety glass / single-pane safety ornamental glass 504 3. Clear laminated safety glass / sand-blasted laminated safety glass (without clear stripes) 4. Clear laminated safety glass / clear laminated safety glass	Width 300 – 1000 mm Height 1875 – 2250 mm	Width 875 – 2250 mm Height 300 – 500 mm
				1. Clear lamin. safety glass / Mastercarré single-pane safety glass 2. Clear laminated safety glass / clear laminated safety glass	Width 300 – 1000 mm Height 1990 – 2250 mm	Width 875 – 2250 mm Height 300 – 500 mm
				1. Clear lamin. safety glass / single-pane safety ornamental glass 504 2. Clear laminated safety glass / clear laminated safety glass	Width 300 – 1000 mm Height 1875 – 2250 mm	Width 875 – 2250 mm Height 300 – 500 mm
"Classic"				1. Element with 3 panels 2. Clear laminated safety glass / clear laminated safety glass 3. Clear lamin. safety glass / single-pane safety cathedral glass	Width Panel: 450 mm Glass: 300 – 1000 mm Height 1875 – 2186 mm	Width 875 – 2000 mm Height 300 – 500 mm
				1. Element with 1 panel and glazing cut-out with clear laminated safety glass / single-pane safety cathedral glass 2. Clear laminated safety glass / clear laminated safety glass 3. Clear lamin. safety glass / single-pane safety cathedral glass	Width Panel: 450 mm Glass: 300 – 1000 mm Height 1875 – 2186 mm	Width 875 – 2000 mm Height 300 – 500 mm
"Modern" type B				1. Clear laminated safety glass / sand-blasted laminated safety glass (without clear stripes) 2. Clear laminated safety glass / clear laminated safety glass 3. Clear laminated safety glass / sand-blasted laminated safety glass with clear stripes (only in side element)	Width 300 – 1000 mm Height 1875 – 2250 mm	Width 875 – 2250 mm Height 300 – 500 mm
						

ThermoPlus Entrance Doors

Entrance door programme

Product description



Product description	ThermoPlus – steel THP																																					
	010	015	700	750	800	810	850	900																														
Door leaf structure																																						
Smooth sheet	●		●	●	●	●	●	●																														
Ribbed sheet		●																																				
Door leaf thickness	65 mm thick																																					
Fully foamed With thermal break Exterior and interior overlapping the leaf	●	●	●	●	●	●	●	●																														
Size ranges (see also page 20)																																						
Standard sizes (overall frame size)	1000 × 2100 mm and 1100 × 2100 mm																																					
Special sizes (overall frame size)	875 – 1250 mm Width	1875 – 2250 mm Height	●	●	●	●	●	●																														
Surface																																						
Standard	<ul style="list-style-type: none"> Painted in Traffic white on both sides, based on RAL 9016 Silk matt, gloss level 35 – 40 % 																																					
Colour	<ul style="list-style-type: none"> 15 preferred colours Painted on both sides, based on the RAL colour chart Silk matt, gloss level 35 – 40 % <table border="0"> <tr> <td>RAL 1015</td><td>Light ivory</td> <td>RAL 6005</td><td>Moss green</td> <td>RAL 8028</td><td>Terra brown</td> </tr> <tr> <td>RAL 3000</td><td>Flame red</td> <td>RAL 7016</td><td>Anthracite grey</td> <td>RAL 9001</td><td>Cream</td> </tr> <tr> <td>RAL 3003</td><td>Ruby red</td> <td>RAL 7035</td><td>Light grey</td> <td>RAL 9002</td><td>Grey white</td> </tr> <tr> <td>RAL 5010</td><td>Gentian blue</td> <td>RAL 7040</td><td>Window grey</td> <td>RAL 9006</td><td>White aluminium</td> </tr> <tr> <td>RAL 5014</td><td>Pigeon blue</td> <td>RAL 8003</td><td>Clay brown</td> <td>RAL 9007</td><td>Grey aluminium</td> </tr> </table>								RAL 1015	Light ivory	RAL 6005	Moss green	RAL 8028	Terra brown	RAL 3000	Flame red	RAL 7016	Anthracite grey	RAL 9001	Cream	RAL 3003	Ruby red	RAL 7035	Light grey	RAL 9002	Grey white	RAL 5010	Gentian blue	RAL 7040	Window grey	RAL 9006	White aluminium	RAL 5014	Pigeon blue	RAL 8003	Clay brown	RAL 9007	Grey aluminium
RAL 1015	Light ivory	RAL 6005	Moss green	RAL 8028	Terra brown																																	
RAL 3000	Flame red	RAL 7016	Anthracite grey	RAL 9001	Cream																																	
RAL 3003	Ruby red	RAL 7035	Light grey	RAL 9002	Grey white																																	
RAL 5010	Gentian blue	RAL 7040	Window grey	RAL 9006	White aluminium																																	
RAL 5014	Pigeon blue	RAL 8003	Clay brown	RAL 9007	Grey aluminium																																	
Foil-coating, both sides	Golden Oak	●	●	●	●	●	●	●																														
	Dark Oak	●	●	●	●	●	●	●																														
	Night Oak	●	●	●	●	●	●	●																														
	Winchester Oak	●	●	●	●	●	●	●																														
	Titan Metallic CH 703	●	●	●	●	●	●	●																														
Seals																																						
<ul style="list-style-type: none"> Door leaf: 4-sided, double seals Frame: 3-sided seals 	●	●	●	●	●	●	●	●																														
Lock																																						
<ul style="list-style-type: none"> Multiple-point locking with main lock (with soft-lock latch) and 2 bolts, pivoting / hook bolt combination Main lock plate with adjustable latch slot Secondary lock plates with eccentric adjustment 	●	●	●	●	●	●	●	●																														
Electric strike																																						
Electric strike with day catch (separate)	○	○	○	○	○	○	○	○																														
Security bolts																																						
Security strip on the hinge side	●	●	●	●	●	●	●	●																														
Version in RC 2																																						
Attack side = hinge side or opposite hinge side																																						
RC 2 with aluminium frame, hook bolt lock, profile cylinder with drilling and pull-off protection as well as security card and guide rollers	○	○																																				
RC 2 with aluminium frame, hook bolt lock, profile cylinder with drilling and pull-off protection as well as security card, guide rollers and safety glass P4A			○	○	○	○	○	○																														
RC 2 with side element/transom light (P4A safety glass)	○	○	○	○	○	○	○	○																														
Thermal insulation value (in W/(m²·K))																																						
► Dependent on the size and frame type	For a product description, see above																																					

- Standard
○ Optional

ThermoPlus Entrance Doors

Entrance door programme

Product description

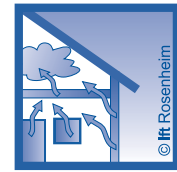

Product description	ThermoPlus – steel THP							
	010	015	700	750	800	810	850	900
Fittings								
Hinges								
<ul style="list-style-type: none"> 3 two-part guide rollers (180 mm) 3-way adjustable With cover caps (stainless steel look) With securing pins 	●	●	●	●	●	●	●	●
Door handle (exterior)								
<ul style="list-style-type: none"> Exterior handle HB 14-2, brushed stainless steel Exterior handle HB 38-2, brushed stainless steel 	●	●	○	○	○	○	○	○
Door handle (interior)								
<ul style="list-style-type: none"> Stainless steel lever handle 	●	●	●	●	●	●	●	●
Rose escutcheon (exterior and interior)								
<ul style="list-style-type: none"> Oval stainless-steel profile cylinder rose escutcheons 	●	●	●	●	●	●	●	●
Profile cylinder								
<ul style="list-style-type: none"> Cylinder length 40.5 x 40.5 mm With 5 keys With emergency and hazard function 	●	●	●	●	●	●	●	●
Glazing frame								
<ul style="list-style-type: none"> Stainless steel, bonded 			●	●	●	●	●	●
Glazing								
<ul style="list-style-type: none"> Triple-pane insulated glazing, exterior laminated safety glass – float sand-blasted with clear stripes – interior safety glass 			●	●	●	●	●	●
Frame								
<ul style="list-style-type: none"> Aluminium block frame with thermal break (colour matching the door leaf) With aluminium/plastic threshold with thermal break (can be exchanged later) 	●	●	●	●	●	●	●	●
Side element/transom light								
<ul style="list-style-type: none"> For doors opening inwards For doors opening outwards 	○	○	○	○	○	○	○	○

- Standard
○ Optional

Note:

For doors with dark surfaces, the material expansion is particularly high. Therefore, please check the location of the door in the building in your consultation meeting. This will ensure trouble-free door operation.

ThermoPlus Entrance Doors

Entrance door programme

Technical presentation of door set



THP entrance doors with aluminium frame, profile A3

Standard sizes		
Overall frame dimension Ordering size	Clear frame dimension	Structural opening
1000 x 2100	850 x 2005	1020 x 2110
1100 x 2100	950 x 2005	1120 x 2110

Special sizes		
THP Styles	Overall frame dimension	
	Width	Height
010/015/ 700/750/800/ 810/850/900	875 – 1250	1875 – 2250

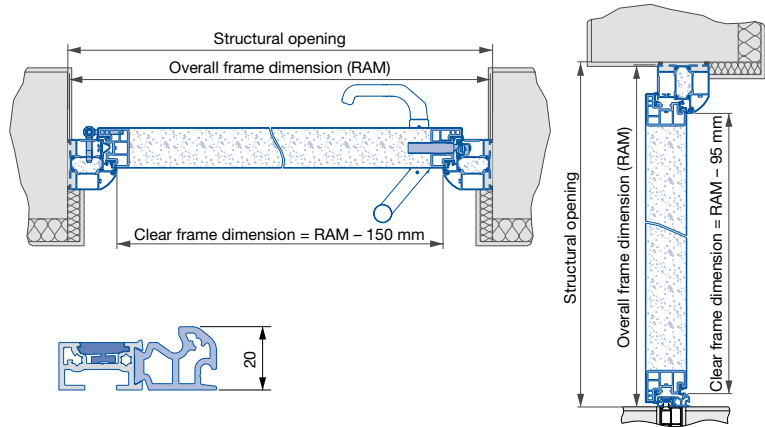

Wall connections for frames

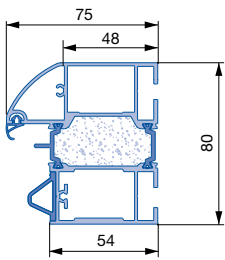

Profile A3

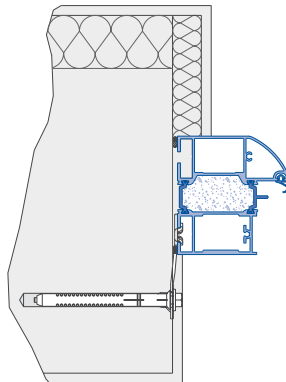

Aluminium frame
Anchor fitting

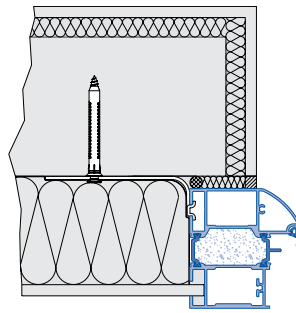

Aluminium frame
Anchor fitting

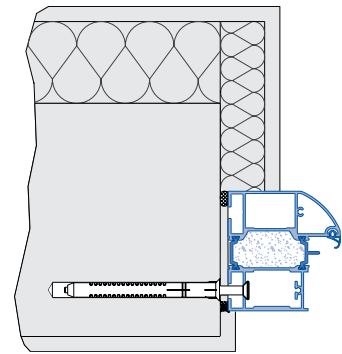

Aluminium frame
Anchor fitting
(drill holes on site)

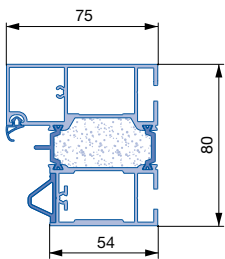

Profile A4

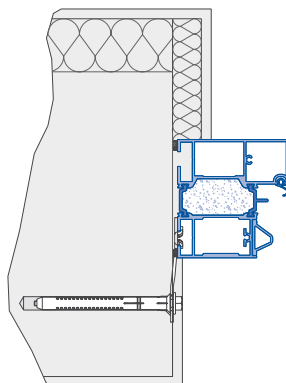

Aluminium frame
Anchor fitting

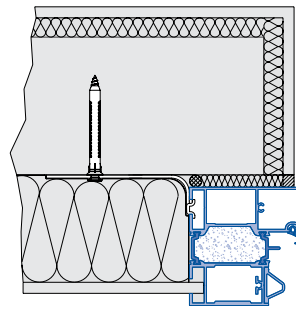

Aluminium frame
Anchor fitting

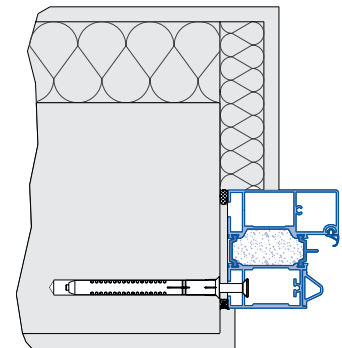

Aluminium frame
Anchor fitting
(drill holes on site)

ThermoPlus Entrance Doors

Entrance door programme

Technical presentation of door set



Wall connections for frames

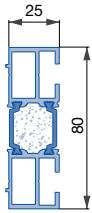

**Extension profile
25 mm**
(optional)

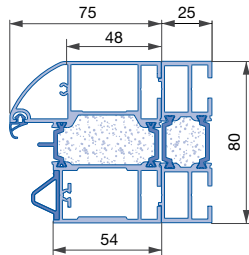

Aluminium frame A3 profile

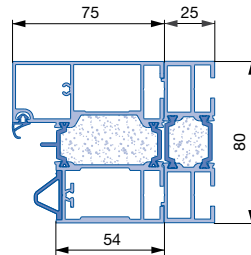

Aluminium frame A4 profile

Bottom edge

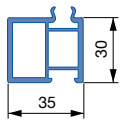

**Bottom spacer
profile**
(optional)

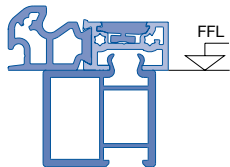

With 1 bottom spacer profile

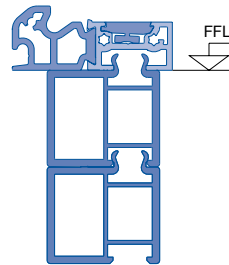

With 2 bottom spacer profiles

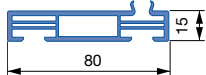

Base frame profile
(optional)

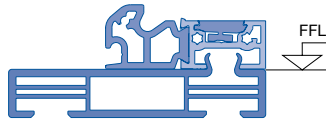

**Base frame profile
Under FFL**

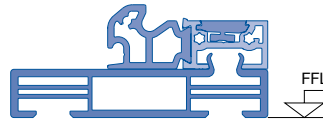

**Base frame profile
From FFL**

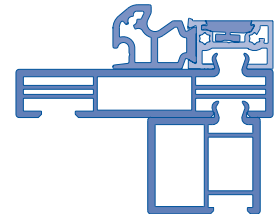

**Base frame profile
and bottom spacer profile
can be combined**

ThermoPlus Entrance Doors

Entrance door programme

Technical presentation of door set with side element/transom light



THP entrance doors with side element/transom light

Standard sizes – Side element			
THP Styles	Overall frame dimension		
	Width	Height	
010/015	400	2100	
700/750/800/810/850/900			

Special sizes – Side element			
THP Styles	Overall frame dimension		
	Width	Height	
010/015	See pages 32 and 33		
700/750/800/810/850/900			

Size range – Transom light			
THP Styles	Overall frame dimension		
	Width	Height	
All styles	See page 32		

Clear view		
	Width	Height
Side element	RAM side element – 134	RAM side element – 134
Transom light	RAM transom light – 134	RAM transom light – 134

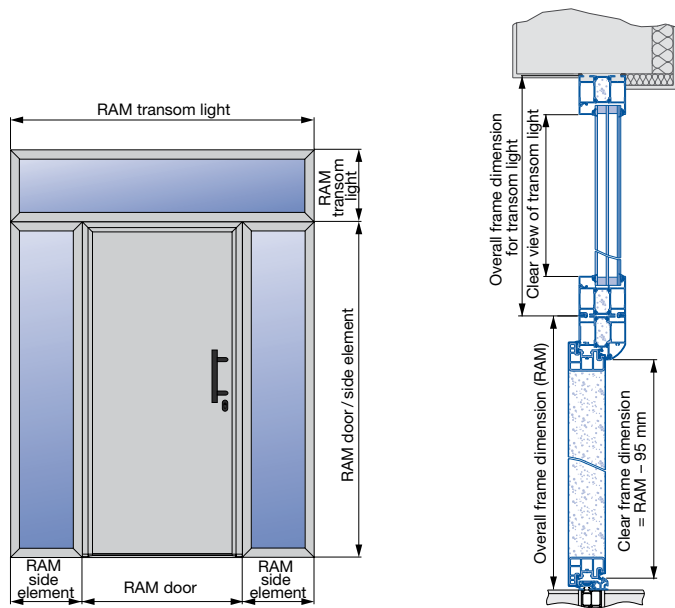
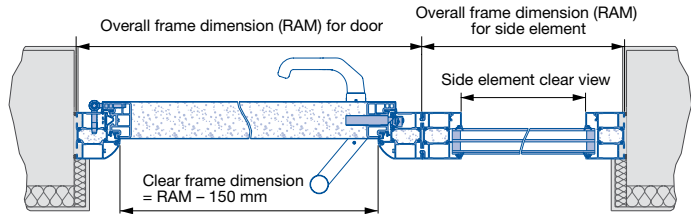
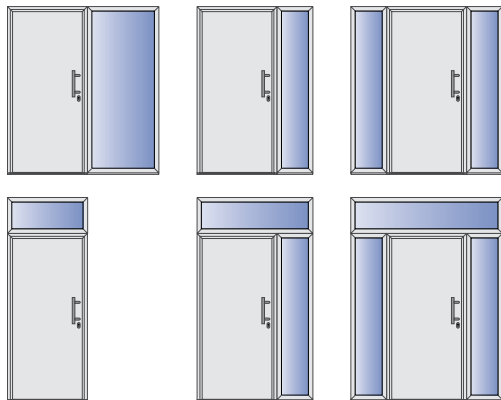

ThermoPlus Entrance Doors

Entrance door programme

Technical presentation of clear view for doors with glazing



Clear view for styles with glazing

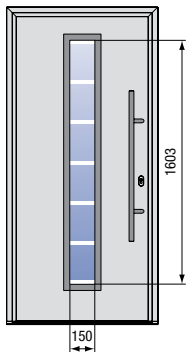

THP 700

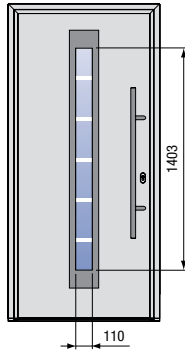

THP 750

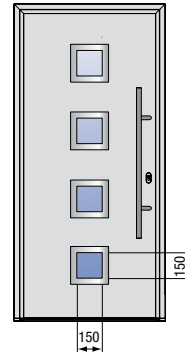

THP 800

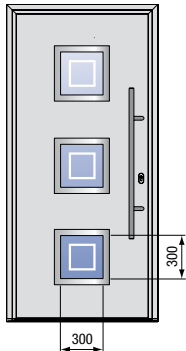

THP 810

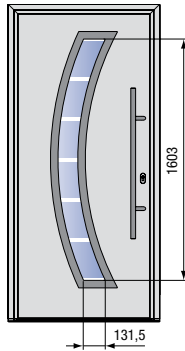

THP 850

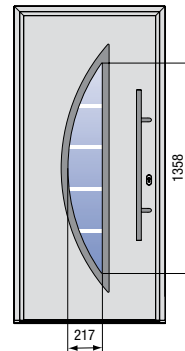

THP 900

ThermoPlus Entrance Doors

Entrance door programme



For a product description, see from page 18

- Steel door leaf overlapping the frame, with thermal break, exterior and interior in same colour
- Aluminium frame
- Multiple-point lock

Colour 15 preferred colours (see page 18)

Decor Golden Oak, Dark Oak, Night Oak, Winchester Oak and Titan Metallic CH 703

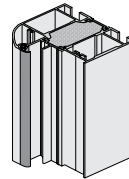

Profile A3

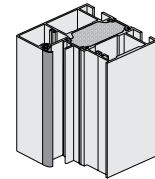

Profile A4

View	Style description	Size (RAM)	RAL 9016	Colour	Decor	RAL 9016	Colour	Decor
	Style THP 010 <ul style="list-style-type: none"> • Smooth sheet • Handle HB 14-2 	1000 × 2100	1212	1390	1424	1263	1441	1475
		1100 × 2100						
	Style THP 015 <ul style="list-style-type: none"> • Ribbed sheet • Handle HB 14-2 	From 875 × 1875	1496	1674	1708	1547	1725	1759
		Up to 1250 × 2250						
▶ U _D -value for size 1230 × 2180 mm: 0.87 W/(m ² ·K)								
	Style THP 700 <ul style="list-style-type: none"> • Smooth sheet • 3 panes of insulated glass, clear single-pane safety glass, sand-blasted float with clear horizontal stripes and clear laminated safety glass • Stainless steel glazing frame • Handle HB 38-2 	1000 × 2100	1901	2079	2114	1952	2131	2165
		1100 × 2100						
	Style THP 750 <ul style="list-style-type: none"> • Smooth sheet • 3 panes of insulated glass, clear single-pane safety glass, sand-blasted float with clear horizontal stripes and clear laminated safety glass • Stainless steel glazing frame • Handle HB 38-2 	From 875 × 1875	2186	2364	2399	2237	2416	2450
		Up to 1250 × 2250						
▶ U _D -value for size 1230 × 2180 mm: 0.98 W/(m ² ·K)								
	Style THP 800 <ul style="list-style-type: none"> • Smooth sheet • 3 panes of insulated glass, clear laminated safety glass, sand-blasted float and clear laminated safety glass • Stainless steel glazing frame • Handle HB 38-2 	1000 × 2100	2041	2220	2254	2093	2271	2305
		1100 × 2100						
	Style THP 810 <ul style="list-style-type: none"> • Smooth sheet • 3 panes of insulated glass, clear single-pane safety glass, sand-blasted float with clear squares and clear laminated safety glass • Stainless steel glazing frame • Handle HB 38-2 	From 875 × 1875	2325	2504	2538	2376	2555	2589
		Up to 1250 × 2250						
▶ U _D -value for size 1230 × 2180 mm: 0.93 W/(m ² ·K)								
	Style THP 810 <ul style="list-style-type: none"> • Smooth sheet • 3 panes of insulated glass, clear single-pane safety glass, sand-blasted float with clear squares and clear laminated safety glass • Stainless steel glazing frame • Handle HB 38-2 	1000 × 2100	2041	2220	2254	2093	2271	2305
		1100 × 2100						
	Style THP 810 <ul style="list-style-type: none"> • Smooth sheet • 3 panes of insulated glass, clear single-pane safety glass, sand-blasted float with clear squares and clear laminated safety glass • Stainless steel glazing frame • Handle HB 38-2 	From 875 × 1875	2325	2504	2538	2376	2555	2589
		Up to 1250 × 2250						
▶ U _D -value for size 1230 × 2180 mm: 0.99 W/(m ² ·K)								

ThermoPlus Entrance Doors

Entrance door programme



For a product description, see from page 18

- Steel door leaf overlapping the frame, with thermal break, exterior and interior in same colour
- Aluminium frame
- Multiple-point lock

Colour 15 preferred colours (see page 18)

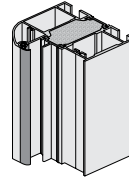

Decor Golden Oak, Dark Oak, Night Oak, Winchester Oak and Titan Metallic CH 703

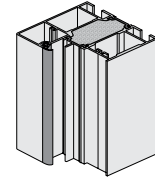

Profile A3



Profile A4

View	Style description	Size (RAM)	RAL 9016	Colour	Decor	RAL 9016	Colour	Decor
	Style THP 850 <ul style="list-style-type: none"> • Smooth sheet • 3 panes of insulated glass, clear laminated safety glass, sand-blasted float with clear horizontal stripes and clear laminated safety glass • Stainless steel glazing frame • Handle HB 38-2 	1000 × 2100	2207	2386	2420	2258	2437	2471
		1100 × 2100						
		From 875 × 1875 Up to 1250 × 2250	2492	2670	2705	2543	2722	2756
▶ U _D -value for size 1230 × 2180 mm: 0.96 W/(m ² ·K)								
	Style THP 900 <ul style="list-style-type: none"> • Smooth sheet • 3 panes of insulated glass, clear single-pane safety glass, sand-blasted float with clear horizontal stripes and clear laminated safety glass • Stainless steel glazing frame • Handle HB 38-2 	1000 × 2100	2041	2220	2254	2093	2271	2305
		1100 × 2100						
		From 875 × 1875 Up to 1250 × 2250	2325	2504	2538	2376	2555	2589
▶ U _D -value for size 1230 × 2180 mm: 0.96 W/(m ² ·K)								

ThermoPlus Entrance Doors

Entrance door programme

Accessories



Exterior door handles (included in door price)

£

Handle HB 14-2

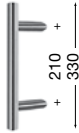

- Brushed stainless steel
- As standard for styles THP 010 and THP 015

Surcharge for conversion
of handle HB 14-2 to handle HB 38-2

102

Handle HB 38-2

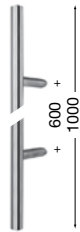

- Brushed stainless steel
- As standard for styles THP 700, THP 750, THP 800, THP 810, THP 850 and THP 900

Surcharge for conversion
of handle HB 38-2 to handle HB 14-2

102

Calculation example

£

**Conversion
THP 010 with HB 14-2
to
HB 38-2**



Style THP 010 in RAL 9016, profile A3 (standard size)	1212
+ Conversion from handle HB 14-2 to handle HB 38-2	102
= Total	1314

**Conversion
THP 700 with HB 38-2
to
Fitting ES 1**

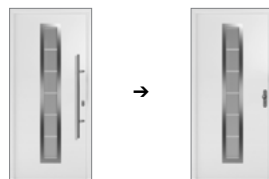

Style THP 700 in RAL 9016, profile A3 (standard size)	1901
+ Surcharge for ES 1 stainless steel knob/lever fitting	276
= Total	2177

ES 0 fittings

Including profile cylinder with 5 keys

Surcharges

£

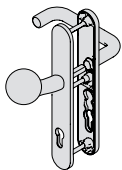

Knob / lever

Stainless steel

Each

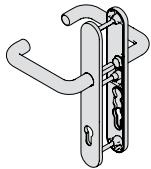
102

Lever / lever

Stainless steel

Each

102

ES 1 fittings

Including profile cylinder with 5 keys

Surcharges

£

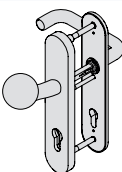

Knob / lever

Stainless steel

Each

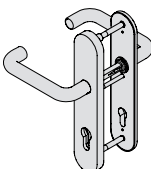
276

Lever / lever

Stainless steel

Each

276

ThermoPlus Entrance Doors

Entrance door programme

Accessories



Profile cylinder		£
	Profile cylinder (40.5 + 40.5 mm) For HB 14-2 and HB 38-2 push bars	With 8 keys Each 44 With 10 keys Each 52
	Profile cylinder (45.5 + 40.5 mm) For push bars HB 14-2 and HB 38-2 with security rose escutcheon ES 1	With 5 keys Each 66 With 8 keys Each 91 With 10 keys Each 113
	Profile cylinder (45.5 + 45.5 mm) For ES 0 fittings	With 5 keys Each 30 With 8 keys Each 44 With 10 keys Each 52
	Profile cylinder (45.5 × 45.5 mm), with drilling and pull-off protection For ES 1 fittings	With 5 keys Each 66 With 8 keys Each 91 With 10 keys Each 113
	Profile cylinder, keys to pass, with drilling and pull-off protection with security card	With 5 keys Each 87 With 8 keys Each 111 With 10 keys Each 136
	Note: No keys to pass for the profile cylinder from the fitting package	

Rose escutcheon		£
	Exterior oval rose escutcheon (screwed)	Each 38

Entrance door automation		£
	Multiple-point locking with opening via a hand transmitter <ul style="list-style-type: none"> Including 1 hand transmitter HSE 2 BS For ThermoPlus with handle HB 14-2 / HB 38-2 For ThermoPlus with lever/knob handle set ES 0 / ES 1 	Per door 808
	Multiple-point locking with opening via a radio finger-scan and hand transmitter <ul style="list-style-type: none"> Including 1 hand transmitter HSE 2 BS and 1 finger-scan FFL 12 BS For ThermoPlus with handle HB 14-2 / HB 38-2 For ThermoPlus with lever/knob handle set ES 0 / ES 1 	Per door 968
	Additional 2-button hand transmitter HSE 2 BS <ul style="list-style-type: none"> In black Textured plastic surface with plastic caps 	Each 47

ThermoPlus Entrance Doors

Entrance door programme

Accessories



Entrance door automation

£

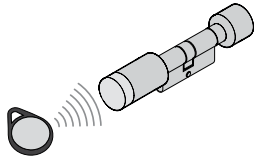

Electromechanical profile cylinder

- Including 5 transponders
- For ThermoPlus with handle HB 14-2/HB 38-2 and oval rose escutcheon

Per door **467**

Additional transponder

- For electromechanical profile cylinder

Each **21**

Profiles

£

Bottom spacer profile

	Length up to 1250 mm	Height 30 mm	Each	20
		Height 60 mm	Each	39
		Height 90 mm	Each	58
		Height 120 mm	Each	77
		Height 150 mm	Each	96
	Length up to 2250 mm	Height 30 mm	Each	34
		Height 60 mm	Each	67
		Height 90 mm	Each	100
		Height 120 mm	Each	133
		Height 150 mm	Each	166
	Length up to 3250 mm	Height 30 mm	Each	48
		Height 60 mm	Each	95
		Height 90 mm	Each	142
		Height 120 mm	Each	189
		Height 150 mm	Each	236

Base frame profile (black)

	Length up to 1250 mm	Height 15 mm	Each	20
	Length up to 2250 mm	Height 15 mm	Each	34
	Length up to 3250 mm	Height 15 mm	Each	48

Cover profile

Per package 2 × 2300 mm
and 1 × 1300 mm
Dimensions (W × D): 50 × 5 mm
Profiles sufficient for a door
without side elements

	RAL 9016	Per box	95
	Golden Oak, Dark Oak, Night Oak, Winchester Oak, Titan Metallic CH 703	Per box	127

Extension profile 25 mm

Dimensions (W × D): 25 × 80 mm

	RAL 9016	Per m	47
	Colour	Per m	55
	Golden Oak, Dark Oak, Night Oak, Winchester Oak, Titan Metallic CH 703	Per m	59

Supplementary profile

Width 20 mm, mitred,
incl. corner bracket and fitting screws



	RAL 9016	Each	195
	Colour	Each	246

ThermoPlus Entrance Doors

Entrance door programme

Accessories

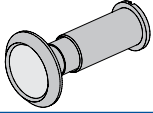
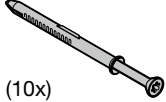
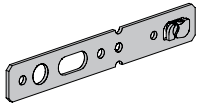
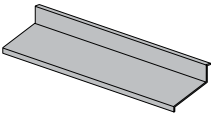
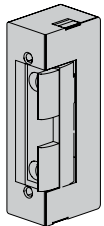
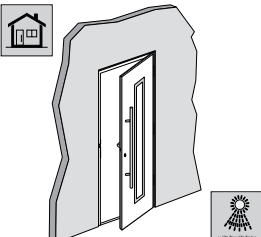

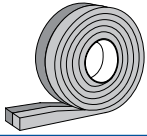
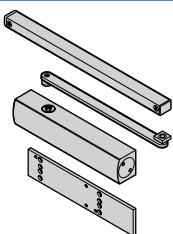
Accessories		£
	Spyhole (only for THP 010 and THP 015)	Each 46
 (10x)	Fitting set 10x screws and 10 x plugs	Per set 21
	Screw-in anchor set Length 280 mm (8 x anchors)	Per set 23
	Rain canopy Anodised aluminium	Each 21
	Electric strike with day catch (separate)	Each 64
	Door set opening outwards	Per door 61
	Stainless steel cleaner and care product (150 ml)	Each 26
	Pre-compressed sealing strip (74 mm wide) for groove widths from 6 – 15 mm 5.90 m roll (approved for RAL fitting)	Per roll 90
Door closers		Article no.
	Door leaf prepared for overhead door closer (reinforcement in door leaf)	Each 30
	Overhead door closer HDC 35 for fitting on the hinge side For ThermoPlus entrance doors with aluminium frame, profile A3 or A4	275598 Each 178
	Overhead door closer HDC 35 for fitting on the opposite hinge side For ThermoPlus entrance doors with aluminium frame, profile A4	275600 Each 178
	Mechanical hold-open device	454841 Each 69

ThermoPlus Entrance Doors











Entrance door programme

Accessories



Entrance door in RC 2 version (for a product description, see page 18) £

Attack side = opposite hinge side or hinge side

			Package HB 14-2 with security rose escutcheon	Stainless steel	Per door	217				
THP 010	THP 015		ES 1 fittings	Knob/lever	Stainless steel	276				
				Lever/lever	Stainless steel	276				
						Package HB 38-2 with security rose escutcheon and safety glass A3 (P4A)	Stainless steel	Per door	328	
THP 700	THP 750	THP 800	THP 810	THP 850	THP 900	ES 1 fittings and safety glass A3 (P4A)	Knob/lever	Stainless steel	Per door	387
							Lever/lever	Stainless steel	Per door	387
						Clear glass and safety glass A3 (P4A)		Per side element*	136	
Side element						Sand-blasted float and safety glass A3 (P4A)		Per side element*	136	
						Sand-blasted float with clear stripes and safety glass A3 (P4A)		Per side element*	659	
						Clear glass and safety glass A3 (P4A)		Per transom light **	136	
Transom light						Sand-blasted float and safety glass A3 (P4A)		Per transom light **	136	

* Only possible in the size range with a width of 400 – 550 mm (overall frame dimension).

** Only possible in the size range with a height of 400 – 500 mm (overall frame dimension).

Example for calculating an entrance door in an RC 2 version £

Conversion
THP 700 with HB 38-2
to
Package HB 38-2 with
security rose escutcheon



Style THP 700 in RAL 9016, profile A3 (standard size)	1901
+ Conversion for package HB 38-2 with security rose escutcheon	328
= Total	2229

ThermoPlus Entrance Doors

Entrance door programme

Accessories



Embellishments in stainless steel look (on the exterior)

£

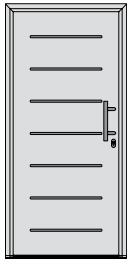

Embellishment in stainless steel look view 400

- For style 015 (inlay length 577 mm per rib)

Per door

150

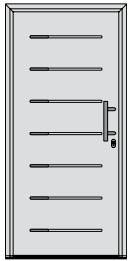

Embellishment in stainless steel look view 401

- For style 015 (inlay length 118 mm per rib)

Per door

150

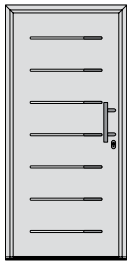

Embellishment in stainless steel look view 402

- For style 015 (inlay length 118 mm per rib)

Per door

150

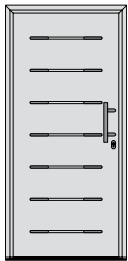

Embellishment in stainless steel look view 403

- For style 015 (inlay length 2 × 118 mm per rib)

Per door

150

Stainless steel bottom sheet (on the exterior)

£

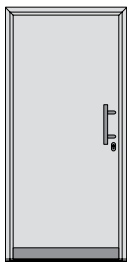

Stainless steel bottom sheet

- Bottom sheet height 110 mm
- Size range of heights for style

Style	Height (RAM)
010	1875 – 2250 mm
015 / 700 / 750 / 800 / 810 / 850 / 900	2050 – 2250 mm

Per door

141

ThermoPlus Entrance Doors

Entrance door programme

Side elements and transom lights



Side element

Fixed side element assembly

Standard size

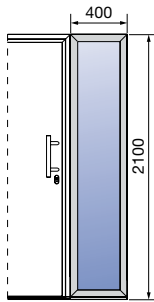

Ordering sizes RAM (mm) Width x height	Glass	RAL 9016	Colour	Decor
400 x 2100	Clear glass	765	862	895
	Sand-blasted float	765	862	895
	Sand-blasted float with clear stripes	1288	1385	1417

Side element

Fixed side element assembly

Special sizes

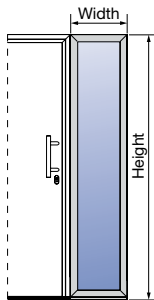

Ordering sizes RAM up to (mm) Width x height	Glass	RAL 9016	Colour	Decor
From 300 x 1875 to 500 x 2250 to 1000 x 2250 *	Clear glass or sand- blasted float according to overview on page 33	913	1010	1042
		1057	1154	1186
From 300 x 1875 to 500 x 2250 to 1000 x 2250 *	Sand-blasted float with clear stripes according to overview on page 33	1402	1533	1532
		1747	1677	1877

* Only possible without transom light
Door set with side element does not have a statics function. Statics must be ensured by the building structure.

Transom light

Fixed transom light assembly

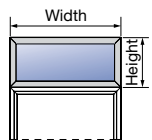

Ordering sizes RAM (mm) Width x height	Glass	RAL 9016	Colour	Decor
From 875 x 300 to 1250 x 500 to 1750 x 500 to 2250 x 500	Clear glass or sand- blasted float according to overview on page 33	615	713	746
		741	838	871
		913	1010	1042

ThermoPlus Entrance Doors

Entrance door programme

Overview of glass for side elements

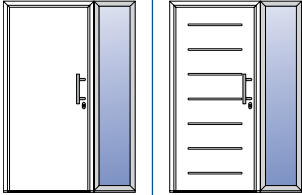
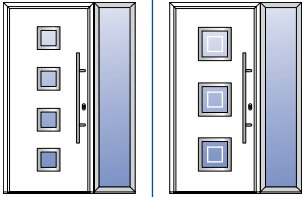
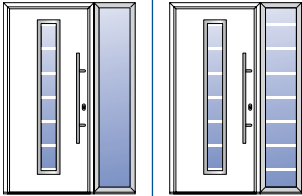
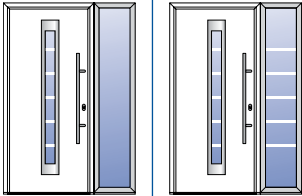
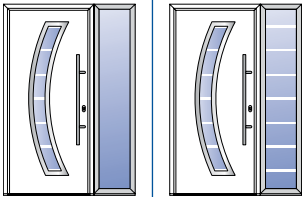
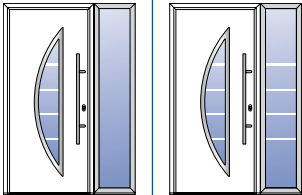
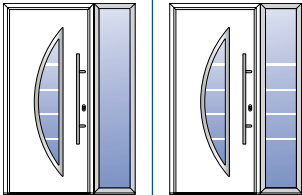

Infill/size range

Style	Glass	Size range	
		Side element	Transom light
 <p>THP 010 THP 015</p>	1. Clear laminated safety glass / sand-blasted float without clear stripes/clear laminated safety glass 2. Clear laminated safety glass / float / clear laminated safety glass	<p>Width 300 – 1000 mm</p> <p>Height 1875 – 2250 mm</p>	<p>Width 875 – 2250 mm</p> <p>Height 300 – 500 mm</p>
 <p>THP 800 THP 810</p>			
 <p>THP 700</p>	1. Clear laminated safety glass / sand-blasted float without clear stripes / clear laminated safety glass 2. Clear laminated safety glass / float / clear laminated safety glass 3. Clear laminated safety glass/sand-blasted float with clear stripes/clear laminated safety glass (only in side element)	<p>Width 300 – 1000 mm</p> <p>Height 1875 – 2250 mm</p>	<p>Width 875 – 2250 mm</p> <p>Height 300 – 500 mm</p>
 <p>THP 750</p>			
 <p>THP 850</p>			
 <p>THP 900</p>			
 <p>THP 900</p>			

Steel Security Doors RC 2

KS i Thermo with thick rebate, sheet thickness 0.6 – 0.8 mm

Standard / special sizes

RC 2





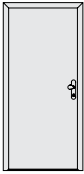
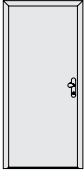



With thermal breaks!

Product description		Standard sizes		State handing	
<p>Break-in-resistant, ready-to-fit door set, single-leaf, tested according to DIN EN 1627 resistance class RC 2, for fitting to brickwork, concrete.</p> <p>Attack side = opposite hinge side</p> <p>Door leaf 46 mm thick, "Modern" smooth sheet steel, thick rebate, fully foamed, with thermal break, exterior and interior overlapping the leaf and matching colour. 4-sided, double EPDM seals, black, with continuous lip seal in the bottom sheet, additional EPDM form parts in both bottom corners for additional sealing, incl. brush seal in the frame</p> <p>Frame</p> <ul style="list-style-type: none"> Aluminium block frame with aluminium / plastic threshold With thermal break Colour matching the door leaf <p>Surface</p> <ul style="list-style-type: none"> Standard: Painted in Traffic white on both sides, based on RAL 9016, silk matt, gloss level 35 – 40 % Color: 15 preferred colours, painted on both sides, based on the RAL colour chart, silk matt, gloss level 35 – 40 % <p>Fittings</p> <ul style="list-style-type: none"> Multiple-point locking with main lock (with soft-lock latch) and 2 bolts, pivoting / hook bolt combination Stainless steel long escutcheon lever / knob handle set ES 1 3 x anti-leverage guard 5 keys Security certificate <p>Hinges</p> <ul style="list-style-type: none"> 3 two-part guide rollers (180 mm), 3-way adjustable 		 <p>Ordering sizes (overall frame dimension)</p> <p>With aluminium block frame (profile A2)</p>		<p>875 x 2000 1174</p> <p>875 x 2125 1174</p> <p>1000 x 2000 1202</p> <p>1000 x 2100 1202</p> <p>1000 x 2125 1202</p> <p>1100 x 2100 1202</p>	
		 <p>Ordering sizes (overall frame dimension)</p> <p>With aluminium block frame (profile A2)</p>		<p>From 875 x 1875 Up to 1250 x 2250 1485</p>	
		<p>Preferred colour (Color)</p> <p>Door leaf and frame in preferred colour (Color)</p>		<p>Surcharge £</p> <p>179</p>	
		<ul style="list-style-type: none"> RAL 1015 Light ivory RAL 3000 Flame red RAL 3003 Ruby red RAL 5010 Gentian blue RAL 5014 Pigeon blue 		<ul style="list-style-type: none"> RAL 6005 Moss green RAL 7016 Anthracite grey RAL 7035 Light grey RAL 7040 Window grey RAL 8003 Clay brown 	
		<p>Decor</p> <p>Door leaf and frame in decor</p>		<p>Surcharge £</p> <p>213</p>	
		<ul style="list-style-type: none"> Golden Oak Dark Oak Night Oak 		<ul style="list-style-type: none"> Winchester Oak Titan Metallic CH 703 	
		<p>Accessories</p>			
		<p>Spyhole, fitted at approx. 1550 mm from FFL</p>		<p>Each 46</p>	
		<p>Slide rail overhead door closer HDC 35</p>		<p>Each 178</p>	
		<p>Prepared for overhead door closer (reinforcement in door leaf)</p>		<p>Each 30</p>	
		<p>Lever handle / lever handle, ES 1 stainless steel</p>		<p>No surcharge</p>	
		<p>Electric strike with day catch (separate)</p>		<p>64</p>	
		<p>Bottom spacer profile</p>		<p>Height 30 mm Each 20</p> <p>Height 60 mm Each 39</p> <p>Height 90 mm Each 58</p> <p>Height 120 mm Each 77</p> <p>Height 150 mm Each 96</p>	
		<p>Pre-compressed sealing strip (56 mm wide) for groove widths from 6 – 15 mm, 5.90 m roll</p>		<p>Per roll 69</p>	

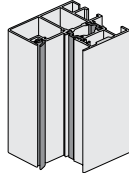
MZ Thermo Thick Rebate – Steel

Sheet thickness 0.6 – 0.8 mm

Standard / special sizes

Product description																																	
<ul style="list-style-type: none"> Steel door leaf overlapping the frame, with thermal break, exterior and interior in same colour Aluminium frame for fitting to brickwork and concrete Mortice lock (single locking) prepared for profile cylinder and 3 keys, without emergency and hazard function <p>► Ordering size = overall frame dimension (nominal size)</p>				 <p>A2 profile</p>																													
<p>Color</p> <table border="0"> <tr> <td>RAL 1015</td><td>Light ivory</td> <td>RAL 6005</td><td>Moss green</td> <td>RAL 8028</td><td>Terra brown</td> </tr> <tr> <td>RAL 3000</td><td>Flame red</td> <td>RAL 7016</td><td>Anthracite grey</td> <td>RAL 9001</td><td>Cream</td> </tr> <tr> <td>RAL 3003</td><td>Ruby red</td> <td>RAL 7035</td><td>Light grey</td> <td>RAL 9002</td><td>Grey white</td> </tr> <tr> <td>RAL 5010</td><td>Gentian blue</td> <td>RAL 7040</td><td>Window grey</td> <td>RAL 9006</td><td>White aluminium</td> </tr> <tr> <td>RAL 5014</td><td>Pigeon blue</td> <td>RAL 8003</td><td>Clay brown</td> <td>RAL 9007</td><td>Grey aluminium</td> </tr> </table>						RAL 1015	Light ivory	RAL 6005	Moss green	RAL 8028	Terra brown	RAL 3000	Flame red	RAL 7016	Anthracite grey	RAL 9001	Cream	RAL 3003	Ruby red	RAL 7035	Light grey	RAL 9002	Grey white	RAL 5010	Gentian blue	RAL 7040	Window grey	RAL 9006	White aluminium	RAL 5014	Pigeon blue	RAL 8003	Clay brown
RAL 1015	Light ivory	RAL 6005	Moss green	RAL 8028	Terra brown																												
RAL 3000	Flame red	RAL 7016	Anthracite grey	RAL 9001	Cream																												
RAL 3003	Ruby red	RAL 7035	Light grey	RAL 9002	Grey white																												
RAL 5010	Gentian blue	RAL 7040	Window grey	RAL 9006	White aluminium																												
RAL 5014	Pigeon blue	RAL 8003	Clay brown	RAL 9007	Grey aluminium																												
<p>Decor Golden Oak, Dark Oak, Night Oak, Winchester Oak and Titan Metallic CH 703</p>																																	
View	Style description	Size (RAM)	RAL 9016	Color	Decor																												
	<p>Style TPS 011</p> <ul style="list-style-type: none"> 3 two-part guide rollers (180 mm), three-way adjustable with cover caps (aluminium / stainless steel look) Lever handle set (lever / lever) made of plastic, black, rose escutcheon <p>► Handing as specified!</p>	875 × 2000	715	894	928																												
		875 × 2125																															
		1000 × 2000	742	921	955																												
		1000 × 2100																															
1000 × 2125																																	
1100 × 2100	From 875 × 1875	1034	1213	1247																													
Up to 1250 × 2250																																	
► U _D value for size 1230 × 2180 mm: 1.1 W / (m ² ·K)																																	
	<p>Style TPS 021</p> <ul style="list-style-type: none"> 3 two-part guide rollers (180 mm), three-way adjustable with cover caps (aluminium / stainless steel look) Double-pane insulated glazing, 26 mm thick, exterior laminated safety glass – interior Mastercarré single-pane safety glass Plastic glazing frame in door frame colour ¹⁾ Lever handle set (lever / lever) made of plastic, black, rose escutcheon <p>► Handing as specified!</p>	875 × 2000	1047	1437	1472																												
		875 × 2125																															
		1000 × 2000	1072	1462	1498																												
		1000 × 2100																															
1000 × 2125																																	
1100 × 2100	From 875 × 1875	1367	1757	1793																													
Up to 1250 × 2250																																	
► U _D value for size 1230 × 2180 mm: 1.4 W / (m ² ·K)																																	
	<p>Style TPS 051</p> <ul style="list-style-type: none"> 3 two-part guide rollers (180 mm), three-way adjustable with cover caps (aluminium / stainless steel look) Double-pane insulated glazing, 24 mm thick, exterior laminated safety glass – interior Mastercarré single-pane safety glass Plastic glazing frame in door frame colour ¹⁾ Lever handle set (lever / lever) made of plastic, black, rose escutcheon <p>► Handing as specified!</p>	875 × 2000	1047	1437	1472																												
		875 × 2125																															
		1000 × 2000	1072	1462	1498																												
		1000 × 2100																															
1000 × 2125																																	
1100 × 2100	From 875 × 1875	1367	1757	1793																													
Up to 1250 × 2250																																	
► U _D value for size 1230 × 2180 mm: 1.6 W / (m ² ·K)																																	
 	<p>Style TPS 081</p> <ul style="list-style-type: none"> 2 two-part guide rollers (180 mm), three-way adjustable with cover caps (aluminium / stainless steel look) Lever handle set (lever / lever) made of plastic, black, short escutcheon <p>► Dual handed! U_D value for size 1230 × 2180 mm: 1.1 W / (m²·K)</p>	875 × 2000	715	-	-																												
		875 × 2125																															
		1000 × 2000	742	-	-																												
		1000 × 2100																															
1000 × 2125																																	
1100 × 2100																																	
► No further accessories / decors / colours are possible in dual handed doors!																																	

Sizes marked with a dot (•) indicate doors in RAL 9016 that are **available from stock**.

1) For decor door surface finishes, the plastic glazing frames are coated in a colour matching the decor

MZ Thermo Thick Rebate – Steel

Sheet thickness 0.6 – 0.8 mm

Accessories

With thermal breaks

MZ

46



Door closer			
Prepared for overhead door closer (reinforcement in door leaf)			30
Slide rail overhead door closer HDC 35			178
Fittings			
			£
Lever handle set, rose escutcheon, prepared for profile cylinder	Black plastic (standard)		71
	Anodised aluminium (F1) *		177
	Brushed stainless steel *		238
Lever/knob handle set, rose escutcheon, prepared for profile cylinder	Black plastic *		119
	Anodised aluminium (F1) *		191
	Brushed stainless steel *		252
Multiple-point locking (hook bolt lock) with rose escutcheon (stainless steel lever handle/lever handle)			On request
Anti-panic fittings acc. to DIN EN 179 (opening outwards)			
			£
Single-point locking (panic lock with stainless steel cover, distance 92 mm, left-hand hinged or right-hand hinged)	With anti-panic function E		163
	With split spindle, passage function D		196
Multiple-point locking (panic lock with stainless steel cover, distance 92 mm, left-hand hinged or right-hand hinged) ▶ Possible from door height 1990 mm	With anti-panic function E		On request
	With split spindle, passage function D		On request
Lever/knob handle set, rose escutcheon, prepared for profile cylinder	Black plastic *		119
	Anodised aluminium (F1) *		191
	Brushed stainless steel *		252
Panic handle set with split spindle, rose escutcheon, prepared for profile cylinder	Black plastic *		119
	Anodised aluminium (F1) *		191
	Brushed stainless steel *		252
Profiles			
			Per m £
Extension profile 25 mm	RAL 9016		42
	Color		50
	Decor		53
Extension profile 50 mm	RAL 9016		47
	Color		55
	Decor		59
Cover profile (package is sufficient for one door set)	RAL 9016	Per box	95
	Decor	Per box	127
Accessories			
Retractable bottom seal (frame without threshold)			280
Spyhole			46
Electric strike with day catch (separate)			64
Door drip	RAL 9016		28
Rain canopy	Anodised aluminium		21
Pre-compressed sealing strip (width 56 mm) for groove widths between 6 – 15 mm, 5.9 m roll		Per roll	69
Offset lever height from 775 mm to 1275 mm from FFL			91
Bottom spacer profile	Height 30 mm	Each	20
	Height 60 mm	Each	39
	Height 90 mm	Each	58
	Height 120 mm	Each	77
	Height 150 mm	Each	96

* Replaces standard fittings

Version as a security door with thermal break in resistance class RC 2

Please see your Hörmann specialist dealer

MZ ThermoPlus Thick Rebate – Steel

Sheet thickness 0.6 – 0.8 mm

Standard / special sizes

High thermal insulation
of up to 0.87 W / (m²·K)

Product description

- Steel door leaf overlapping the frame, with thermal break, exterior and interior in same colour
 - Aluminium frame for fitting to brickwork and concrete
 - Mortice lock (single locking) prepared for profile cylinder and 3 keys, without emergency and hazard function
- Ordering size = overall frame dimension (nominal size)

Color

RAL 1015	Light ivory	RAL 6005	Moss green	RAL 8028	Terra brown
RAL 3000	Flame red	RAL 7016	Anthracite grey	RAL 9001	Cream
RAL 3003	Ruby red	RAL 7035	Light grey	RAL 9002	Grey white
RAL 5010	Gentian blue	RAL 7040	Window grey	RAL 9006	White aluminium
RAL 5014	Pigeon blue	RAL 8003	Clay brown	RAL 9007	Grey aluminium

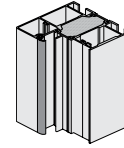

A4 profile

Decor

Golden Oak, Dark Oak, Night Oak, Winchester Oak and Titan Metallic CH 703

View	Style description	Size (RAM)	RAL 9016	Color	Decor
	Style THP 011 <ul style="list-style-type: none"> • 3 two-part guide rollers (180 mm), three-way adjustable with cover caps (aluminium / stainless steel lock) • Lever handle set (lever / lever) made of plastic, black, rose escutcheon <p>► Handing as specified!</p>	875 × 2000	1052	1231	1265
		875 × 2125			
		1000 × 2000	1078	1257	1291
		1000 × 2100			
		1000 × 2125			
1100 × 2100	1371	1550	1584		
From 875 × 1875					
Up to 1250 × 2250					

► U_D value for size 1230 × 2180 mm: 0.87 W / (m²·K)

MZ ThermoPlus Thick Rebate – Steel

Sheet thickness 0.6 – 0.8 mm

Accessories

With thermal breaks



Door closer		
Prepared for overhead door closer (reinforcement in door leaf)		30
Slide rail overhead door closer HDC 35		178
Fittings		
		£
Lever handle set, rose escutcheon, prepared for profile cylinder	Black plastic (standard)	71
	Anodised aluminium (F1) *	177
	Brushed stainless steel *	238
Lever/knob handle set, rose escutcheon, prepared for profile cylinder	Black plastic *	119
	Anodised aluminium (F1) *	191
	Brushed stainless steel *	252
Multiple-point locking (hook bolt lock) with rose escutcheon (stainless steel lever handle/lever handle)		On request
Anti-panic fittings acc. to DIN EN 179 (opening outwards)		
		£
Single-point locking (panic lock with stainless steel cover, distance 92 mm, left-hand hinged or right-hand hinged)	With anti-panic function E	163
	With split spindle, passage function D	196
Multiple-point locking (panic lock with stainless steel cover, distance 92 mm, left-hand hinged or right-hand hinged)	With anti-panic function E	On request
	With split spindle, passage function D	On request
► Possible from door height 1990 mm		
Lever/knob handle set, rose escutcheon, prepared for profile cylinder	Black plastic *	119
	Anodised aluminium (F1) *	191
	Brushed stainless steel *	252
Panic handle set with split spindle, rose escutcheon, prepared for profile cylinder	Black plastic *	119
	Anodised aluminium (F1) *	191
	Brushed stainless steel *	252
Profiles		
		Per m £
Extension profile 25 mm	RAL 9016	47
	Color	55
	Decor	59
Cover profile (package is sufficient for one door set)	RAL 9016	Per box 95
	Decor	Per box 127
Accessories		
Spyhole		46
Electric strike with day catch (separate)		64
Door drip	RAL 9016	28
Rain canopy	Anodised aluminium	21
Screw-in anchor set, length 280 mm (8 × anchors)		Per set 23
Pre-compressed sealing strip (width 74 mm) for groove widths between 6 – 15 mm, 5.9 m roll		Per roll 90
Offset lever height from 775 mm to 1275 mm from FFL		91
Bottom spacer profile	Height 30 mm	Each 20
	Height 60 mm	Each 39
	Height 90 mm	Each 58
	Height 120 mm	Each 77
	Height 150 mm	Each 96
Base frame profile	Height 15 mm	Each 20

* Replaces standard fittings

Version as a security door with thermal break in resistance class RC 2

Please see your Hörmann specialist dealer