

NEW Designer Hand-Transmitters HSE 2 BS



Series 2000 Garage Door Price List

9.9.2013



Hörmann Garage Doors



HÖRMANN IS ALWAYS COMMITTED TO EXCELLENCE: “In Engineering, in User Safety and in Design.”

All our products are third party tested to the highest standards and are certified to the high safety requirements and performance characteristics of the European Standard 13241-1.

This gives you the reassurance that your purchase of a Hörmann product is a safe investment. We are also committed to our national network of Garage Door Specialist Distributors.

These are independent businesses, who believe in customer service and have skills to advise you on the best product for your property, also providing quality fitting and finishing.

“A great product performs at its best when fitted by experts.”

Door Operating Systems

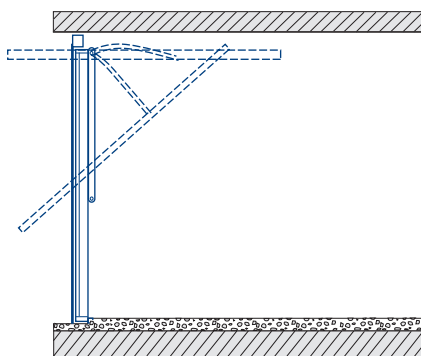

Canopy Operating Gear

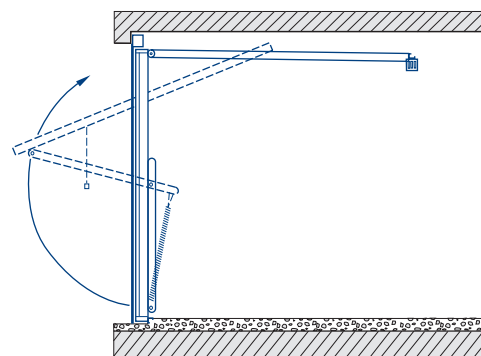

Retractable Operating Gear

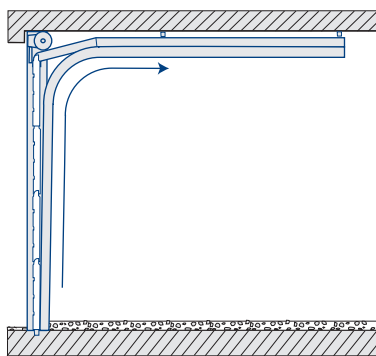



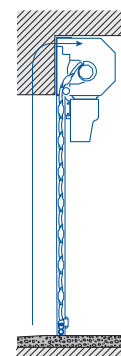





Sectional Operating Gear



RollMatic Operating Gear

We reserve the right to change specification without prior notification.





Contents

	Up-and-over garage doors	Canopy and retractable with steel infill	
		 2602 Finesse steel door style	4 - 7
		Canopy and retractable with timber infill	8 - 11
		Canopy and retractable with GRP infill (Glass reinforced polyester)	12
	Sectional garage doors	Sectional Garage Doors	
		Optional extras and window designs	13
		Sectional Garage Doors LTE 40	
		Single-skinned steel Sectional doors	14
		Sectional Garage Doors EPU 40	
		Double-skinned steel Sectional doors	15
		Sectional Garage Doors LPU 40	
		Double-skinned steel Sectional doors	
 New Silkgrain surface finish in White			
 New Silkgrain surface finish in Titan	16 - 17		
	RollMatic roller garage doors	Roller Garage Doors	
		RollMatic	18 - 19
	Garage door operators	Garage Door Operators	
		 Designer HSE2 BS hand transmitters	20 - 21

Hörmann Up-and-Over Doors

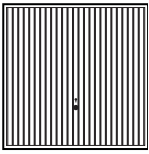
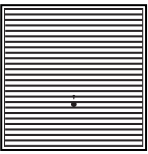
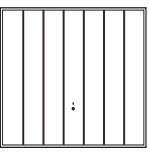
Canopy & retractable with steel infill



SINGLE DOORS													
Door sizes BR		2001 Vertical		2002 Horizontal		2601 Elegance		2602 Finesse		2101 Ilkley		2103 Caxton	
Imperial	Metric	CAN.	RET.	CAN.	RET.	CAN.	RET.	CAN.	RET.	CAN.	RET.	CAN.	RET.
6'6" x 6'6"	1981 x 1981	524	566	457	499								
7'0"	1981 x 2134	524	566	457	499								
6'10" x 6'4"	2083 x 1930	523	565	468	510								
6'6"	2083 x 1981	523	565	478	520								
7'0"	2083 x 2134	535	577	496	538								
7'0" x 6'4"	2134 x 1930	525 ¹	567 ¹	473	515					879	921		
6'6"	2134 x 1981	509 ¹	552 ¹	417 ¹	459 ¹	648	690	648	690	879	921	847	889
7'0"	2134 x 2134	530 ¹	572 ¹	479 ¹	521 ¹	685	727	685	727	888	930	854	896
7'6"	2134 x 2286		658		612								
7'3" x 6'4"	2210 x 1930	550 ¹	593 ¹	515	557								
6'6"	2210 x 1981	554	596	518	560								
7'0"	2210 x 2134	561	603	524	566								
7'5" x 6'6"	2261 x 1981	558	600	515	557					912	954	898	940
7'0"	2261 x 2134	627	670	587	630					922	964	907	949
7'6" x 6'4"	2286 x 1930	571	613	515	557					912	954		
6'6"	2286 x 1981	571 ¹	613 ¹	515 ¹	557 ¹	720	762	720	762	922	954	898	940
7'0"	2286 x 2134	627 ¹	670 ¹	588 ¹	632 ¹	831	873	831	873	922	964	907	949
7'6"	2286 x 2286		716		732								
7'8" x 6'4"	2337 x 1930	647	689	593	635								
8'0" x 6'4"	2438 x 1930	678	720	594	636					968	1010		
6'6"	2438 x 1981	678 ¹	720 ¹	594	636	854	896	854	896	968	1010	930	972
7'0"	2438 x 2134	701 ¹	743 ¹	607	649	854	896	854	896	978	1020	977	1019
7'6"	2438 x 2286		806		713								
8'0"	2438 x 2438		834		742								
8'6" x 6'6"	2590 x 1981		776		686								
7'0"	2590 x 2134		842		710								
9'0" x 6'6"	2743 x 1981		897		855								
7'0"	2743 x 2134		979		897								
10'0" x 6'6"	3048 x 1981		1086		1071								
7'0"	3048 x 2134		1086		1071								

Prices Marked ¹ - optional Terra brown RAL 8028 available. Surcharge on door, see page 7.

DOUBLE DOORS Internal frame sizes BR		2001 Vertical	2002 Horizontal	2601 Elegance	2602 Finesse	2101 Ilkley	Style Not Available
Imperial	Metric	Retractable	Retractable	Retractable	Retractable	Retractable	
11'0" x 6'6"	3353 x 1981	1180*	1180*				
7'0"	3353 x 2134	1180*	1180*				
12'0" x 6'6"	3658 x 1981	1240*	1240*				
7'0"	3658 x 2134	1250*	1250*				
13'0" x 6'6"	3962 x 1981	1350*	1350*				
7'0"	3962 x 2134	1350*	1350*				
14'0" x 6'6"	4267 x 1981	1300	1300			1800*	
7'0"	4267 x 2134	1300	1300			1800*	





Prices Marked * - Not available ex-stock, delivery 2 - 3 weeks

MATCHING SIDE DOORS Ordering sizes	2001 Vertical	2002 Horizontal	2601 Elegance	2602 Finesse	Style Not Available	Style Not Available
---------------------------------------	------------------	--------------------	------------------	-----------------	------------------------	------------------------

Prices Marked ² - Not available ex-stock, delivery 4 - 8 weeks

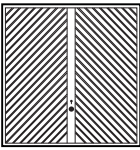
875 x 1875						
875 x 2000	353	712 ²	667 ²	667 ²		
875 x 2125						
1000 x 2000	376	737 ²	761 ²	761 ²		
1000 x 2125						



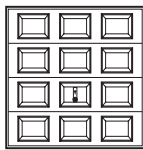

										75mm steel framed doors Recommended structural opening sizes allowing tolerance of 10mm on width & 5mm on height For steel frame options see page 7	
2003 Chevron		2004 Georgian		2304 Georgian with windows		2104 Marquess		2504 Countess		Imperial	Metric
CAN.	RET.	CAN.	RET.	CAN.	RET.	CAN.	RET.	CAN.	RET.		
		639	681							7'0" x 6'8½"	2135 x 2044
		650	692							7'0" x 7'2¾"	2135 x 2199
		647	689							7'4" x 6'6½"	2235 x 1994
		648	690							7'4" x 6'8½"	2235 x 2044
		695	737							7'4" x 7'2¾"	2235 x 2199
		648	690							7'6" x 6'6½"	2284 x 1994
544	586	648¹	690¹	892	934	648	690	648	690	7'6" x 6'8½"	2284 x 2044
581	623	685¹	727¹	930	972	685	727	685	727	7'6" x 7'2¾"	2284 x 2199
										7'6" x 7'8½"	2284 x 2350
		720	762							7'9¼" x 6'6½"	2365 x 1994
										7'9¼" x 6'8½"	2365 x 2044
										7'9¼" x 7'2¾"	2365 x 2199
		720	762							7'11" x 6'8½"	2411 x 2044
		831	873							7'11" x 7'2¾"	2411 x 2199
		720	762							8'0" x 6'6½"	2436 x 1994
607	649	720 ¹	762 ¹	964	1006	720	762	720	762	8'0" x 6'8½"	2436 x 2044
667	710	831 ¹	873 ¹	1075	1117	831	873	831	873	8'0" x 7'2¾"	2436 x 2199
										8'0" x 7'8½"	2436 x 2350
		863	906							8'2" x 6'6½"	2489 x 1994
		854	896							8'6" x 6'6½"	2589 x 1994
764	806	854	896			854	896			8'6" x 6'8½"	2589 x 2044
796	838	888	930			888	930			8'6" x 7'2¾"	2589 x 2199
										8'6" x 7'8½"	2589 x 2350
										8'6" x 8'2¾"	2589 x 2503
										9'0" x 6'8½"	2741 x 2044
										9'0" x 7'2¾"	2741 x 2199
			1130							9'6" x 6'8½"	2894 x 2044
			1151							9'6" x 7'2¾"	2894 x 2199
										10'6" x 6'8½"	3199 x 2044
										10'6" x 7'2¾"	3199 x 2199
2003 Chevron	2004 Georgian	2304 Georgian with windows	2104 Marquess	Style Not Available						Imperial	Metric
Retractable	Retractable	Retractable	Retractable								
										11'6" x 6'8½"	3504 x 2044
										11'6" x 7'2¾"	3504 x 2199
										12'6" x 6'8½"	3809 x 2044
										12'6" x 7'2¾"	3809 x 2199
										13'6" x 6'8½"	4114 x 2044
										13'6" x 7'2¾"	4114 x 2199
1707*	1400	1890*	1400*							14'6" x 6'8½"	4419 x 2044
1707*	1400	1890*	1400*							14'6" x 7'2¾"	4419 x 2199
2003 Chevron	2004 Georgian	2304 Georgian with windows	2104 Marquess	Style Not Available							
893 ²	667 ²	770 ²	667 ²								
909 ²	761 ²	864 ²	761 ²								

Hörmann Up-and-Over Doors

Canopy & retractable with steel infill

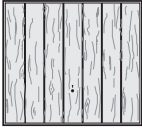
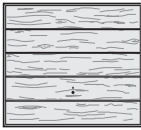
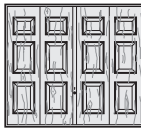

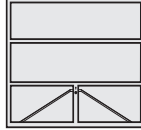
SINGLE DOORS											
Door sizes BR		Vertical Decograin Golden Oak or Rosewood		Horizontal Decograin Golden Oak or Rosewood		Georgian Decograin Golden Oak or Rosewood		Marquess Decograin Golden Oak or Rosewood		2011 Open for infill	
Imperial	Metric	CAN.	RET.	CAN.	RET.	CAN.	RET.	CAN.	RET.	CAN.	RET.
6'6" x 6'6"	1981 x 1981									441	483
	7'0" 1981 x 2134									441	483
6'10" x 6'4"	2083 x 1930									441	483
	6'6" 2083 x 1981										
	7'0" 2083 x 2134										
7'0" x 6'4"	2134 x 1930									441	483
	6'6" 2134 x 1981	658	700	567	609	777	819	777	819	441	483
	7'0" 2134 x 2134	678	720	630	672	814	856	814	856	470	513
	7'6" 2134 x 2286										
7'3" x 6'4"	2210 x 1930									492	534
	6'6" 2210 x 1981										
	7'0" 2210 x 2134										
7'5" x 6'6"	2261 x 1981	702	744	645	687	867	909	867	909	492	534
	7'0" 2261 x 2134	756	798	719	761	999	1041	999	1041	507	549
7'6" x 6'4"	2286 x 1930									492	534
	6'6" 2286 x 1981	702	744	645	687	863	906	863	906	492	534
	7'0" 2286 x 2134	756	798	719	761	999	1041	999	1041	506	548
	7'6" 2286 x 2286										
7'8" x 6'4"	2337 x 1930									515	557
8'0" x 6'4"	2438 x 1930									515	557
	6'6" 2438 x 1981	809	851	712	754	1017	1059	1017	1059	515	557
	7'0" 2438 x 2134	833	875	739	781	1052	1094	1052	1094	515	557
	7'6" 2438 x 2286										
	8'0" 2438 x 2438										
8'6" x 6'6"	2590 x 1981										
	7'0" 2590 x 2134										
9'0" x 6'6"	2743 x 1981										614
	7'0" 2743 x 2134										624
10'0" x 6'6"	3048 x 1981										1108
	7'0" 3048 x 2134										1108
DOUBLE DOORS Internal frame sizes BR		Style Not Available		Style Not Available		Style Not Available		Style Not Available		2011 Open for infill	
Imperial	Metric									Retractable	
11'0" x 6'6"	3353 x 1981										1318
	7'0" 3353 x 2134										1376
12'0" x 6'6"	3658 x 1981										1394
	7'0" 3658 x 2134										1447
13'0" x 6'6"	3962 x 1981										1464
	7'0" 3962 x 2134										1511
14'0" x 6'6"	4267 x 1981										1368
	7'0" 4267 x 2134										1368
Prices Marked * - Not available ex-stock, delivery 2 - 3 weeks											
MATCHING SIDE DOORS Ordering sizes		2001 Golden Oak or Rosewood		2002 Golden Oak or Rosewood		2004 Golden Oak or Rosewood		2104 Golden Oak or Rosewood		2011 Open for infill	
Prices Marked ² - Not available ex-stock, delivery 4 - 8 weeks											
875 x 1875											
875 x 2000		743 ²		743 ²		743 ²		743 ²		353	
875 x 2125											
1000 x 2000		848 ²		848 ²		848 ²		848 ²		376	
1000 x 2125											



The door leaf and optional box section steel frame are made of galvanised material that is polyester powder coated on both sides.

This finish is extremely durable and the standard colour is Traffic white RAL 9016.

Other colours are available listed in optional extras below.

To help maintain the aesthetic appearance of your door and prevent the build up of dirt, salt and other corrosive substances the door should be washed with a mild soap-based solution on a regular basis.

If the door is located near the coast it is important that the door panel and frame should be washed at least every 2 months.

We also suggest that all other components are brushed down on a regular basis to prevent the build up of dirt and dust etc.

The window frames on the Georgian and Ilkley doors are UPVC and white as standard.

These frames are a 2-part construction with the window material sandwiched between and frames screwed together from the back for security.

The finish of the Decograin doors is a synthetic foil-coated timber design outside (inside primer white).

The leaf frame and fixing frame is a matching powder coating.





For further choice of exciting door designs in steel, traditional or contemporary, with a vast range of sizes and increased range of colours, ask your garage door specialist about the N80 Up-and-Over garage doors available to special order.

Optional extras for Steel Doors	Price
75mm Steel fixing frame for either canopy or retractable geared single doors. Factory fitted	100
75mm Steel fixing frame for either canopy or retractable geared single doors. Factory fitted with frame to compliment Decograin	100
75mm Steel fixing frame for DOUBLE retractable geared doors, when ordered with the door	158
60mm Steel fixing frame for canopy geared doors only. Factory fitted	103
60mm Steel fixing frame for canopy geared doors only. Factory fitted with frame to compliment Decograin	103
Please note: Factory fitted 8' high frame not available	
Prices marked ¹ - optional Terra Brown RAL 8028 available. Surcharge on door	26
Retractable plus gear for retractable doors up to 7'6" wide giving extra drive through width Surcharge on retractable price	48
4 point locking kit for extra security, factory fit with door order or retrofit - single door sizes only	45
3 point locking kit for extra security, factory fit with door (this cannot be retrofitted). Available for 2001 side doors only	90
Window options for 2304 Georgian style door - Plain, crossed or diamond style with crystal glazing	Incl.
Colours are available to special order in the following styles:	
2001 Vertical, 2002 Horizontal, 2101 Ilkley available in all the listed sizes	
2004 Georgian, 2304 Georgian with windows and 2104 Marquess are available in	
7066, 7070, 7566, 7570, 7666, 7670 and 8066, 8070 sizes only	
Please note: Caxton, Chevron, Elegance, Finesse and Countess steel up-and-over doors are only available in white	
Colours:	
Terra Brown RAL 8028, Signal Blue RAL 5005, Steel Blue RAL 5011, Moss Green RAL 6005, Ruby Red RAL 3003, Jet Black RAL 9005	
Includes matching frame if ordered with door. White frame RAL 9016 also available, please specify when ordering	
Please allow 3 - 4 weeks lead time for coloured doors	
	Single doors 95
	Double doors 142
Coloured window frames for Georgian and Ilkley doors:	
Coloured window frames to match door colour	
Georgian doors (price per window, see note below for the number of windows)	26
Ilkley doors (price per single door)	126
Ilkley doors (price per double door)	252
Please state coloured windows required on order	
Orders received without reference will be supplied with white as standard	
Georgian doors up to 10' wide = 4 windows, between 10' to 13' = 6 windows, between 13' to 14' = 8 windows	
Optional handle sets	
Cast Aluminium silver colour and brass colour	106
Cast Aluminium white and brown	129
Brushed or polished stainless steel	154
Matching lever handles are also available for side doors	P.O.A.

Hörmann Up-and-Over Doors

Canopy & retractable with timber infill

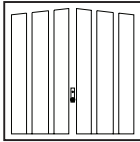

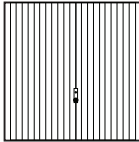
SINGLE DOORS											
Door sizes BR		2005 Measham		2007 Jacobean		2008 Tudor		2014 Rutland		2009 Vertical or Horizontal	
Imperial	Metric	CAN.	RET.	CAN.	RET.	CAN.	RET.	CAN.	RET.	CAN.	RET.
6'6" x 6'6"	1981 x 1981	902	945	1091	1133	1091	1133	1091	1133	1247	1289
7'0"	1981 x 2134	902	945	1091	1133	1091	1133	1091	1133	1247	1289
6'10" x 6'4"	2083 x 1930	902	945	1091	1133	1091	1133	1091	1133	1247	1289
6'6"	2083 x 1981										
7'0"	2083 x 2134										
7'0" x 6'4"	2134 x 1930	902	945	1091	1133	1091	1133	1091	1133	1247	1289
6'6"	2134 x 1981	902	945	1091	1133	1091	1133	1091	1133	1247	1289
7'0"	2134 x 2134	902	945	1091	1133	1091	1133	1091	1133	1247	1289
7'6"	2134 x 2286										
7'3" x 6'4"	2210 x 1930	938	980	1143	1185	1143	1185	1143	1185	1292	1334
6'6"	2210 x 1981										
7'0"	2210 x 2134										
7'5" x 6'6"	2261 x 1981	938	980	1143	1185	1143	1185	1143	1185	1292	1334
7'0"	2261 x 2134	1010	1052	1179	1221	1179	1221	1179	1221	1322	1364
7'6" x 6'4"	2286 x 1930	938	980	1143	1185	1143	1185	1143	1185	1292	1334
6'6"	2286 x 1981	938	980	1143	1185	1143	1185	1143	1185	1292	1334
7'0"	2286 x 2134	961	1003	1179	1221	1179	1221	1179	1221	1322	1364
7'6"	2286 x 2286										
8'0"	2286 x 2438										
7'8" x 6'4"	2337 x 1930	975	1017	1194	1236	1194	1236	1194	1236	1292	1334
8'0" x 6'4"	2438 x 1930	991	1033	1207	1249	1207	1249	1207	1249	1367	1409
6'6"	2438 x 1981	991	1033	1207	1249	1207	1249	1207	1249	1367	1409
7'0"	2438 x 2134	1013	1055	1238	1280	1238	1280	1238	1280	1407	1449
8'0"	2438 x 2438										
8'6" x 6'6"	2590 x 1981										
7'0"	2590 x 2134										
9'0" x 6'6"	2743 x 1981		1211		1404		1404		1404		1500
7'0"	2743 x 2134		1211		1404		1404		1404		1500
10'0" x 6'6"	3048 x 1981		1216		1501		1501		1501		1568
7'0"	3048 x 2134		1216		1501		1501		1501		1568

DOUBLE DOORS Internal frame sizes BR		2005 Measham		2007 Jacobean		2008 Tudor		2014 Rutland		2009 Vertical or Horizontal	
Imperial	Metric	CAN.	RET.	CAN.	RET.	CAN.	RET.	CAN.	RET.	CAN.	RET.
11'0" x 6'6"	3353 x 1981		2145		2366		2366		2366		2527
7'0"	3353 x 2134		2145		2366		2366		2366		2527
12'0" x 6'6"	3658 x 1981		2226		2378		2378		2378		2793
7'0"	3658 x 2134		2226		2378		2378		2378		2793
13'0" x 6'6"	3962 x 1981		2234		2566		2566		2566		3124
7'0"	3962 x 2134		2234		2566		2566		2566		3124
14'0" x 6'6"	4267 x 1981		2239		2525		2525		2525		2617
7'0"	4267 x 2134		2239		2525		2525		2525		2617



Please note: Lead times on all timber garage doors will be 3 to 4 weeks

MATCHING SIDE DOORS Ordering sizes	2005 Measham	2007 Jacobean	2008 Tudor	2014 Rutland	2009 Vertical or Horizontal
---------------------------------------	-----------------	------------------	---------------	-----------------	--------------------------------

Please note: Lead times on all timber side garage doors will be 4 to 8 weeks

875 x 1875					
875 x 2000	613	709	709	709	718
875 x 2125					
1000 x 2000	644	739	739	739	749
1000 x 2125					

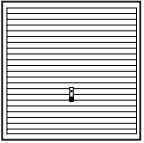

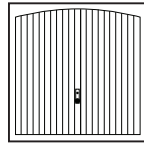
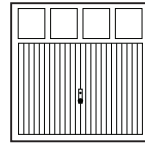

										75mm steel framed doors Recommended structural opening sizes allowing tolerance of 10mm on width & 5mm on height For steel frame options see page 11	
CAN.	RET.	CAN.	RET.	CAN.	RET.	CAN.	RET.	CAN.	RET.	Imperial	Metric
1244	1286	1445	1487	1445	1487	1445	1487	1493	1535	7'0" x 6'8½"	2135 x 2044
1244	1286	1445	1487	1445	1487	1445	1487	1493	1535	7'0" x 7'2¾"	2135 x 2199
1244	1286	1445	1487	1445	1487	1445	1487	1493	1535	7'4" x 6'6½"	2235 x 1994
										7'4" x 6'8½"	2235 x 2044
										7'4" x 7'2¾"	2235 x 2199
1244	1286	1445	1487	1445	1487	1445	1487	1493	1535	7'6" x 6'6½"	2284 x 1994
1244	1286	1445	1487	1445	1487	1445	1487	1493	1535	7'6" x 6'8½"	2284 x 2044
1244	1286	1445	1487	1445	1487	1445	1487	1493	1535	7'6" x 7'2¾"	2284 x 2199
										7'6" x 7'8½"	2284 x 2350
1292	1334	1490	1533	1490	1533	1490	1533	1559	1601	7'9¼" x 6'6½"	2365 x 1994
										7'9¼" x 6'8½"	2365 x 2044
										7'9¼" x 7'2¾"	2365 x 2199
1292	1334	1490	1533	1490	1533	1490	1533	1559	1601	7'11" x 6'8½"	2411 x 2044
1341	1383	1515	1557	1515	1557	1515	1557	1599	1641	7'11" x 7'2¾"	2411 x 2199
1292	1334	1490	1533	1490	1533	1490	1533	1559	1601	8'0" x 6'6½"	2436 x 1994
1292	1334	1490	1533	1490	1533	1490	1533	1559	1601	8'0" x 6'8½"	2436 x 2044
1341	1383	1515	1557	1515	1557	1515	1557	1631	1673	8'0" x 7'2¾"	2436 x 2199
										8'0" x 7'8½"	2436 x 2350
										8'0" x 8'2¾"	2436 x 2503
1422	1464	1635	1677	1635	1677	1635	1677	1749	1791	8'2" x 6'6½"	2489 x 1994
1422	1464	1635	1677	1635	1677	1635	1677	1749	1791	8'6" x 6'6½"	2589 x 1994
1422	1464	1635	1677	1635	1677	1635	1677	1749	1791	8'6" x 6'8½"	2589 x 2044
1422	1464	1635	1677	1635	1677	1635	1677	1749	1791	8'6" x 7'2¾"	2589 x 2199
										8'6" x 8'2¾"	2589 x 2503
										9'0" x 6'8½"	2741 x 2044
										9'0" x 7'2¾"	2741 x 2199
	1648		1880		1880		1880		1931	9'6" x 6'8½"	2894 x 2044
	1648		1880		1880		1880		1931	9'6" x 7'2¾"	2894 x 2199
	1796		2001		2001		2001		2147	10'6" x 6'8½"	3199 x 2044
	1796		2001		2001		2001		2147	10'6" x 7'2¾"	3199 x 2199
2109 Mallory		2013 Caxton		2020 Gatcombe		2114 Shepshed		2019 Garage Light		Imperial	Metric
CAN.	RET.	CAN.	RET.	CAN.	RET.	CAN.	RET.	CAN.	RET.		
	2659		2808		2808		2808		3126	11'6" x 6'8½"	3504 x 2044
	2659		2808		2808		2808		3126	11'6" x 7'2¾"	3504 x 2199
	2884		3052		3052		3052		3437	12'6" x 6'8½"	3809 x 2044
	2884		3052		3052		3052		3437	12'6" x 7'2¾"	3809 x 2199
	3129		3336		3336		3336		3871	13'6" x 6'8½"	4114 x 2044
	3129		3336		3336		3336		3871	13'6" x 7'2¾"	4114 x 2199
	3039		3245		3245		3245		3669	14'6" x 6'8½"	4419 x 2044
	3039		3245		3245		3245		3669	14'6" x 7'2¾"	4419 x 2199
2109 Mallory		2013 Caxton		2020 Gatcombe		2114 Shepshed		2019 Garage Light			
CAN.	RET.	CAN.	RET.	CAN.	RET.	CAN.	RET.	CAN.	RET.		
	809		837		854		833		953		
	842		870		889		864		984		

Hörmann Up-and-Over Doors

Canopy & retractable with timber infill

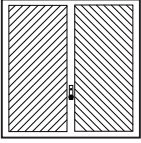
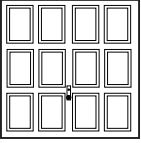

SINGLE DOORS										75mm steel framed doors Recommended structural opening sizes allowing tolerance of 10mm on width & 5mm on height For steel frame options see page 11	
Door sizes BR		2119 Leicester		2010 Chevron		2121 Chesterfield		2122 Middleton		Imperial	Metric
Imperial	Metric	CAN.	RET.	CAN.	RET.	CAN.	RET.	CAN.	RET.		
6'6" x 6'6"	1981 x 1981		1733	1543	1585		1981		1965	7'0" x 6'8½"	2135 x 2044
	7'0" 1981 x 2134		1733	1543	1585		1981		1965	7'0" x 7'2¾"	2135 x 2199
6'10" x 6'4"	2083 x 1930		1733	1543	1585		1981		1965	7'4" x 6'6½"	2235 x 1994
	6'6" 2083 x 1981									7'4" x 6'8½"	2235 x 2044
	7'0" 2083 x 2134									7'4" x 7'2¾"	2235 x 2199
7'0" x 6'4"	2134 x 1930		1747	1543	1585		1981		1965	7'6" x 6'6½"	2284 x 1994
	6'6" 2134 x 1981		1747	1543	1585		1981		1965	7'6" x 6'8½"	2284 x 2044
	7'0" 2134 x 2134		1747	1543	1585		1994		1987	7'6" x 7'2¾"	2284 x 2199
	7'6" 2134 x 2286									7'6" x 7'8½"	2284 x 2350
7'3" x 6'4"	2210 x 1930		1905	1612	1654		2127		2120	7'9¼" x 6'6½"	2365 x 1994
	6'6" 2210 x 1981									7'9¼" x 6'8½"	2365 x 2044
	7'0" 2210 x 2134									7'9¼" x 7'2¾"	2365 x 2199
7'5" x 6'6"	2261 x 1981		1913	1612	1654		2130		2120	7'11" x 6'8½"	2411 x 2044
	7'0" 2261 x 2134		1987	1656	1698		2140		2130	7'11" x 7'2¾"	2411 x 2199
7'6" x 6'4"	2286 x 1930		1911	1612	1654		2130		2120	8'0" x 6'6½"	2436 x 1994
	6'6" 2286 x 1981		1911	1612	1654		2130		2120	8'0" x 6'8½"	2436 x 2044
	7'0" 2286 x 2134		1987	1656	1698		2151		2140	8'0" x 7'2¾"	2436 x 2199
	7'6" 2286 x 2286									8'0" x 7'8½"	2436 x 2350
	8'0" 2286 x 2438									8'2" x 6'6½"	2436 x 2503
7'8" x 6'4"	2337 x 1930		2039	1762	1804					8'6" x 6'6½"	2489 x 1994
8'0" x 6'4"	2438 x 1930		2046	1762	1804					8'6" x 6'8½"	2589 x 1994
	6'6" 2438 x 1981		2046	1762	1804					8'6" x 7'2¾"	2589 x 2044
	7'0" 2438 x 2134		2091	1789	1831					8'6" x 7'8½"	2589 x 2199
	8'0" 2438 x 2438									8'6" x 8'2¾"	2589 x 2503
8'6" x 6'6"	2590 x 1981									9'0" x 6'8½"	2741 x 2044
	7'0" 2590 x 2134									9'0" x 7'2¾"	2741 x 2199
9'0" x 6'6"	2743 x 1981		2144		1950					9'6" x 6'8½"	2894 x 2044
	7'0" 2743 x 2134		2144		1950					9'6" x 7'2¾"	2894 x 2199
10'0" x 6'6"	3048 x 1981		2415		2270					10'6" x 6'8½"	3199 x 2044
	7'0" 3048 x 2134		2415		2270					10'6" x 7'2¾"	3199 x 2199
DOUBLE DOORS Internal Frame Sizes BR		2119 Leicester		2010 Chevron		Style Not Available		Style Not Available		Imperial	Metric
BR	RET.	CAN.	RET.	CAN.	RET.	CAN.	RET.	CAN.	RET.		
11'0" x 6'6"	3353 x 1981		3367		3222					11'6" x 6'8½"	3504 x 2044
	7'0" 3353 x 2134		3367		3222					11'6" x 7'2¾"	3504 x 2199
12'0" x 6'6"	3658 x 1981		3600		3282					12'6" x 6'8½"	3809 x 2044
	7'0" 3658 x 2134		3600		3282					12'6" x 7'2¾"	3809 x 2199
13'0" x 6'6"	3962 x 1981		3940		3336					13'6" x 6'8½"	4114 x 2044
	7'0" 3962 x 2134		3940		3336					13'6" x 7'2¾"	4114 x 2199
14'0" x 6'6"	4267 x 1981		3843		3245					14'6" x 6'8½"	4419 x 2044
	7'0" 4267 x 2134		3843		3245					14'6" x 7'2¾"	4419 x 2199
Please note: Lead times on all timber garage doors will be 3 to 4 weeks											
MATCHING SIDE DOORS Ordering Sizes		2119 Leicester		2010 Chevron		2121 Chesterfield		2122 Middleton			
Please note: Lead times on all timber side garage doors will be 4 to 8 weeks											
875 x 1875											
875 x 2000			731		709		709		731		
875 x 2125											
1000 x 2000			749		739		739		749		
1000 x 2125											



Our timber garage doors are constructed as an infill to fit into the Open-for-Infill Up-and-Over door frame, this gives the doors their rigid and durable construction.

The styles Measham, Jacobean, Tudor and Rutland are cedar facings glued and fixed to exterior quality plywood.

The solid cedar doors are 12mm tongue and groove boards constructed as an infill.

Cedar is organically grown with natural colour and grain variations; this is a feature of cedar.

We make every effort to harmonise the effect where possible, by hand matching the component parts used in construction.

Please note a uniform overall grain pattern cannot be guaranteed.

Protection (Basecoat)

All our timber doors are supplied with a dip immersion coat of Remmers Induline GW306 base stain primer 006 Light Oak; this coating is for temporary protection only.

If purchased in this temporary finish, please ensure that a full specification of finishing coats are applied immediately before or after installation to all exposed surfaces - inside as well as outside - with a Remmers or similar finishing coat system.

A fully finished option is available, please see options below.





For further choice of exciting door designs, traditional or contemporary in Nordic Pine and Hemlock, with a vast range of sizes, ask your garage door specialist about the N80 Up-and-Over garage doors available to special order.

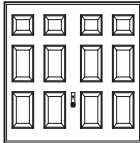

Optional extras for timber doors	Price
75mm Steel fixing frame for either canopy or retractable geared single doors, factory fitted Terra brown RAL 8028 as standard	100
75mm Steel fixing frame for DOUBLE retractable geared doors Terra brown RAL 8028 as standard when ordered with the door	158
60mm Steel fixing frame for canopy geared doors only, factory fitted Terra brown RAL 8028 as standard	103
Please note: Factory fitted 8' high frame not available	
Retractable plus gear for retractable doors up to 7'6" wide giving extra drive through width Surcharge on retractable price	48
4 point locking kit for extra security, factory fit with door order or retrofit	45
Window options for 2019 Garage Light door - Crystal or clear glazing and can be plain or with square or diamond simulated leading	Incl.
Fully finished option	
This is available as a factory process giving a 5 year erosion protection	
The product used is Remmers and is available in the following stain colours:	
Mahogany, Walnut, Dark Oak, Medium Oak, Light Oak, Teak, Ebony, Rosewood and Golden Oak	
For south facing situations exposed to strong sunlight, the dark colours are NOT recommended as they can store excessive heat and dry out	
Door sizes up to 8'0" x 7'0"	105
Door sizes up to 14'0" x 7'0"	208
Side doors	79
Optional handle sets	
Cast Aluminium silver colour and brass colour	106
Cast Aluminium white and brown	129
Brushed or polished stainless steel	154
Matching lever handles are also available for side doors	P.O.A.

Hörmann Up-and-Over Doors

Canopy & retractable with GRP infill

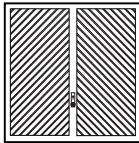

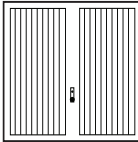
SINGLE DOORS											
Door sizes BR		2042 Windermere		2041 Coniston		2044 Stamford		2034 Penshurst		2035 Hartfield	
Imperial	Metric	CAN.	RET.	CAN.	RET.	CAN.	RET.	CAN.	RET.	CAN.	RET.
7'0" x 6'6"	2134 x 1981	1535	1579	1502	1546	1577	1621	1628	1672	1628	1672
7'0"	2134 x 2134	1535	1579	1502	1546	1577	1621	1628	1672	1628	1672
7'6" x 6'6"	2286 x 1981	1629	1672	1586	1630	1661	1705	1771	1815	1771	1815
7'0"	2286 x 2134	1629	1672	1586	1630	1661	1705	1771	1815	1771	1815
8'0" x 6'6"	2438 x 1981	1751	1795	1731	1775	1798	1842	1884	1929		
7'0"	2438 x 2134	1751	1795	1731	1775	1798	1842	1884	1929		
9'0" x 6'6"	2743 x 1981		1977*		1932*		1995*		2035		
7'0"	2743 x 2134		1977*		1932*		1995*		2035		

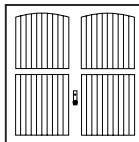
SINGLE DOORS & DOUBLE DOORS									
Door sizes BR		2040 Livingston		2047 Bourton		2048 Burford		2049 Moreton	
Imperial	Metric	CAN.	RET.	CAN.	RET.	CAN.	RET.	CAN.	RET.
7'0" x 6'6"	2134 x 1981	1800	1844	1628	1672	1628	1672	1800	1844
7'0"	2134 x 2134	1800	1844	1628	1672	1628	1672	1800	1844
7'6" x 6'6"	2286 x 1981	1944	1988	1771	1815	1771	1815	1944	1988
7'0"	2286 x 2134	1944	1988	1771	1815	1771	1815	1944	1988
8'0" x 6'6"	2438 x 1981			1885	1929	1885	1929	2057	2101
7'0"	2438 x 2134			1885	1929	1885	1929	2057	2101
14'0" x 6'6"	4267 x 1981				2994		3249		3263
7'0"	4267 x 2134				2994		3249		3263

Coniston and Stamford are supplied in white RAL 9016 OFI, all other styles are supplied in Terra brown RAL 8028 OFI.

75mm steel framed doors

Door sizes BR		Recommended structural opening sizes allowing tolerance of 10mm on width & 5mm on height	
Imperial	Metric	Imperial	Metric
7'0" x 6'6"	2134 x 1981	7'6" x 6'8½"	2284 x 2044
7'0" x 7'0"	2134 x 2134	7'6" x 7'2¾"	2284 x 2199
7'6" x 6'6"	2286 x 1981	8'0" x 6'8½"	2436 x 2044
7'6" x 7'0"	2286 x 2134	8'0" x 7'2¾"	2436 x 2199
8'0" x 6'6"	2438 x 1981	8'6" x 6'8½"	2589 x 2044
8'0" x 7'0"	2438 x 2134	8'6" x 7'2¾"	2589 x 2199
9'0" x 6'6"	2894 x 1981	9'6" x 6'8½"	2894 x 2044
9'0" x 7'0"	2743 x 2134	9'6" x 7'2¾"	2894 x 2199

For GRP colour options please consult main brochure

Window Options	Price
Clear or translucent	Per door 154
Clear or translucent with decorative leading	Per door 257

Windows are available in the Windermere and Coniston (clear or translucent) Stamford comes with black windows as standard

* Doors only available without handle (automation required)

Hörmann Sectional Doors



Optional extras and window designs

Colour surcharge		Price
Special RAL colours (please ask to see colour chart)	per m ²	51
Fittings		
Profile half cylinder 30.5 + 10mm, for garage door handle sets	each	33
Handle sets		
Handle set, black plastic, prepared for profile cylinder	each	46
Handle set, cast aluminium silver finish (F2), brass finish (F3), prepared for profile cylinder	each	121
Handle set, cast aluminium RAL 9016, brown, brushed stainless steel, prepared for profile cylinder	each	137
Handle set, polished stainless steel, prepared for profile cylinder	each	160
Emergency release		
Emergency release for sectional doors with or without handle set (Please state at point of order)	each	42
Special anchor set		
Set of 8 special anchors for between wall fitting	per set	39
ThermoFrame set		
ThermoFrame set 1	Door height up to 3000mm (length 3210 mm) Door width up to 3250mm (length 3250 mm)	per set 202
ThermoFrame set 2	Door height up to 3000mm (length 3210 mm) Door width from 3250mm up to 5500mm (length 5500 mm)	per set 240

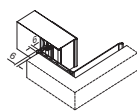
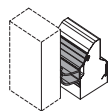
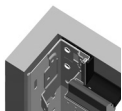

Set consists of

- **Lintel seal (1x)** with 2 lip seals
- **Plastic angle profiles (2x)** black, 84 x 22.5 mm with lip seal (frame covering may be required to match the colours)

Frame cover profiles matching the colour of the door - 55mm x 19.5mm and 90mm x 19.5mm: prices are per pair

Door heights	White		White New		Colour				Special RAL/CH 703				Decograin	
	Woodgrain		Silkgrain/Titan		Woodgrain		New Silkgrain		Woodgrain		New Silkgrain			
	55mm	90mm	55mm	90mm	55mm	90mm	55mm	90mm	55mm	90mm	55mm	90mm	55mm	90mm
2000mm	40	54	44	62	52	78	56	82	74	112	78	118	64	88
2125mm	43	58	47	66	56	83	60	88	79	119	83	126	68	94
2250mm	45	61	50	70	59	88	63	93	84	126	88	133	72	99
2375mm	48	65	53	74	62	93	67	98	88	133	93	141	76	105
2500mm	50	68	55	78	65	98	70	103	93	140	98	148	80	110

New Silkgrain white/Titan and Decograin colours are available ex-stock. **Please note colours and special RAL CH 703 must be ordered with the door.**

Renovation fascias

Set: Renovation fascias to cover damaged brickwork edges consisting of: 3 angle sections, 69/40mm, each 3000mm long

Price	126	136	163	173	177	187	143
-------	-----	-----	-----	-----	-----	-----	-----

Set: Fascia frame -95- consisting of: 2 fascias, 95mm, 2800mm long, 1 fascia 95mm, 3200mm long, fixing material

Price	144	154	181	191	195	205	160
-------	-----	-----	-----	-----	-----	-----	-----

Window designs for Sectional doors

LTE 40 with 3mm single pane in clear (FK) or crystal structure (KR), 3mm
EPU 40 or LPU 40 with 16mm double pane in clear (DS) or crystal structure (DK)

		EPU 40	LPU 40	LTE 40
S0		74	74	68
S1		90	90	81
S2		90	90	81
S10		372	372	348
S20		465	465	435
S30		558	558	
S40		651	651	
S50		744	744	
S60		744	744	
M0		88	88	
M2		102	102	
L0		118	118	

Standard Colour Surcharges for the above windows. Please note: front window frame only is painted



		Price
Standard colour or colour for Decograin	For glazing S0, S1 and S2 / M0 and M2 / L0	each 18
	For Sunrise glazing x No. of frames for width of door	each 24
RAL to choose	For glazing S0, S1 and S2 / M0 and M2 / L0	each 34
	For Sunrise glazing x No. of frames for width of door	each 44

Hörmann Sectional Doors

LTE 40 - single-skinned doors with steel sections

Single doors with Z track tension springs giving low headroom as standard

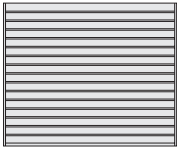

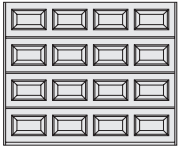
SINGLE DOORS								No. of panels	
Door sizes BR		S-ribbed Woodgrain		M-ribbed Woodgrain		S-panelled Woodgrain			
Imperial	Metric	Outside White	Outside Colour	Outside White	Outside Colour	Outside White	Outside Colour		
6'10" x 6'2"	2080 x 1875	639	784	639	784	716	861	4	
	6'10" x 6'10"	2080 x 2080	668	829	668	829	741	902	4
7'0" x 6'6"	2134 x 2000	651	809	651	809	728	886	4	
	7'0" x 6'6"	2134 x 2125	668	836	668	836	741	909	4
7'6" x 6'6"	2286 x 2000	651	821	651	821	728	898	4	
	7'0" x 6'6"	2286 x 2125	668	848	668	848	741	921	4
	7'4" x 6'6"	2286 x 2250	705	896	705	896	774	965	4
	7'9" x 6'6"	2286 x 2375	812	1013	812	1013	890	1091	4
	8'2" x 6'6"	2286 x 2500	812	1024	812	1024	889	1101	4
8'0" x 6'6"	2438 x 2000	677	858	677	858	755	936	4	
	7'0" x 6'6"	2438 x 2125	701	893	701	893	767	959	4
	7'4" x 6'6"	2438 x 2250	739	942	739	942	804	1007	4
	7'9" x 6'6"	2438 x 2375	845	1060	845	1060	915	1130	4
	8'2" x 6'6"	2438 x 2500	845	1071	845	1071	915	1141	4
8'6" x 6'6"	2591 x 2000	677	869	677	869	755	947	4	
	7'0" x 6'6"	2591 x 2125	701	905	701	905	767	971	4
9'0" x 6'6"	2740 x 2000	762	965	762	965	874	1077	4	
	7'0" x 6'6"	2740 x 2125	785	1001	785	1001	890	1106	4
9'6" x 6'6"	2896 x 2000	787	1002	787	1002	918	1133	5	
	7'0" x 6'6"	2896 x 2125	817	1045	817	1045	932	1160	5
10'0" x 6'6"	3048 x 2000	787	1013	787	1013	918	1144	5	
	7'0" x 6'6"	3048 x 2125	817	1057	817	1057	932	1172	5

For information on outside colour, see page 17

Double doors with N track torsion springs (for low headroom see bottom of page 17)

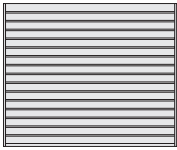
DOUBLE DOORS						
Door sizes BR		S-ribbed Woodgrain				
Imperial	Metric	Outside White	Outside Colour			
11'0" x 6'6"	3353 x 2000	1097	1346			
	7'0" x 6'6"	3353 x 2125	1138	1402		
12'0" x 6'6"	3658 x 2000	1213	1484			
	7'0" x 6'6"	3658 x 2125	1264	1552		
13'0" x 6'6"	3962 x 2000	1239	1533			
	7'0" x 6'6"	3962 x 2125	1289	1601		
14'0" x 6'6"	4267 x 2000	1344	1660			
	7'0" x 6'6"	4267 x 2125	1413	1749		
14'6" x 6'6"	4420 x 2000	1373	1701			
	7'0" x 6'6"	4420 x 2125	1446	1794		
15'0" x 6'6"	4572 x 2000	1380	1719			
	7'0" x 6'6"	4572 x 2125	1451	1811		
15'6" x 6'6"	4725 x 2000	1421	1771			
	7'0" x 6'6"	4725 x 2125	1494	1866		
16'0" x 6'6"	4877 x 2000	1420	1781			
	7'0" x 6'6"	4877 x 2125	1494	1878		

Hörmann Sectional Doors

EPU 40 - double-skinned doors with steel sections - 42-20mm

Single doors with Z track tension springs giving low headroom as standard

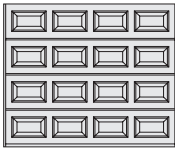

SINGLE DOORS						No. of panels
Door sizes BR		M-ribbed Woodgrain		S-panelled Woodgrain		
Imperial	Metric	Outside White	Outside Colour	Outside White	Outside Colour	
6'10" x 6'2"	2080 x 1875	736	881	869	1014	4
6'6"	2080 x 2000	767	922	908	1063	4
6'10"	2080 x 2080	796	957	919	1080	4
7'0" x 6'6"	2134 x 2000	793	951	940	1098	4
7'0"	2134 x 2125	821	989	952	1120	4
7'6" x 6'6"	2286 x 2000	793	963	940	1110	4
7'0"	2286 x 2125	821	1001	952	1132	4
7'4"	2286 x 2250	863	1054	989	1180	4
7'9"	2286 x 2375	928	1129	1052	1253	4
8'2"	2286 x 2500	928	1140	1052	1264	4
8'0" x 6'6"	2438 x 2000	834	1015	989	1170	4
7'0"	2438 x 2125	865	1057	1004	1196	4
7'4"	2438 x 2250	905	1108	1041	1244	4
7'9"	2438 x 2375	971	1186	1105	1320	4
8'2"	2438 x 2500	970	1196	1105	1331	4
8'6" x 6'6"	2591 x 2000	834	1026	989	1181	4
7'0"	2591 x 2125	865	1069	1004	1208	4
9'0" x 6'6"	2740 x 2000	901	1104	1072	1275	4
7'0"	2740 x 2125	932	1148	1089	1305	4
9'6" x 6'6"	2896 x 2000	942	1157	1124	1339	5
7'0"	2896 x 2125	977	1205	1146	1374	5
10'0" x 6'6"	3048 x 2000	942	1168	1124	1350	5
7'0"	3048 x 2125	977	1217	1146	1386	5

For information on outside colour, see page 17

Double doors with N track torsion springs (for low headroom see bottom of page 17)

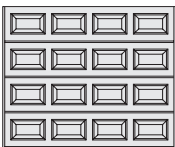
DOUBLE DOORS						No. of panels
Door sizes BR		M-ribbed Woodgrain		S-panelled Woodgrain		
Imperial	Metric	Outside White	Outside Colour	Outside White	Outside Colour	
11'0" x 6'6"	3353 x 2000	1113	1362	1336	1585	5
7'0"	3353 x 2125	1154	1418	1360	1624	5
12'0" x 6'6"	3658 x 2000	1305	1576	1571	1842	6
7'0"	3658 x 2125	1354	1642	1598	1886	6
13'0" x 6'6"	3962 x 2000	1352	1646	1634	1928	6
7'0"	3962 x 2125	1402	1714	1657	1969	6
14'0" x 6'6"	4267 x 2000	1402	1718	1697	2013	7
7'0"	4267 x 2125	1457	1793	1724	2060	7
14'6" x 6'6"	4420 x 2000	1448	1776	1758	2086	7
7'0"	4420 x 2125	1507	1855	1787	2135	7
15'0" x 6'6"	4572 x 2000	1474	1813	1790	2129	7
7'0"	4572 x 2125	1531	1891	1820	2180	7
15'6" x 6'6"	4725 x 2000	1540	1890	1877	2227	7
7'0"	4725 x 2125	1598	1970	1906	2278	7
16'0" x 6'6"	4877 x 2000	1540	1901	1877	2238	7
7'0"	4877 x 2125	1598	1982	1906	2290	7

All prices are in £ and are exclusive of VAT



15

Hörmann Sectional Doors

LPU 40 - double-skinned doors with steel sections - 42mm

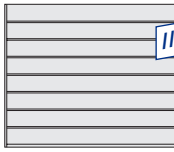

Single doors with Z track tension springs giving low headroom as standard

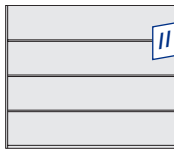

SINGLE DOORS		 S-ribbed Woodgrain/ M-ribbed Woodgrain		 // NEW M-Ribbed New Silkgrain/Micrograin		 // NEW M-ribbed New Silkgrain Titan		 // NEW L-ribbed New Silkgrain/Micrograin	
				Outside White	Outside Colour	Outside White	Outside Colour	Outside White	Outside Colour
Door sizes BR									
Imperial	Metric	Outside White	Outside Colour	Outside White	Outside Colour	Outside White	Outside Colour	Outside White	Outside Colour
6'10" x 6'2"	2080 x 1875	858	1003	903	1048	903		1010	1155
	6'6"	2080 x 2000	881	1036	944	1099	944	1035	1190
	6'10"	2080 x 2080	914	1075	980	1141	980	1048	1209
7'0" x 6'6"	2134 x 2000	881	1039	944	1102	944		1035	1193
	7'0"	2134 x 2125	914	1082	980	1148	980	1048	1216
7'6" x 6'6"	2286 x 2000	881	1051	944	1114	944		1035	1205
	7'0"	2286 x 2125	914	1094	980	1160	980	1048	1228
	7'4"	2286 x 2250	958	1149	1029	1220	1029	1096	1287
	7'9"	2286 x 2375	997	1198	1071	1272	1071	1099	1300
8'0" x 6'6"	2438 x 2000	930	1111	998	1179	998		1093	1274
	7'0"	2438 x 2125	968	1160	1041	1233	1041	1113	1305
	7'4"	2438 x 2250	1001	1204	1075	1278	1075	1170	1373
	7'9"	2438 x 2375	1045	1260	1122	1337	1122	1198	1413
8'6" x 6'6"	2591 x 2000	930	1122	998	1190	998		1093	1285
	7'0"	2591 x 2125	968	1172	1041	1245	1041	1113	1317
9'0" x 6'6"	2740 x 2000	1016	1219	1093	1296	1093		1200	1403
	7'0"	2740 x 2125	1056	1272	1135	1351	1135	1216	1432
9'6" x 6'6"	2896 x 2000	1068	1283	1149	1364	1149		1263	1478
	7'0"	2896 x 2125	1108	1336	1195	1423	1195	1283	1511
10'0" x 6'6"	3048 x 2000	1068	1294	1149	1375	1149		1263	1489
	7'0"	3048 x 2125	1108	1348	1195	1435	1195	1283	1523

For information on outside colour, see page 17

Double doors with N track torsion springs (for low headroom see bottom of page 17)

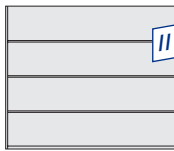
DOUBLE DOORS		 S-ribbed Woodgrain/ M-ribbed Woodgrain		 // NEW M-Ribbed New Silkgrain/Micrograin		 // NEW M-ribbed New Silkgrain Titan		 // NEW L-ribbed New Silkgrain/Micrograin	
				Outside White	Outside Colour	Outside White	Outside Colour	Outside White	Outside Colour
Door sizes BR									
Imperial	Metric	Outside White	Outside Colour	Outside White	Outside Colour	Outside White	Outside Colour	Outside White	Outside Colour
11'0" x 6'6"	3353 x 2000	1267	1516	1370	1619	1370		1498	1747
	7'0"	3353 x 2125	1317	1581	1330	1594	1330	1521	1785
12'0" x 6'6"	3658 x 2000	1425	1696	1544	1815	1544		1690	1961
	7'0"	3658 x 2125	1481	1769	1605	1893	1605	1720	2008
13'0" x 6'6"	3962 x 2000	1468	1762	1590	1884	1590		1743	2037
	7'0"	3962 x 2125	1522	1834	1649	1961	1649	1768	2080
14'0" x 6'6"	4267 x 2000	1510	1826	1637	1953	1637		1796	2112
	7'0"	4267 x 2125	1569	1905	1702	2038	1702	1825	2161
14'6" x 6'6"	4420 x 2000	1547	1875	1678	2006	1678		1845	2173
	7'0"	4420 x 2125	1610	1958	1746	2094	1746	1874	2222
15'0" x 6'6"	4572 x 2000	1559	1898	1692	2031	1692		1865	2204
	7'0"	4572 x 2125	1623	1983	1762	2122	1762	1895	2255
15'6" x 6'6"	4725 x 2000	1588	1938	1723	2073	1723		1899	2249
	7'0"	4725 x 2125	1652	2024	1791	2163	1791	1931	2303
16'0" x 6'6"	4877 x 2000	1616	1977	1754	2115	1754		1932	2293
	7'0"	4877 x 2125	1679	2063	1822	2206	1822	1966	2350

Hörmann Sectional Doors

LPU 40 - double-skinned doors with steel sections - 42mm

Single doors with Z track tension springs giving low headroom as standard

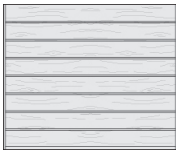
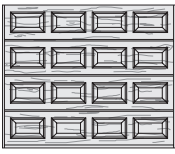
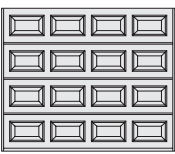

SINGLE DOORS		 L-ribbed New Silkgrain Titan	 M-ribbed Decograin Rosewood, Golden Oak, Dark Oak, Light Oak, Night Oak	 S-panelled Decograin Rosewood, Golden Oak, Dark Oak, Light Oak, Night Oak	 S-panelled Woodgrain				
Door sizes BR						No. of panels	Outside White	Outside Colour	No. of panels
Imperial	Metric								
6'10" x 6'2"	2080 x 1875	1010	986	1235	4	1078	1223	4	
6'6"	2080 x 2000	1035	1066	1260	4	1089	1244	4	
6'10"	2080 x 2080	1048	1111		4	1105	1266	4	
7'0" x 6'6"	2134 x 2000	1035	1066	1260	4	1089	1247	4	
7'0"	2134 x 2125	1048	1111	1274	4	1105	1273	4	
7'6" x 6'6"	2286 x 2000	1035	1066	1260	4	1089	1259	4	
7'0"	2286 x 2125	1048	1111	1274	4	1105	1285	4	
7'4"	2286 x 2250	1096	1168	1392	4	1183	1374	4	
7'9"	2286 x 2375	1099	1220	1422	4	1207	1408	4	
8'2"	2286 x 2500	1128	1238	1473	4	1252	1464	4	
8'0" x 6'6"	2438 x 2000	1093	1143	1337	4	1156	1337	4	
7'0"	2438 x 2125	1113	1191	1355	4	1172	1364	4	
7'4"	2438 x 2250	1170	1237	1530	4	1295	1498	4	
7'9"	2438 x 2375	1198	1295	1550	4	1315	1530	4	
8'2"	2438 x 2500	1233	1353	1579	4	1340	1566	4	
8'6" x 6'6"	2591 x 2000	1093	1110	1337	4	1156	1348	4	
7'0"	2591 x 2125	1113	1191	1355	4	1172	1376	4	
9'0" x 6'6"	2740 x 2000	1200	1193	1465	4	1263	1466	4	
7'0"	2740 x 2125	1216	1281	1490	4	1282	1498	4	
9'6" x 6'6"	2896 x 2000	1263	1266	1546	5	1331	1546	5	
7'0"	2896 x 2125	1283	1361	1573	5	1354	1582	5	
10'0" x 6'6"	3048 x 2000	1263	1305	1546	5	1307	1533	5	
7'0"	3048 x 2125	1283	1361	1573	5	1330	1570	5	

For information on outside colour, see below

All coloured doors are special order only - 4 to 8 weeks delivery. Please note: the prices listed as Outside Colour are for the following RAL colours only: RAL 1015, 3003, 5011, 5014, 6005, 6009, 7016, 7030, 7035, 7040, 8001, 8003, 8028, 9006 and 9007. Special RAL colours are available, please ask your garage door specialist.

Double doors with N track torsion springs (for low headroom see bottom of page)

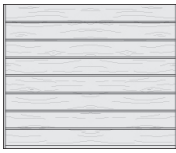
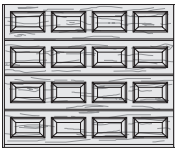
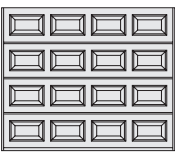
DOUBLE DOORS		 L-ribbed New Silkgrain Titan	 M-ribbed Decograin Rosewood, Golden Oak, Dark Oak, Light Oak, Night Oak	 S-panelled Decograin Rosewood, Golden Oak, Dark Oak, Light Oak, Night Oak	 S-panelled Woodgrain				
Door sizes BR						No. of panels	Outside White	Outside Colour	No. of panels
Imperial	Metric								
11'0" x 6'6"	3353 x 2000	1498	1470	1838	5	1543	1792	5	
7'0"	3353 x 2125	1521	1582	1869	5	1569	1833	5	
12'0" x 6'6"	3658 x 2000	1690	1751	2079	6	1740	2011	6	
7'0"	3658 x 2125	1720	1826	2113	6	1769	2057	6	
13'0" x 6'6"	3962 x 2000	1743	1775	2145	6	1795	2089	6	
7'0"	3962 x 2125	1768	1851	2176	6	1819	2131	6	
14'0" x 6'6"	4267 x 2000	1796	1919	2211	7	1847	2163	7	
7'0"	4267 x 2125	1825	2006	2246	7	1877	2213	7	
14'6" x 6'6"	4420 x 2000	1845	1920	2270	7	1897	2225	7	
7'0"	4420 x 2125	1874	2075	2308	7	1928	2276	7	
15'0" x 6'6"	4572 x 2000	1865	2029	2298	7	1918	2257	7	
7'0"	4572 x 2125	1895	2120	2331	7	1948	2308	7	
15'6" x 6'6"	4725 x 2000	1899	2079	2342	7	2025	2375	7	
7'0"	4725 x 2125	1931	2171	2378	7	2059	2431	7	
16'0" x 6'6"	4877 x 2000	1932	2130	2386	7	1988	2349	7	
7'0"	4877 x 2125	1966	2222	2423	7	2022	2406	7	

Low headroom

Door with track application L, torsion spring at the back

Price

105

All prices are in £ and are exclusive of VAT

17

RollMatic Roller Garage Door

Size range and prices Including operator



Doors are only available in priced size range listed! (Min. Production dimension 1000 x 1600mm) Note: Door size not over guide width

 <p>Exterior White or Colour (same price)</p>	Clear height (LH) = ordering size	3100					1493	1624	1666	1720	1762	2026	2098	2187	2232							
		3000					1493	1624	1666	1720	1762	2026	2098	2187	2232							
		2875					1493	1624	1666	1720	1762	2026	2098	2187	2232							
		2750					1472	1555	1606	1668	1731	1967	2052	2126	2200							
		2675	1354	1354	1405	1405	1472	1555	1606	1668	1731	1967	2052	2126	2200							
		2625	1354	1354	1405	1405	1472	1555	1606	1668	1731	1967	2052	2126	2200							
		2500	1354	1354	1405	1405	1424	1509	1560	1619	1666	1775	1973	2012	2094	2181	2230	2279	2325			
		2375	1267	1267	1291	1291	1376	1484	1521	1555	1613	1716	1900	1975	1995	2108	2155	2204	2251			
		2250	1267	1267	1291	1291	1376	1484	1521	1555	1613	1716	1900	1975	1995	2108	2155	2204	2251			
		2125	1267	1267	1291	1291	1353	1439	1464	1506	1548	1631	1686	1909	1929	2049	2097	2145	2193			
		2000	1267	1267	1291	1291	1304	1377	1425	1475	1496	1573	1624	1829	1875	1962	2008	2056	2105			
		1800	1267	1267	1291	1291	1304	1377	1425	1475	1496	1573	1624	1829	1875	1962	2008	2056	2105			
		1600	1267	1267	1291	1291	1304	1377	1425	1475	1496	1573	1624	1829	1875	1962	2008	2056	2105			
	1000	1250	1500	1750	1900	2000	2250	2500	2750	3000	3250	3500	3750	4000	4250	4500	4750	5000				
	Clear width (LB) = ordering size																					

Manually operated version of the RollMatic roller garage door (not possible with external roller garage doors)	Price reduction	154
External roller garage door	Surcharge	52

Doors are only available in the priced size range listed! (Min. Production dimension 1000 x 1600mm) Note: Door size not over guide width





 <p>Exterior Decograin Golden Oak or Rosewood</p>	Clear height (LH) = ordering size	3100					1950	2133	2217	2315	2399	2728	2846	2981	3069							
		3000					1940	2122	2205	2301	2384	2712	2828	2963	3049							
		2875					1929	2108	2190	2284	2366	2692	2806	2940	3025							
		2750					1893	2019	2108	2210	2313	2607	2735	2849	2964							
		2675	1658	1690	1779	1799	1886	2011	2099	2201	2302	2595	2722	2836	2951							
		2625	1654	1687	1775	1794	1881	2005	2093	2193	2295	2587	2714	2827	2941							
		2500	1647	1677	1765	1783	1815	1940	2027	2122	2205	2356	2605	2679	2799	2926	3010	3095	3176			
		2375	1544	1572	1628	1645	1751	1899	1969	2035	2128	2271	2503	2615	2666	2819	2900	2983	3064			
		2250	1535	1563	1618	1634	1739	1884	1954	2019	2110	2251	2481	2591	2641	2794	2872	2954	3033			
		2125	1528	1554	1606	1622	1701	1822	1875	1947	2020	2137	2224	2496	2544	2702	2781	2860	2939			
		2000	1520	1544	1596	1611	1634	1740	1816	1897	1944	2053	2134	2385	2460	2580	2655	2733	2811			
		1800	1507	1530	1578	1592	1615	1717	1792	1870	1915	2022	2100	2348	2420	2538	2611	2687	2762			
		1600	1507	1530	1578	1592	1615	1717	1792	1870	1915	2022	2100	2348	2420	2538	2611	2687	2762			
	1000	1250	1500	1750	1900	2000	2250	2500	2750	3000	3250	3500	3750	4000	4250	4500	4750	5000				
	Clear width (LB) = ordering size																					

Manually operated version of the RollMatic roller garage door (not possible with external roller garage doors)	Price reduction	154
External roller garage door not available with a Decograin surface!		

Optional Extras

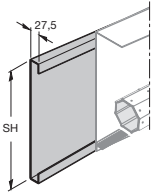
For RollMatic roller garage door including operator

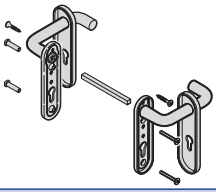
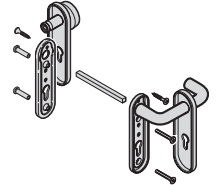

Fitting compensation set (to accommodate for unevenness on the building structure, recommended when fitting behind/in front of the opening)		Article no.	£	
Fitting compensation set LH ≤ 2300		8991235	Per set 33	
Fitting compensation set LH > 2300		8991236	Per set 39	
Chamfered bottom profile				
RollMatic roller garage door with chamfered bottom profile (not available in the surfaces Golden Oak and Rosewood)		In black	Per m 176	
		in door colour	Per m 176	
Additional fascia panel for fitting in the opening				
Reinforcement of the fascia panel State height (SD) and width!		In door colour	Per m 43	
 <p>For fitting in the opening, indicate the height (SH) 290 mm or 335 mm and total width = ordering size (clear width) +200 mm</p> <p>Note: State on door order, subsequent fitting is not possible.</p>				
Optional extras for internal roller garage doors only				
 <p>Glazing element With clear synthetic pane, window cut-out 112 x 33 mm, black glazing frame on exterior, transparent on interior (maximum 10 sections per door, number of glazing elements depending on the door width) For side doors this is not possible in the bottom section and the lock area</p>		Per m	20	
 <p>Ventilation grille Black plastic Ventilation cross section: approx. 13 cm²/grille (maximum of 10 sections per door, number of ventilation grilles dependent on the door width) For side doors this is not possible in the bottom section and the lock area</p>		Per m	20	
Without barrel casing	(only possible from a clear height (LH) of 2500mm)	Price reduction	Per m 13	
Accessories for RollMatic operators		Article no.	£	
Motor connection line, 10 m		436523	29	
Acoustic anti-lift kit		436524	Each 47	
Emergency battery HNA 18		436298	Each 123	
Emergency release				
Exterior emergency release for internal roller garage door		436526	Each 76	
Exterior emergency release for external roller garage door		Exterior emergency release	436526	
		Accessory bag for double secured release	437728	
		Bowden cable, length 1 m, for double secured release SE	4546389	
		Each	6	
		Each	9	
Note: All 3 articles are required for the external roller garage door!				
Matching side door and accessories				
 <p>Style 996</p>	Ordering sizes Nominal size Width x Height	Style 996 White or Colour	Style 996 Decograin Golden Oak or Rosewood	
	Size Range			
	From 675 x 1750		655	837
	Up to 1000 x 2000		702	918
	Up to 1250 x 2375			
Lever handle sets for side doors				
	Standard: black plastic, prepared for profile cylinder	Each	1324002	37
	Silver finish (F2) cast aluminium, prepared for profile cylinder	Each	1386100	131
	Cast aluminium RAL 9016 (white), prepared for profile cylinder	Each	1386150	162
	Cast aluminium RAL 8028 (brown), prepared for profile cylinder	Each	1386330	162
	Brushed stainless steel, prepared for profile cylinder	Each	1386351	198
	Polished stainless steel, prepared for profile cylinder	Each	1386350	198
Lever/knob handle set for side doors				
	Standard: black plastic, prepared for profile cylinder	Each	1380000	78
	Silver finish (F2) cast aluminium, prepared for profile cylinder	Each	1380100	160
	Cast aluminium RAL 9016 (white), prepared for profile cylinder	Each	1380150	193
	Cast aluminium RAL 8028 (brown), prepared for profile cylinder	Each	1380330	193
	Brushed stainless steel, prepared for profile cylinder	Each	1380351	240
	Polished stainless steel, prepared for profile cylinder	Each	1380350	240

Garage Door Operators

Operator Accessories









Garage door operators

Boom Length	SupraMatic E	SupraMatic P	SupraMatic H	ProMatic	ProMatic Akku
K	461	492	For prices and specification see the 01-13A Price List	366	620
M	478	509		383	637
L	566	597		471	725

Garage door operators

The new hand transmitters, radio internal push buttons and code buttons with BiSecur technology are downwards compatible, i.e. they can also be used with series 1 and 2 operators (868 MHz).

- Possible
- Only in combination with a BiSecur radio receiver
- Not available

Accessory	Description	Price	SupraMatic E / P	SupraMatic H	ProMatic	ProMatic Akku	RollMatic
 HS 1 BS 1-button hand transmitter	<ul style="list-style-type: none"> Impulse High gloss plastic surface with chrome zinc diecast caps Protection category: For dry rooms only Battery: 1.5 V LR03 / AAA Dimensions: 38 x 95 x 16 mm 	52	●	○	●	●	●
 HS 4 BS 4-button hand transmitter	<ul style="list-style-type: none"> Impulse High gloss plastic surface with chrome zinc diecast caps Protection category: For dry rooms only Battery: 1.5 V LR03 / AAA Dimensions: 38 x 95 x 16 mm 	54	●	○	●	●	●
 HS 5 BS 5-button hand transmitter	<ul style="list-style-type: none"> Impulse Status query (only for SupraMatic E/P and ProMatic) High gloss plastic surface with chrome zinc diecast caps Protection category: For dry rooms only Battery: 1.5 V LR03 / AAA Dimensions: 38 x 95 x 16 mm 	Black 66	●	-	●	-	-
		White 73					
 HSS 4 BS 4-button security hand transmitter	<ul style="list-style-type: none"> Impulse Additional function: Copy protection for hand transmitter coding (e.g. home management) High gloss plastic surface in red with chrome zinc diecast caps Protection category: For dry rooms only Battery: 1.5 V LR03 / AAA Dimensions: 38 x 95 x 16 mm 	92	●	○	●	●	●
 HSE 2 BS 2-button micro hand transmitter	<ul style="list-style-type: none"> Impulse High gloss plastic surface with chromed zinc die-cast caps For fastening to key ring Incl. key ring Protection category: For dry rooms only Battery: Lithium round cell 3 V / type CR 2032 Dimensions: 28 x 70 x 14 mm 	Black 52					
		White 57	●	○	●	●	●
		5 colours 6 finishes 73					
 Hand transmitter station For hand transmitters (HS and HSS)	<ul style="list-style-type: none"> For HS 1 BS, HS 4 BS, HS 5 BS, HSS 4 BS Available in black or white 	7					
 Hand transmitter holder For hand transmitters (HS and HSS) incl. visor clip	<ul style="list-style-type: none"> For HS 1 BS, HS 4 BS, HS 5 BS, HSS 4 BS For wall fitting or for fitting to the visor clip Without fitting material 	5					

For more detailed specification and a wider range of the above products please see 01-13A Price List













Operator Accessories



Garage Door Operators

The new hand transmitters, radio internal push buttons and code buttons with BiSecur technology are downwards compatible, i.e. they can also be used with series 1 and 2 operators (868 MHz).

- Possible
- Only in combination with a BiSecur radio receiver
- Not available

Accessory	Description	Price	SupraMatic E/ P	SupraMatic H	ProMatic	ProMatic Akku	RollMatic
 HSP 4-C BS 4-button hand transmitter	<ul style="list-style-type: none"> • Impulse • With sliding switch as a button lock-out • Inc. key ring • Battery: Lithium round cell 3 V / type CR 2025 • Dimensions (D x H): Ø 48 x 13 mm 	60	●	○	●	●	●
 HSD 2-A BS 2-button hand transmitter	<ul style="list-style-type: none"> • Impulse • High-quality metal housing • As a key ring • Battery: Lithium round cell 3 V / type CR 2025 • Dimensions (W x H x D): 32 x 66 x 13 mm 	Aluminium 67	●	○	●	●	●
 HSD 2-C BS 2-button hand transmitter		Chrome 67	●	○	●	●	●
 HSZ 1 BS 1-button hand transmitter	<ul style="list-style-type: none"> • Impulse • For insertion in a vehicle cigarette lighter • Battery: Lithium 3 V / type CR 2 • Dimensions (D x H): Ø 29 x 39 mm 	50	●	○	●	●	●
 HSZ 2 BS 2-button hand transmitter		50	●	○	●	●	●
 IT 3b	<ul style="list-style-type: none"> • With illuminated impulse button, additional buttons for Internal push button • light on / off and operator on / off • With 7 m connecting lead, 2-wire • Dimensions (W x H x D): 80 x 110 x 30 mm 	35	●	●	-	-	-
 FIT 2 BS	<ul style="list-style-type: none"> • With 2 impulse push buttons for control of 2 operators per Internal radio push button radio signal, frequency 868 MHz • One additional button for On / Off function of connected command units • Connection option for max. 2 command elements • Battery: 1 x Lithium cell CR 2025 • Dimensions (W x H x D): 30 x 110 x 35 mm 	54	●	○	●	●	●
 FCT 3 BS Radio code switch	<ul style="list-style-type: none"> • Impulse, for control of up to 3 door operators • Transmission of up to 3 radio codes, 868 MHz • Power supply: Battery 4x 1.5 V LR03/AAA • Protection category: IP 54 • Dimensions (W x H x D): 80 x 135 x 45 mm 	89	●	○	●	●	●
 FFL 12 BS	<ul style="list-style-type: none"> • Impulse, to control 2 operators using a fingerprint • Up to 12 fingerprints can be taught in, cannot be individually deleted • Battery: 4 x 1.5 V LR03/AAA • Dimensions (W x H x D): 80 x 130 x 45 mm 	208	●	○	●	●	●
 HNA 18 - 3 Emergency Battery	<ul style="list-style-type: none"> • For Hörmann garage door operators series 2 and 3 • Emergency power supply to bypass power failures up to 18 hours max. 5 door cycles (depending on temperatures) • To be fixed on operator or garage ceiling • Protection category: IP 20 • Weight: approx. 2.3 kg • Operating voltage: 24 V DC/2.3 Ah • Dimensions (W x H x D): 150 x 70 x 90 mm 	141	●	●	●	-	-
 SM 1-1 Solar module	<ul style="list-style-type: none"> • For charging / buffering of operator battery • Incl. charge control, fitting material and 10 m connecting lead • Dimensions (W x H): 580 x 330 mm 	379	-	-	-	●	-
 HF 22 BS Radio set	<ul style="list-style-type: none"> • For switching light on and off to control operators of other makes • Set consists of: a 2-button hand transmitter HSZ 2 BS and a 2-channel receiver HET / S2 BS • Operating voltage 230 - 240 V AC 	150	●	●	●	●	●

For more detailed specification and a wider range of the above products please see 01-13A Price List

All prices are in £ and are exclusive of VAT

21

Warranty

Hörmann products are manufactured to the highest quality standards and leave our factory only after rigorous quality testing. However, if you should have grounds for complaint, this section tells you what our door warranty offers, and how to go about making your claim.

In the unlikely event of a warranty claim becoming necessary, please contact the dealer or distributor who originally supplied your garage door. Your dealer should then supply details of the claim, together with a copy of the warranty card provided with the door and proof of purchase to the Product Services Department at Hörmann (UK) Ltd. To enable your claim under warranty to be processed as quickly as possible, you should provide the following details:

1. Your name, address and telephone number
2. Original invoice with date of purchase
3. Product description/door type and product number
4. Description of defect

An assessment of the claim will then be made. This may require Hörmann to inspect the product in-situ. In the event that there is no legitimate warranty claim under the terms specified herein, you may be liable for the costs of the inspection visit. We strongly recommend that you take note of the care and usage instructions displayed on the stickers on the back of your garage door, and on the page opposite, and that you follow these instructions throughout.

Hörmann installers

Hörmann (UK) Ltd has a nationwide network of recommended installers who will be able to offer you a regular maintenance service on your garage door. Please call us on 01530 513050 for details of your nearest dealer.

Hörmann (UK) Ltd Garage Door Warranty

Warranty Period	The purchaser is granted a warranty covering the safe and reliable function of the Hörmann garage door for a period of 10 years from the date of purchase. A 5 year warranty applies to springs, wire cables, track rollers, hinges and guide rollers. The warranty period for replacement parts is 6 months or to the end of the current warranty period, whichever is longer. In the case of foil-coated timber-effect, a warranty of 5 years is granted, for timber and GFR doors a warranty of 2 years is granted on the door panels alone under the terms and conditions specified herein. The door mechanism and steel frame (if applicable) is covered by the 10 year warranty period.
Requirements	Warranty claims are only applicable in the country where the garage door was purchased. The product must have been purchased through our authorised distribution channels. The warranty only covers damage to the contract object. The fully completed warranty card together with the receipt of purchase correspondingly dated substantiates your right to claim under the warranty.
Performance	During the warranty period we undertake to rectify any and all defects to the Hörmann product which can be proved to be attributed to a material or manufacturing fault. We pledge at our discretion either to exchange the defective merchandise for faultless merchandise, repair it or allow a reduction in price. We do not accept costs for dismantling and installation nor for carriage. Replaced parts become our property. The warranty does not cover damage caused through: <ul style="list-style-type: none"> • normal wear and tear • improper installation • negligent care and maintenance • improper initial and subsequent operation • negligent or wanton destruction • external influences such as fire, water, salts, alkaline solutions, acids, abnormal environmental influences • mechanical damage through improper transport and fitting • priming and other surface protection treatments • incorrect or too late applied surface protection treatments • repair by non-qualified persons • using non-Hörmann parts without the approval of the manufacturer • removal of the product number or making it unidentifiable

Electric Operator Warranty

A separate 5 year warranty is granted on our electric operators. This includes operator mechanics, motor and motor control systems. A 2 year warranty is granted on radio equipment, accessories and system controls. There is no warranty on consumables (e.g. fuses, batteries, bulbs etc.). For further details please contact us on 01530 513030 or through our website on www.hoermann.co.uk

User Information/Care

Finish - Steel Doors

The coating process applied to the door and chassis is environmentally friendly. Minor scratches or marks are not covered under the conditions of our warranty and should be repaired immediately to prevent corrosion and deterioration of the panel. Corrosive substances such as acids, alkalines, and salts, etc. should be cleaned from the door immediately; failure to do so will result in deterioration of the finish, which will not be covered under our warranty. Should deterioration of the finish start to occur you will need to repaint your door immediately. Prepare the surface lightly with wet and dry. Then treat with solvent based 2 pack epoxy wash primer and a normal commercial paint (cellulose paint must not be used). Hörmann steel doors are a finished product. They do not require re-painting on site. They are however not immune to damage, which can occur at any stage of the handling of the product from factory to site.

Finish - Timber Doors

Timber panels are coated with a neutralising base-stain. Doors must be stored upright, under cover, with wrapping intact, until wrapping is removed. As soon as the door is unwrapped, one coat of a good quality basecoat primer must be applied to both sides of the door. Immediately after installation, your timber doors require a further two coats of a good quality exterior wood finish on both sides. Initial application and periodic treatment should be carried out strictly in accordance with the woodstain manufacturer's instructions. Failure to follow these instructions will result in early deterioration of the timber panel.

Finish - GFR Doors

GFR door panels should periodically be washed down using water. This should be done more frequently if fitted near the sea. Bird droppings will bleach the finish on GFR and should be removed using water as soon as possible. GFR doors should not be painted over.

Paint Finish - Steel Doors

Minor surface damage can easily be repaired using touch up sprays or sticks without invalidating warranties.



Extracts from DHF consumer advice

The following document was designed by the Association of Garage Door Specialists, updated by the DHF and endorsed by all major UK garage door manufacturers, as a guide for purchasers of domestic garage doors.

Visual appearance of Garage Doors

A new garage door can be a significant investment that will transform the appearance of your home. This information is a guide to the quality you can expect.

The Quality Check

The quality check should be carried out in natural daylight, not direct sunlight. Stand at a distance of 3 metres from the door to view the overall appearance. The door is acceptable if, taking into account the facts below, none of the following are readily visible on the face of the door:

- Marks or distortion associated with the manufacturing process
- Minor indentations, marks or scuffs on the surface
- Paint or stain blemishes

The Facts

Steel Doors

Panel Distortion The rolling or pressing of steel panels during manufacture will cause distortion in the steel and while every effort is made to keep this to a minimum, inevitably some visible distortion will remain. The application of high gloss paints will make this slight distortion more apparent, especially under certain lighting conditions, such as car headlamps, or bright sunshine.

Paint Finish Primed doors - the primer coating is applied as a base coat only and as such requires additional finishing with a good quality exterior paint. Any marks or scratches on the primer coat should be rubbed down and repainted as part of this finishing process.

Finished doors - the factory application of the paint finish is an automated process and this may result in minor blemishes or slight inconsistencies in the paint, particularly in the area of panel joints.

Timber Doors

Timber Timber is a natural product and there will be variations in pattern, colour, shading and grains. No two doors will be the same, because wood naturally expands and contracts according to environmental conditions, joints will open and close and some minor curvature may occur.

It is vital that timber doors are fully finished as per the manufacturers instructions before exposure to the elements.

GRP and Composite Plastic Doors

Mould Marks GRP doors are individually handcrafted in a mould and are then hand finished. Some minor marks and blemishes will inevitably remain after this process.

Translucency When viewed from the inside, it is often possible to see variations in the translucency of the door, particularly around and between areas of relief. Such variations do not detract from the overall strength or build quality of the door.

All Doors

Colour Match Pairs of doors should be ordered together to obtain the best colour match, bearing in mind the limitations of the materials used in the construction. Timber garage doors cannot be ordered as matching sets.

Size Variation As the size of a door changes in height and/or width, the panel frequency and profile can change, therefore doors of the same style but of different sizes can be significantly different in appearance.

Clearances All doors require operating clearances, i.e. the gap between the door panel and the frame opening, these are inbuilt during manufacture and should not be reduced by means of infills, or draughtproofing.

Deflection When in the open position, all doors will display a level of vertical deflection or "sag" across the width of the panel. Individual manufacturers' specifications should be consulted for exact tolerances.

Power Operated Garage Doors

It is against the law to install a power operated garage door in the UK without complying with the Machinery Directive.

To comply with the Machinery Directive both the door and the operator used in the installation must have a Declaration of Incorporation from the manufacturer.

On completion of the installation the installer must provide a Declaration of Conformity and apply a CE mark giving details of the installation to the door / operator combination, which is now classed as a machine.

The installer must issue to the customer a Declaration of Conformity on completion of the installation.

The installer must hold copies of both the Declaration of Incorporation and the Declaration of Conformity on a technical file for inspection by the relevant authorities.

If any of the above requirements are not fulfilled the installation is illegal.

Please ensure for your own safety and peace of mind that whoever installs your electric operator is both willing and able to fulfil these requirements; if they are not - do not use them!

Members of the DHF Garage Door Installer Group can and will install your Hörmann operator safely and legally.

Since the company's policy is one of continuous improvement of its products, we reserve the right to make any alterations in design, manufacture or price. All business is governed by the company's Standard Conditions and this document does not form any part of any contract with the company and statements contained in it should not be construed as representations or warranties.