

# FrontGuard Steel Entrance Doors

**NEW** Door models with stainless steel design elements







## Enjoy the benefits of a FrontGuard door

Garador FrontGuard doors are amongst the best front doors available on the market today. The high quality becomes apparent as soon as you operate one of these doors for the first time. The excellence in production and the use of high grade materials will ensure good thermal insulation, high security and optimal functionality for many years. Available in a range of designs and colours, there is certainly a door for every property.

Garador FrontGuard doors are amongst the most thermally insulated doors in Europe. The door panel is filled with highly efficient insulating foam. The door frame as well as the door seals are specially engineered to minimize the loss of heat and eliminate thermal bridges. Installing a FrontGuard door may lead to significant energy savings.

Secured by Design is an association focusing on the design of more secure homes and commercial properties. Secured by Design is owned by the ACPO (Association of Chief Police Officers) and awards the Secured by Design status to products that pass their extensive testing procedures. Secured by Design is available as an option on most of our front door designs. Look out for the logo throughout this brochure.

For more information on FrontGuard front entrance doors and other Garador products please visit [www.garador.co.uk](http://www.garador.co.uk)



A thermal efficient front door can help reduce your energy costs dramatically. Please see page 13 and find the results from our thermal efficiency tests.





## Break in resistant locking

Because you and your family want to feel safe at home, the doors are equipped with multiple-point locking as standard for extra security. The hinge side of the doors is secured with three security bolts. A continuous safety device strip secures our doors against forced opening, giving you a reassuring feeling.

### Break in resistant RC 2 security equipment

RC 2 describes the door's resistance class against a break in and corresponds to the former class WK 2.



All Garador FrontGuard doors, including those with side elements and transom lights, also come with RC 2 equipment for more security for you and your family. Many of the designs also have Secured by Design accreditation.

## Shatterproof glazing

Garador FrontGuard doors are equipped with double glazing as standard, whilst FrontGuard Plus doors incorporate triple glazing for even greater thermal efficiency. While the outside glazing consists of laminated security glass, the inside pane is safety glass, which means, should the pane ever burst, it will not break into little sharp edged pieces - considerably reducing the risk of injury for you and your family.

# Garador FrontGuard

## 1 Thermal Insulation

With the dense PU-foam door leaf and the thermal break built into the panel design these doors provide excellent thermal insulation for your home with a U-value as low as 1.2 W/m<sup>2</sup>·K.

## 2 Frame

The 60 mm aluminium frame also has a thermal break built into its design to further maintain its thermal performance. The rounded version (top image) or the rectangular frame (bottom image) also offer you further design choices.

## 3 3 way adjustable hinges

With these fully adjustable 3 way hinges the doors can be perfectly adjusted, thus providing a door that is not only lightweight in operation but seals perfectly. The aluminium hinge caps also provide a sleek finish after adjustment.

## 4 5-point security lock

2 conical swing bolts, 2 security bolts and 1 additional lock bolt all engage into the frame's lock plates whilst pulling the door further into the frame seals for maximum security.

## 5 Internal handle

A stainless steel internal handle provides a quality robust feel to the door and the matching profile cylinder is supplied with 5 keys as standard.

## 6 Seals

The door and frame have been designed to reduce heat loss and with the low 20 mm aluminium / plastic threshold and thermal break linked to the double seals on the bottom of the door ensures minimal heat loss.

### Break in resistance

The FGS 700 / 900 / 010 / 015 and 100 door styles come optionally without side elements and transom lights with RC2 equipment. The doors are also approved for fitting either opening inwards or outwards of the opening.

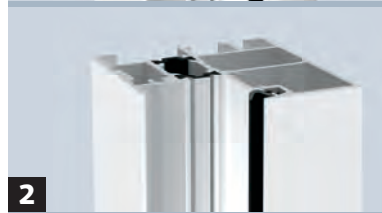
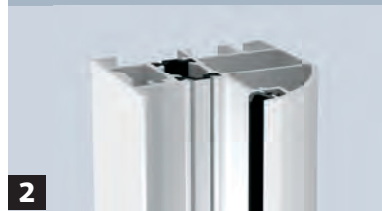

# Garador FrontGuard Plus

## 1 Thermal Insulation

With an extra thick door leaf filled with thermally efficient PU foam and a thermal break built into the panel design, FrontGuard Plus doors provide excellent thermal insulation for your home with a U-value as low as 0.81 W/m<sup>2</sup>·K.

## 2 Frame

The 80 mm aluminium frame also has a thermal break with PU foam infill built into its design to further maintain its thermal performance. The rounded version (top image) or the rectangular frame (bottom image) also offer you further design choices.

## 3 3 way adjustable hinges

With these fully adjustable 3 way hinges FrontGuard Plus doors can be perfectly adjusted, to provide a door that is not only lightweight in operation but seals perfectly. The aluminium hinge caps also provide a sleek finish after adjustment.

## 4 5-point security lock

2 conical swing bolts, 2 security bolts and 1 additional lock bolt all engage into the frame's lock plates, whilst pulling the door further into the frame seals for maximum security.

## 5 Internal handle

A stainless steel internal handle provides a quality robust feel to the door and the matching profile cylinder is supplied with 5 keys as standard.

## 6 Seals

On FrontGuard Plus doors both the door leaf and the frame have extra features designed to reduce heat loss. The low 20 mm aluminium / plastic threshold with thermal break, in conjunction with a durable triple rubber seal on the bottom of the door gives you a reinforced seal that will undoubtedly help to keep your home warm and keep the wind, rain and snow outside.

### Break in resistance

The FrontGuard Plus range, including those with side elements and transom lights, are available with RC2 equipment as an option. The doors are also approved for fitting either opening inwards or outwards of the opening.

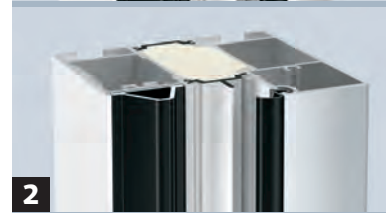
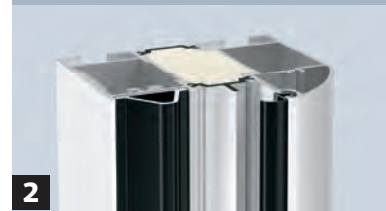



# Certified manufacturing excellence

All FrontGuard doors are manufactured in line with ISO 9001 and regularly subjected to the strictest quality tests in order to provide a product that is: water tight under heavy rain, air tight under heavy winds, providing acoustic and thermal insulation and security.

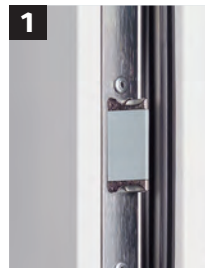

Soft lock latch

### 5-point security lock

You will feel safe at home: 2 conical swing bolts engage with 2 additional security bolts and 1 lock bolt in the frame's lock plates and pull the door tightly shut. The lock plate on FrontGuard Plus doors is adjustable for an optimal door setting. With a soft lock latch to quietly close the door.



Locking rod



Swing bolt with security bolts



GARADOR Brand quality will win you over in every respect



FrontGuard with 3 security bolts



FrontGuard Plus with continuous safety device strip made of aluminium

### Securing the hinge side

All FrontGuard and FrontGuard Plus doors are fitted with 3 additional security bolts on the side hinges, making it practically impossible to force the door open, so you can take comfort in the knowledge that your door is secure.

## Handles and hinges



### Perfectly hung with 3 way adjustable hinges

FrontGuard and FrontGuard Plus doors feature 3 way adjustable hinges with safety pins for quick and easy installation. These hinges can be precisely adjusted to ensure a smooth door action. The hinges are supplied with stainless steel covers for a sleek modern look.

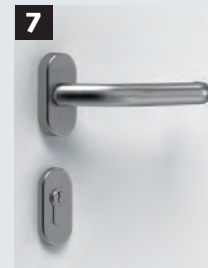

### Internal Handle

Each door features a contemporary stainless steel handle and rose escutcheon on the outside of the door.



8

### Lock and key

Doors are designed with a security function whereby the door cannot be opened with a key from the outside if a key is left inserted inside.

## Optional extras for added convenience

### Electric strike

With the electric strike plate, you can conveniently open your door via a switch inside the house. Alternatively you can also toggle the locking lever so that the entrance door can be opened by a slight push from the outside.

### Window drip

The door drip in Traffic white RAL 9016 diverts driving rain and is easy to retrofit.

## Modern designs, lasting elegance

Our modern design FrontGuard doors feature a superb high gloss surface finish. An unmatched combination of excellent thermal insulation and exclusive appearance to enhance energy savings and beautify your home.

In addition to the entrance door, we offer side elements and transom lights in a variety of designs. For more information see page 18.



1



2

/// Triple Glazed



3\*

/// Triple Glazed

- 1 FGS 700, White (RAL 9016), SBD
- 2 FGS 750, White (RAL 9016),
- 3 FGS 850, White (RAL 9016),
- \* only available as FrontGuard Plus

GARADOR *Modern design*



4



**FSG** 700 / 750 / 850 / 900

Our glazed FrontGuard entrance doors feature high quality, insulated laminated safety glass.

Triple pane insulated glazing (44 mm) provides an excellent thermal insulation (see page 20). A flush fitting appearance on the interior and exterior, as well as a stainless steel glazing frame, underscore the door's elegant look.

**Stainless steel handle**



These doors come complete with a 1000 mm long robust bar handle made from high quality stainless steel which blends perfectly with the design elements of the door.

To Individualise your door see page 18 - 21 for more design options.



5

**NEW**



6

**NEW**

- 4 FGS 900, White (RAL 9016), with side elements
- 5 FGS 800, Titan metallic effect surface finish
- 6 FGS 810, White (RAL 9016)



## Stylish and appealing contemporary designs

Our contemporary series of FrontGuard steel entrance doors feature modern accents to provide a new and contemporary design. The wide range of glazing and colour options allow you to create the door that perfectly matches your property.

For wide entrances we offer matching side elements and transom lights. Please contact us for detailed information. For more information on options, side elements and transom lights see page 18 - 21.



1



2



3

NEW

- 1 FGS 010, Anthracite grey (RAL 7016), SBD
- 2 FGS 025, Titan metallic effect surface finish
- 3 FGS 015, Titan metallic effect surface finish, optionally with embellishments in stainless steel look

GARADOR Contemporary design



4



5



6



- 4 FGS 020, White (RAL 9016)
- 5 FGS 030, Timber effect Dark Oak surface finish, SBD
- 6 FGS 040, Window grey (RAL 7040), SBD



FSG 020 / 025 / 030 / 040

Our glazed FrontGuard entrance doors feature high quality, insulated laminated safety glass.

The double pane insulated glazing (24 mm) is characterised by high thermal insulation (see page 21). A modern, harmonious door appearance is created with a round-style composite glazing frame.

#### Stainless steel handle



As standard, the exterior of the door is equipped with a stainless steel handle bar handle 330 mm long. A perfect combination in terms of shape and material.

To Individualise your door see page 18 - 21 for more design options.

## Classic design – timeless and prestigious

Here is our range of steel classic design FrontGuard entrance doors. They blend in with almost any home and perfectly match a classic steel garage door with raised panels. All of our classic design steel doors come with a lever/lever handle as standard, available in silver or gold.



1



2



3

- 1 FGS 100, Moss green (RAL 6005), SBD
- 2 FGS 200, White (RAL 9016), SBD
- 3 FGS 400, Ruby red (RAL 3003)



For wide entrances we offer matching side elements and transom lights, either solid or with windows.  
For more information see page 18.



FSG 200 / 400

Our glazed FrontGuard entrance doors feature high quality, insulated laminated safety glass.

The double pane insulated glazing (24 mm) offers high thermal insulation (see page 21). The profile style composite glazing frame perfectly blends in with the classic panel look.



4

Lever handle options



Lever handle set available in silver and gold



Lever/knob handle set available in silver and gold



Lever handle set Secured by Design available in silver and gold



Lever/knob handle set Secured by Design available in silver and gold

Secured by Design handle sets come with a cylinder guard protecting the cylinder from being drilled or forced out.

To Individualise your door see page 18 - 21 for more design options.



## Automatic locks

Open your door easily and conveniently via multiple-point locking using a hand transmitter, radio finger-scan or transponder.

When operating the entrance door via a hand transmitter or radio finger-scan, it automatically unlocks via an electric motor. You can then push the door open.

For opening with a transponder, the entrance door is equipped with an electromechanical profile cylinder. Hold the transponder in front of the cylinder to unlock and open your door using the knob.



Hand transmitter

**NEW**



Radio finger-scan

**NEW**



Transponder

**NEW**



## Matching side elements and transom lights

Each FrontGuard entrance door can be supplied with a matching side element and / or transom light. FrontGuard Plus doors come with triple pane insulated glazing.

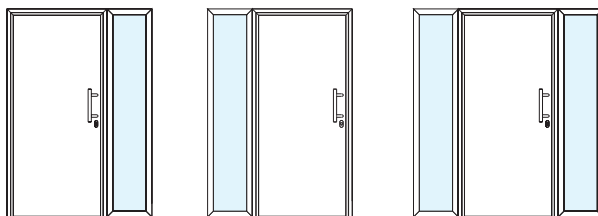

Side elements

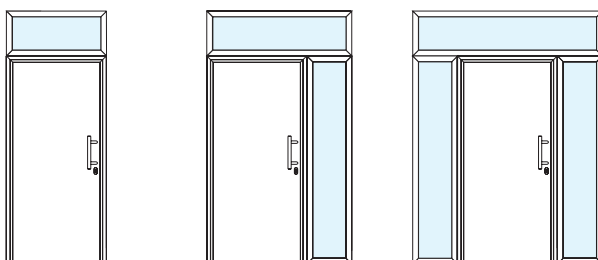

Transom lights  
and side elements

Please refer to individual door types for glazing options available.  
Choose from our glass designs for your individual style:

Glazing options

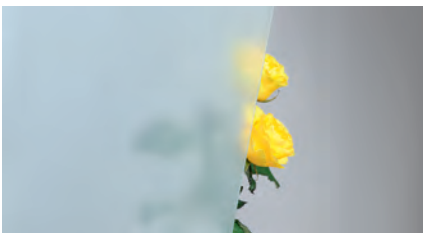

Sand blasted Float glass  
(standard on Modern doors)



Clear Float glass  
(standard on Modern doors)

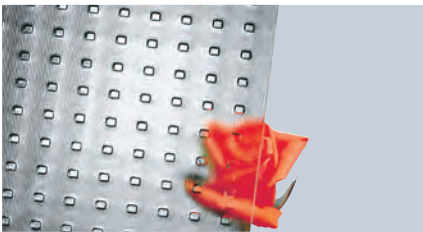

Mastercarré design  
(standard on Contemporary doors except FGS 040)



Ornamental glass  
(standard on FGS 040)



Hammered glass  
(standard on Classic doors)



## Modern



Door	700	750	800	810	850	900
FrontGuard U-value [down to ... W/m <sup>2</sup> ·K]	1.3	1.2	-	-	-	1.2
FrontGuard Plus U-value [down to ... W/m <sup>2</sup> ·K]	0.98	0.95	0.93	0.99	0.96	0.96
Glass type	Sand blasted without clear stripes					
Overall frame Standard sizes [width x height in mm]	1000 x 2100 1100 x 2100					
Special size range width [in mm]	875 - 1250					
Special size range height [in mm]	1990 - 2250					

## Colours and surface finish

White RAL 9016						
White aluminium RAL 9006						
Terra brown RAL 8028						
Clay brown RAL 8003						
Window grey RAL 7040						
Light grey RAL 7035						
Anthracite grey RAL 7016						
Moss green RAL 6005						
Ruby red RAL 3003						
Pigeon Blue RAL 5014						
Light Ivory RAL 1015						
Timber-effect Golden Oak						
Timber-effect Winchester Oak						
Timber-effect Dark Oak						
Timber-effect Night Oak						
Titan metallic effect						

## Side element

Infill	Glass, clear or sand-blasted to choose
Standard size [width x height in mm]	400 x 2100
Special size range width [in mm]	300 - 1000
Special size range height [in mm]	1875 - 2250

## Transom light

Infill	Glass, Float clear or sand-blasted to choose
Special size range width [in mm]	875 - 2250
Special size range height [in mm]	300 - 500



GARADOR Options

Contemporary

Classic



010

015

020

025

030

040

100

200

400

1.1	1.1	1.4	1.4	1.3	1.2	1.1	1.2	1.5
0.87	0.87	-	-	-	-	-	-	-
n/a		Mastercarré			Orna-mental	n/a	Hammered	

						875 - 1100		
1875 - 2250		1990 - 2250			1875 - 2250		1990 - 2186	

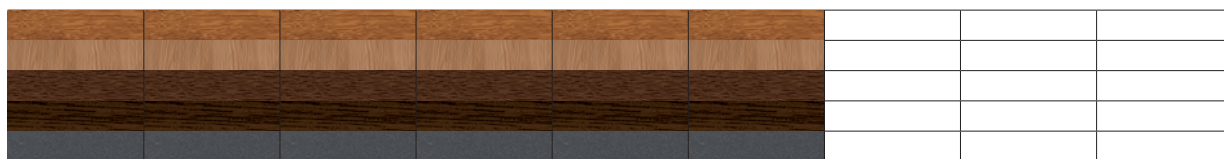
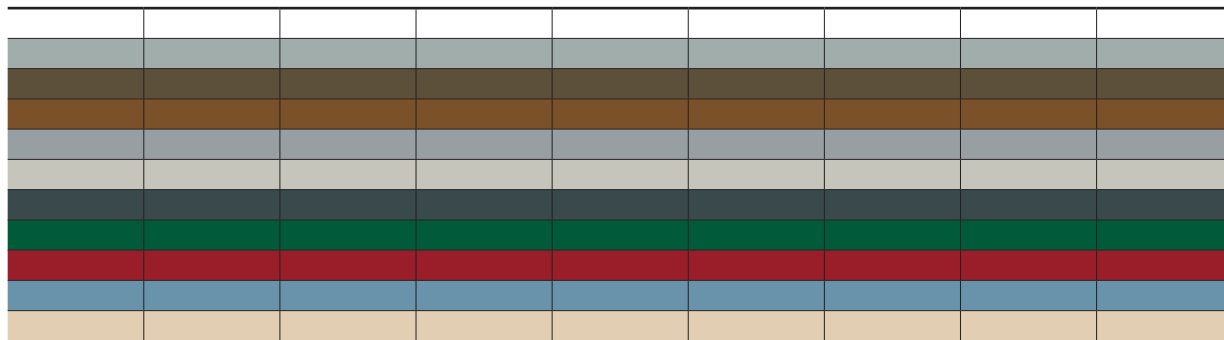

Glass, all types	Glass, Mastercarré or clear to choose	Glass, Ornamental or clear	Matching solid panel or partly glazed with Hammered glass
400 x 2100			450 x 2100
300 - 1000			Panel side elements are 450 only Glass side elements are 300 - 1000 only
1875 x 2250	1990 x 2250	1875 x 2250	1875 x 2186

Glass, all types	Glass, Mastercarré or clear to choose	Glass, Ornamental or clear	Glass, Hammered
875 - 2250			875 - 2000

300 - 500

Horizontal view of door

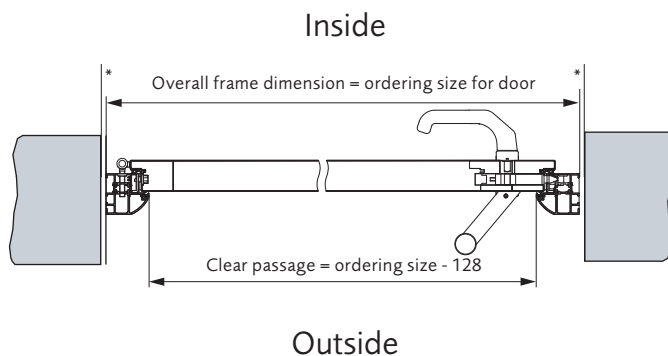

Horizontal view of side element

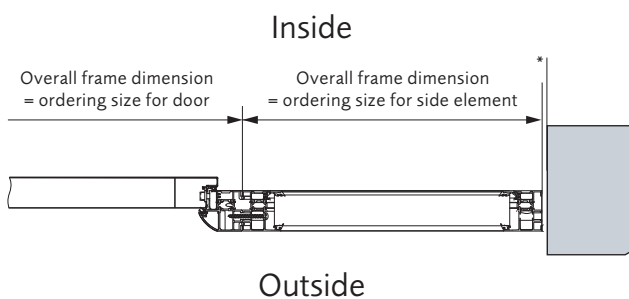

Vertical view of door

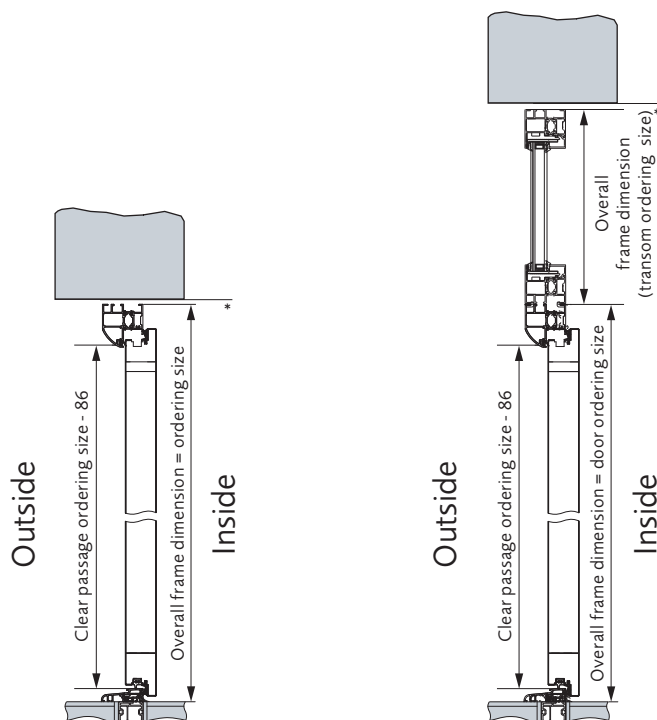

\* Doors are designed to be fitted to a finished opening and then allow your fitting tolerance.

GARADOR *The perfect match*

## Enjoy the beauty and convenience of a matching garage door

Besides the entrance door, the garage door is one of the key elements of your property. We offer a wide range of steel sectional doors and roller doors, together with matching operators, all providing the convenience, safety and security you deserve.

Please ask for our detailed brochures to see the range of finest garage doors and operators available.

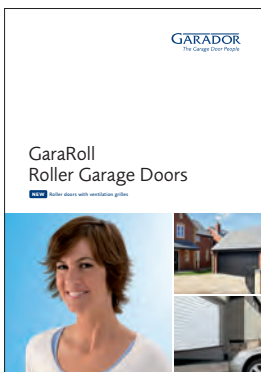
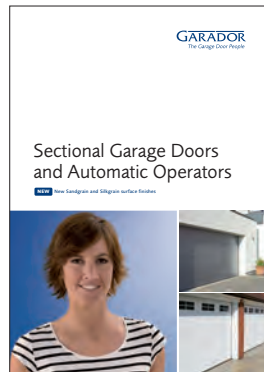
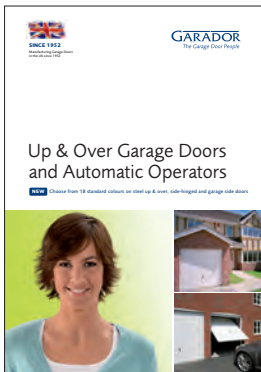



# GARADOR

*The Garage Door People*

Bunford Lane, Yeovil, Somerset, BA20 2EJ

Tel: (01935) 443722 Fax: (01935) 443744

[www.garador.co.uk](http://www.garador.co.uk)



Garador is the UK's leading manufacturer of garage doors and operators, with an ultra-modern production facility located in Somerset. We use German engineering expertise to produce highly sophisticated doors and operators. By purchasing a Garador product you can be assured of the highest level of quality, safety and security. With a nationwide network of stockists, installers and service technicians we are an ideal partner for your project.