

GARADOR
The Garage Door People

The Garador Range Spares Catalogue

June 2017 Up & Over Doors, Side-Hinged Doors and Operators

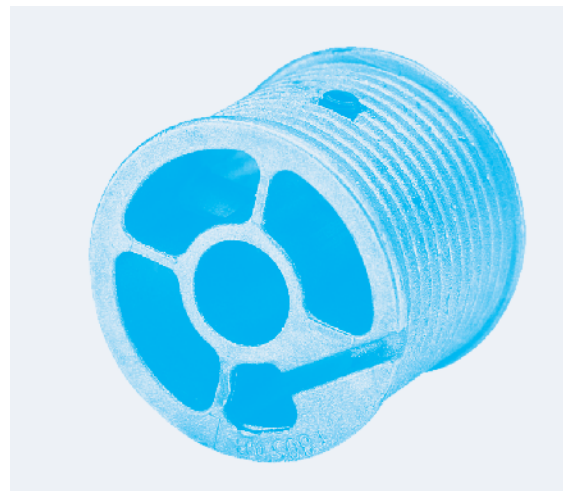

General Information

All prices are quoted in £ Sterling, ex-works and exclusive of VAT.

All orders for spares will be subject to a minimum P&P charge, please check cost when ordering. All items are listed and priced as single items unless specified.

Please ensure that you order the correct component for your specific door, parts ordered incorrectly will be subject to a restocking charge if being returned. For handing of component, the door should be viewed from the inside, looking at the back of the panel. Please contact Garador on 01935 443722 if you need assistance in identifying the correct part.

Since the company's policy is one of continuous improvement of its products, we reserve the right to make any alterations in design, manufacture or price.

All business is governed by the Company's Standard Conditions and this document does not form any part of any contract with the company and statements contained in it should not be construed as representations or warranties.

For more information please visit
www.garador.co.uk







GARADOR

Contents

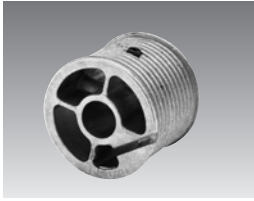
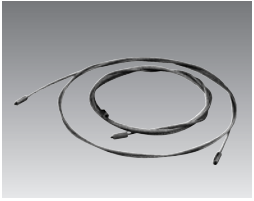
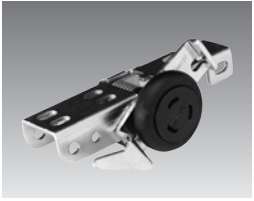

Up & Over Doors (2002 - current)	4
Canopy Doors	4
Retractable Doors	5
Retractable Plus Doors	7
Handles, Lock Assembly and Keys	10
Weather seal components	12
Up & Over Doors (Pre 2002)	13
Pre-2002 Spring Ref No. Conversion Chart	13
Mark 3C Accessories for Overhead Spring Box Pre 1999 (canopy)	19
Accessories for Mark 4 / F-Type Doors (canopy)	24
Accessories for doors with C Type Side Extension Springs 1999 - 2002 (canopy)	29
Single and Double Retractable Gear Components	34
Double Canopy Doors	35
Handles, Lock Assemblies and Keys	38
Garage Side Doors (2002 - current)	39
Electric Operators	40
GaraMatic Operators	40
EuroPro	44
Autodor	44
Consumables	45
Bulbs and Batteries	45
Touch Up Paint	46
Warranty	47

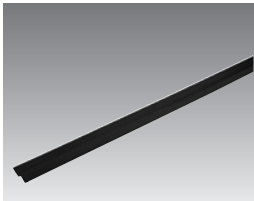
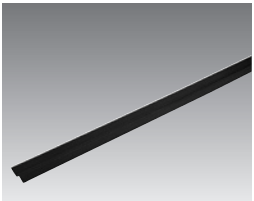
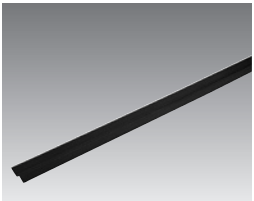
Canopy Doors

				
Article	Cable Drum 2002 - current	Canopy Cables Sold in pairs. 2002 - current	Safety Latch and Roller For canopy doors. 2002 - current	Door Top Weatherstrip 2002 - current
Ref. No.	(LH) 57, (RH) 58	45	(LH) 127, (RH) 128	110
Price £	11.00	24.00 (per pair)	25.00	14.00

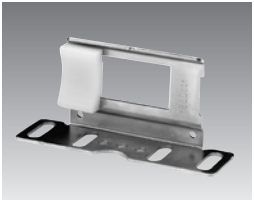
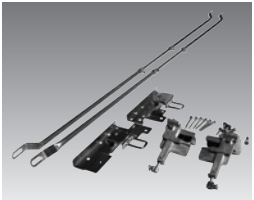
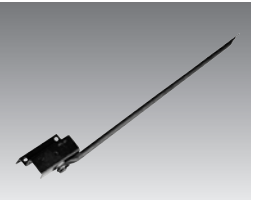

				
Article	Bottom Weatherstrip for Timber Frame Cut to length. 2002 - current	Rubbing Strip for Steel Frame Cut to length. 2002 - current	Bottom Weather Strip for Steel Frame Specify door height when ordering. 2002 - current	Spring Assembly Specify door width when ordering. 2002 - current
Ref. No.	111	109	108	1223 (state size on order)
Price £	14.00	15.00	15.00	84.00

				
Article	Door Latch Assembly 2002 - current	Door Latch Keeper 2002 - current	Additional Lock Kit For canopy doors. 2003 - current	Canopy Link Arm Assembly Steel/Timber 2002 - current GRP 2006 - current
Ref. No.	122	126	1768	145
Price £	10.00	10.00	53.00	41.00

			
Article	Canopy Link Arm Assembly GRP 2002 - 2006	Canopy Track Assembly Includes cable and roller. 2002 - current	Canopy Tensioning Bars
Ref. No.	187	160161	1222
Price £	41.00	55.00	16.50

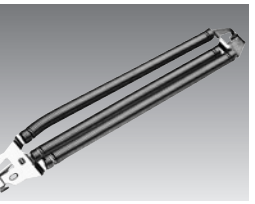

GARADOR *Up & Over Doors (2002 - current)*

Retractable Doors

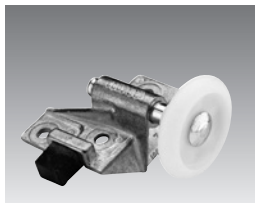
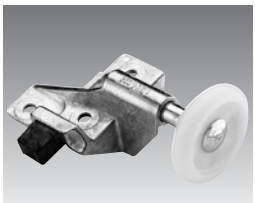
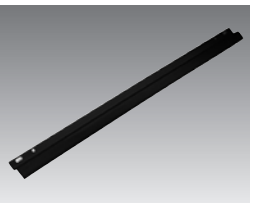
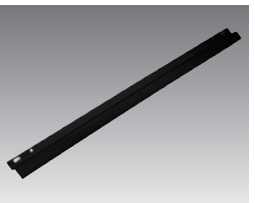
				
Article	Retractable Spring Assembly 001 2002 - current	Retractable Spring Assembly 002 2002 - current	Retractable Spring Assembly 003 2002 - current	Retractable Spring Assembly 004 2002 - current
Ref. No.	52	53	54	1226
Price £	40.00 (each)	40.00 (each)	40.00 (each)	40.00 (each)

				
Article	Roller Bracket Assembly For all framed retractable doors. 2002-2003	Roller Bracket Assembly For all framed retractable doors. 2003 - current	Retractable Top Weatherstrip for 6'6" high door	Retractable Top Weatherstrip for 7'0" high door
Ref. No.	(LH) 123, (RH) 124	(LH) 120, (RH) 121	104	105
Price £	32.00	25.00	14.00	14.00

				
Article	Pivot Block (Panel) For retractable doors. 2004 - current	Pivot Block (Frame) 2004 - current	Finger Trap Protection For retractable doors. 2004 - current	Retractable Link Arm Assembly for steel frame. 6'4" 2002 - current
Ref. No.	(LH) 251, (RH) 252	(LH) 88, (RH) 89	100	(LH) 4668, (RH) 4669
Price £	13.00	11.00	12.00	33.00

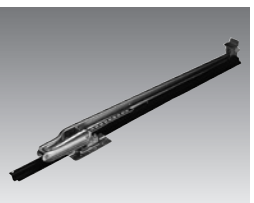
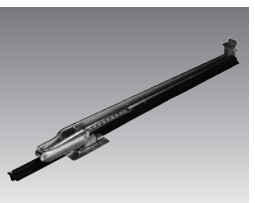
				
Article	Retractable Link Arm Assembly for steel frame. 6'6" 2002 - current	Retractable Link Arm Assembly for steel frame. 7'0" 2002 - current	Retractable Link Arm Assembly for timber frame. 6'4" 2002 - current	Retractable Link Arm Assembly for timber frame. 6'6" 2002 - current
Ref. No.	(LH) 4670, (RH) 4671	(LH) 4672, (RH) 4673	(LH) 4834, (RH) 4835	(LH) 4836, (RH) 4837
Price £	33.00	33.00	42.00	42.00

Retractable Doors

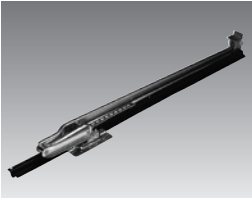
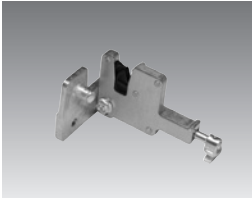
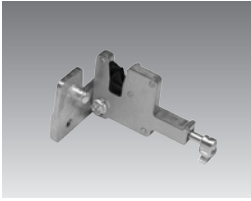
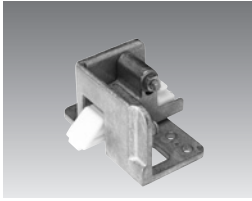
				
Article	Retractable Link Arm Assembly for timber frame. 7'0" 2002 - current	Retractable Latch For steel doors 2005 - current	Retractable Latch For timber doors 2005 - current & GRP doors (gold in colour). 2006 - current	Retractable Latch For steel doors (2002 - 2003) and GRP Doors (2002 - 2006)
Ref. No.	(LH) 4838, (RH) 4839	(LH) 2790, (RH) 2791	(LH) 3076, (RH) 3077	(LH) 180, (RH) 181
Price £	42.00	27.00	27.00	27.00

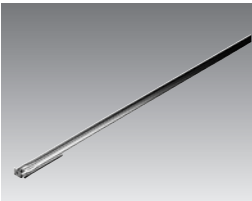
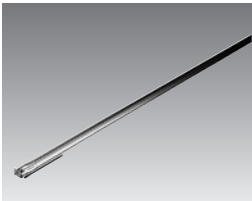
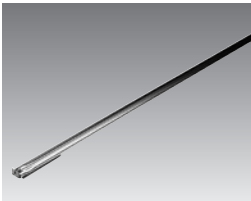
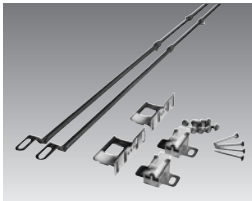

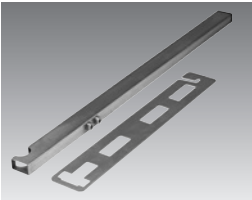
				
Article	Retractable Track Assembly Up to 10'0" wide - 6'4" high only. 2002 - current	Retractable Track Assembly Up to 10'0" wide - 6'6" high only. 2002 - current	Retractable Track Assembly Up to 10'0" wide - 7'0" high only. 2002 - current	Additional Lock Kit For retractable doors. 2003 - current
Ref. No.	(LH) 269, (RH) 270	(LH) 271, (RH) 272	(LH) 273, (RH) 274	1769
Price £	40.00	40.00	40.00	53.00

	
Article	Tensioning Tool For retractable doors 2002 - current
Ref. No.	1909
Price £	76.00

GARADOR *Up & Over Doors (2002 - current)*

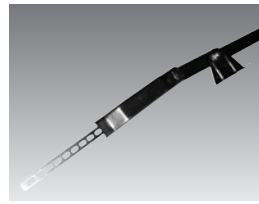
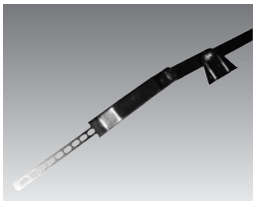
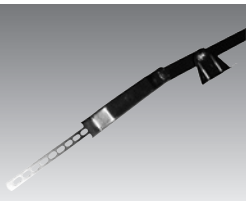
Retractable Plus Doors

			
Article	Retractable Plus Link Arm Assembly For timber and steel frame 6'4" Weather strip not included	Retractable Plus Link Arm Assembly For timber and steel frame 6'6" Weather strip not included	Retractable Plus Link Arm Assembly For timber and steel frame 7'0"
Ref. No.	2617	2618	2619
Price £	40.00	40.00	44.00

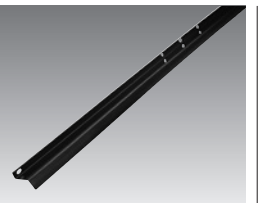
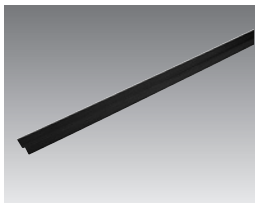
				
Article	Top Weather Strip For 6'4" retractable plus doors, timber and steel frame. 2005 - current	Top Weather Strip For 6'6" retractable plus doors, timber and steel frame. 2005 - current	Top Weather Strip For 7'0" retractable plus doors, timber and steel frame. 2005 - current	Bottom Weather Strip For 6'4" retractable plus doors, timber and steel frame. 2005 - current
Ref. No.	2677	1709	1710	2675
Price £	14.00	14.00	14.00	16.00

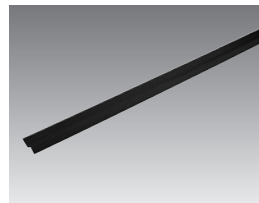
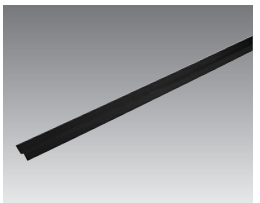
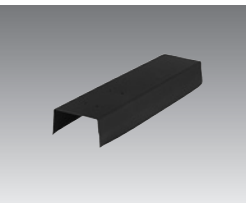

			
Article	Bottom Weather Strip For 6'6" retractable plus doors, timber and steel frame. 2005 - current	Bottom Weather Strip For 7'0" retractable plus doors, timber and steel frame. 2005 - current	Finger Trap Protection For retractable plus doors. 2005 - current
Ref. No.	1699	1700	1844
Price £	16.00	16.00	12.00

Double Retractable Doors

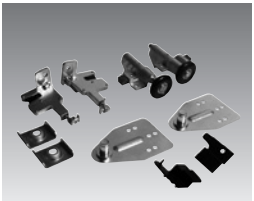
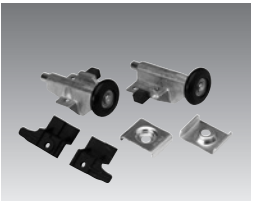
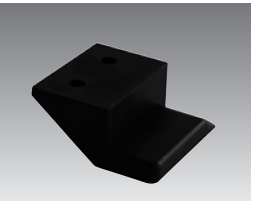
				
Article	Double Door Spring Assembly 4er 025 2004 - current	Double Door Spring Assembly 4er 032 2004 - current	Double Door Spring Assembly 023 2004 - current	Double Door Spring Assembly 615 2004 - current
Ref. No.	1946	1945	4346	1943
Price £	53.00 (each)	53.00 (each)	53.00 (each)	53.00 (each)

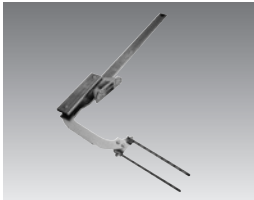
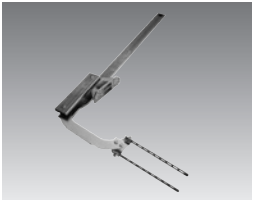
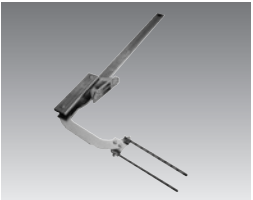
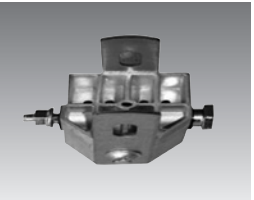
				
Article	Double Door Spring Assembly 621 2004 - current	Double Door Latch and Roller Pack	Double Door Top Roller and Bracket Pack 2002 - current	Frame Pivot Block For double doors
Ref. No.	1944	4333	1940	(LH) 4272, (RH) 4273
Price £	53.00 (each)	110.00	60.00	11.00

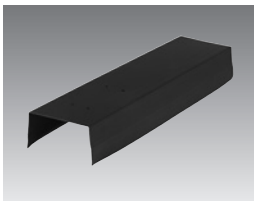
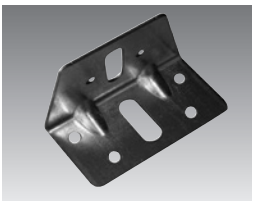
				
Article	Link Arm 1931 mm 6'4" 2009 - current	Link Arm 1980 mm 6'6" 2009 - current	Link Arm 2036 mm 7'0" 2009 - current	Spring Coupling Bracket For double doors
Ref. No.	(LH) 6013, (RH) 6014	(LH) 4278, (RH) 4279	(LH) 4280, (RH) 4281	4379
Price £	96.00	96.00	96.00	45.00

				
Article	Finger Trap Protection For double doors	Track/ Wall Bracket For double doors	N800 Double Door Latch Keeper For steel frames	N800 Double Door Latch Keeper For timber frames
Ref. No.	4285	4284	(LH) 4275, (RH) 4276	(LH) 4306, (RH) 4307
Price £	12.00	14.00	54.00	54.00

GARADOR *Up & Over Doors (2002 - current)*

Double Retractable Doors

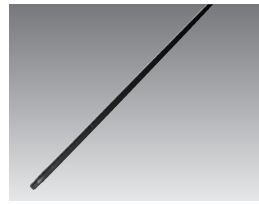
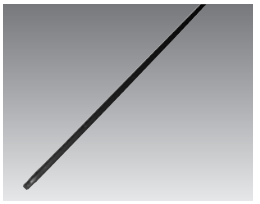
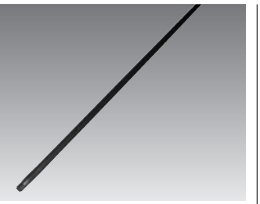
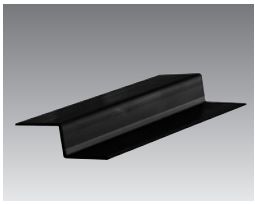
				
Article	N800 Double Door Track 1980 mm L/ R	N800 Double Door Track 2139 mm L/ R	N800 Double Door Track 1931 mm L/ R	Bottom Frame Weatherstrip 1980/2136 For double doors 6'6" high
Ref. No.	4372	4373	6015	4310
Price £	58.00	58.00	58.00	17.00

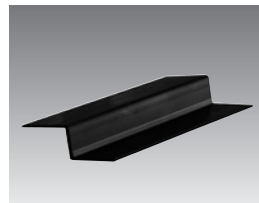
	
Article	Bottom Frame Weatherstrip 1980/ 2136 For double doors 7'0 high
Ref. No.	4311
Price £	17.00

Handles, Lock Assembly and Keys





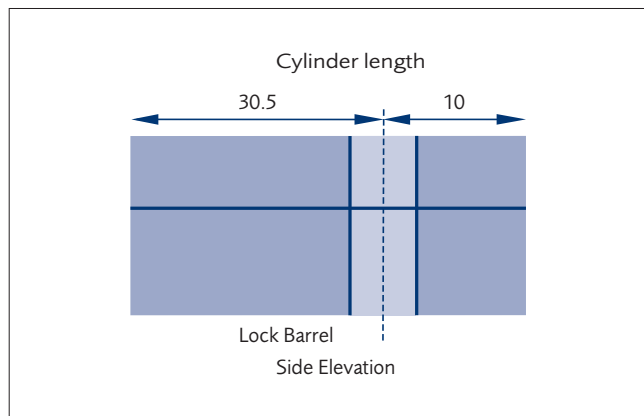

	Doortype	Cylinder Length	Ref. No.	Price £
Lock Body with Cylinders (2003 - Current)	Suitable for all Carlton, Horizon, Salisbury, Chevron and all double steel doors	30.5 + 10	204	34.00
Lock Body with Cylinders (2003 - Current)	Suitable for all Georgian, Beaumont, Cathedral, Sherwood and Wentwood doors	35 + 10	202	34.00
Lock Body with Cylinders (2003 - Current)	Suitable for all Tudor, Seymour, Wolsey, Shaftsbury and single GRP doors	40 + 10	203	41.00
Lock Body with Cylinders (2002 - Current)	Suitable for all GRP and timber doors	50.5 + 10	1796	41.00
Lock Body with Cylinders (2003 - Current)	Suitable for all Sandhurst, Chevron Cedar, Kingsbury, Barrington, Bosworth and all double GRP doors	55.5 + 10	2078	41.00



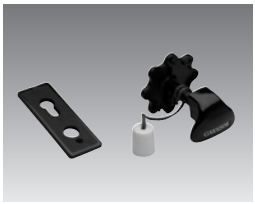
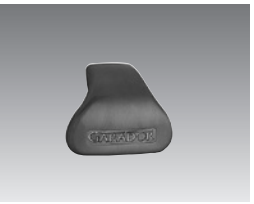

GARADOR Up & Over Doors (2002 - current)

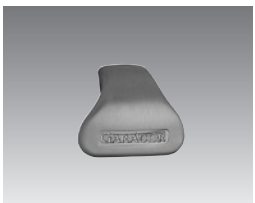
Handles, Lock Assembly and Keys

				
Article	Standard Black Handle All steel doors. 2002 - current	Standard Black Handle (adjustable and fascia) All timber and GRP doors. 2002 - current	Brass Effect Handle For up & over doors 2002 - current	Chrome Effect Handle For up & over doors 2002 - current
Ref. No.	550	232	5072	5073
Price £	13.00	27.00	30.00	30.00

				
Article	White Effect Handle For up & over doors 2002 - current	Brushed Steel Effect Handle For up & over doors 2002 - current	Brass Fascia Plate For up & over doors 2002 - current	Chrome Fascia Plate For up & over doors 2002 - current
Ref. No.	5071	6460	3161	3162
Price £	30.00	28.00	8.00	8.00

		
Article	White Fascia Plate For up & over doors 2002 - current	Brushed Steel Fascia Plate For up & over doors 2002 - current
Ref. No.	3160	7648
Price £	8.00	8.00

Weather seal components

				
Article	Bottom Weather Seal Length 2405 mm (15mm profile)	Bottom Weather Seal Length 3000 mm (15mm profile)	Glue Down Rubber Weatherseal Approx 2.5 m length	Brushstrip Approx 2.5m length
Ref. No.	1192	1193	1837	1196
Price £	31.00	35.00	32.00	30.00

GARADOR *Up & Over Doors (Pre 2002)*

Pre-2002 Spring Ref No. Conversion Chart

C Type overhead spring box fitted to a timber frame - Ref. No.	Spring No.
4739	S1703001-3-1
4740	S1703001-3-2
4741	S1703001-3-3
4742	S1703001-3-4
4743	S1703001-3-6
4744	S1703001-3-8
4745	S1703001-3-9
4746	S1703001-3-10
4747	S1703001-3-11

C Type side extension spring fitted to a timber frame - Ref. No.	Spring No.
4733	G230-18-1
4734	G230-18-2
4735	G230-18-3
4736	G230-18-4
4737	G230-18-5
4738	G230-18-6

F type & MK 4 spring - Ref. No.	Spring No.
2149	S4-401
2150	S4-402
2151	S4-404
2152	S4-405
2153	S4-407

R, FR & DR spring - Ref. No.	Spring No.
4763	108-901
4764	108-903
4765	108-905
4766	108-907
4767	108-909
4768	108-911
4769	108-913
4770	108-915
4774	108-921
4775	108-923
4776	108-925
4777	108-927

DC Type spring - Ref. No.	Spring No.
4748	108-701
4749	108-703
4750	108-705
4751	108-707
4752	108-709
4753	108-711
4754	108-713
4755	108-721
4756	108-723
4757	108-725
4758	108-727

Canopy Doors

Mark 3C Springs Suitable for Overhead Spring Box fitted to a timber frame - Steel Panel Doors

Used on all Canopy doors pre 1999. Springs priced and supplied individually. However, it is always recommended that both springs are replaced at the same time.



For price, please see page 19

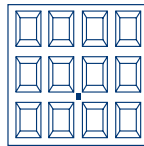

Georgian/Georgian Elite

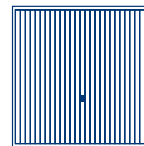

Carlton/Carlton Elite



Salisbury/Salisbury Elite

	Spring box number	Spring box spring	No. of bands & Colour	Spring box number	Spring box spring	No. of bands & Colour	Spring box number	Spring box spring	No. of bands & Colour
6'6"x6'3"	-	-	-	PN58	4739	1 x Silver	-	-	-
6'6"x6'6"	PN167	4743	None	PN58	4739	1 x Silver	-	-	-
6'6"x7'0"	PN167	4743	None	PN58	4739	1 x Silver	-	-	-
7'0"x6'3"	-	-	-	N/A	N/A	N/A	-	-	-
7'0"x6'6"	PN57/1	4740	1 x Blue	PN58	4739	1 x Silver	PN55/2	4742	3 x Blue
7'0"x7'0"	PN150	4746	None	PN55/2	4742	3 x Blue	PN155	4747	1 x Orange
7'3 1/2"x6'4"	-	-	-	PN57/1	4740	1 x Blue	-	-	-
7'5"x6'3"	-	-	-	-	-	-	-	-	-
7'5"x6'6"	PN55/2	4742	3 x Blue	PN57/1	4740	1 x Blue	PN155	4747	1 x Orange
7'5"x7'0"	PN108	4745	2 x Orange	PN150	4746	None	PN108	4745	2 x Orange
7'6"x6'6"	PN55/2	4742	3 x Blue	PN57/1	4740	1 x Blue	PN155	4747	1 x Orange
7'6"x7'0"	N/A	N/A	N/A	N/A	N/A	N/A	N/A	N/A	N/A
7'8 1/2"x6'3"	-	-	-	N/A	N/A	N/A	-	-	-
7'8 1/2"x6'6 3/4"	PN150	4746	None	PN55/2	4742	3 x Blue	-	-	-
7'8 1/2"x6'11 3/4"	N/A	N/A	N/A	PN155	4747	1 x Orange	-	-	-
8'0"x6'3"	-	-	-	N/A	N/A	N/A	-	-	-
8'0"x6'6"	PN150	4746	None	PN55/2	4742	3 x Blue	PN150	4746	None
8'0"x7'0"	PN108	4745	2 x Orange	PN155	4747	1 x Orange	PN155	4747	1 x Orange
8'2 1/2"x6'3"	-	-	-	N/A	N/A	N/A	-	-	-
8'2 1/2"x6'6 3/4"	-	-	-	PN150	4746	None	-	-	-
8'2 1/2"x6'11 3/4"	-	-	-	PN155	4747	1 x Orange	-	-	-

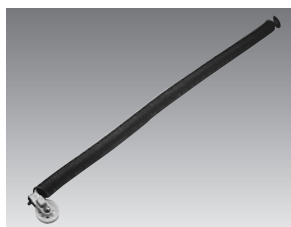

For price, please see page 19

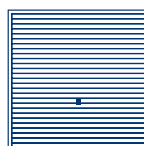

Horizon/Horizon Elite

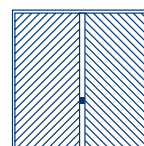

Chevron/Chevron Elite

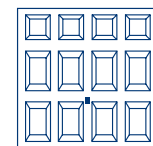

Beaumont/Beaumont Elite

	Spring box number	Spring box spring	No. of bands & Colour	Spring box number	Spring box spring	No. of bands & Colour	Spring box number	Spring box spring	No. of bands & Colour
6'6"x6'3"	PN58	4739	1 x Silver	-	-	-	-	-	-
6'6"x6'6"	PN58	4739	1 x Silver	PN167	4743	None	-	-	-
6'6"x7'0"	PN58	4739	1 x Silver	PN167	4743	None	-	-	-
7'0"x6'3"	N/A	N/A	N/A	-	-	-	-	-	-
7'0"x6'6"	PN58	4739	1 x Silver	PN57/1	4740	1 x Blue	4742	3 x Blue	
7'0"x7'0"	PN57/1	4740	1 x Blue	PN55/2	4742	3 x Blue	4747	1 x Orange	
7'3 1/2"x6'4"	PN56/1	4741	2 x Blue	-	-	-	-	-	-
7'5"x6'3"	N/A	N/A	N/A	-	-	-	-	-	-
7'5"x6'6"	PN56/1	4741	2 x Blue	PN55/2	4742	3 x Blue	4742	3 x Blue	

GARADOR Up & Over Doors (Pre 2002)

Canopy Doors

7'5"x7'0"	PN55/2	4742	3 x Blue	PN155	4747	1 x Orange	-	-	-
7'6"x6'6"	PN57/1	4740	1 x Blue	PN55/2	4742	3 x Blue	-	-	-
7'6"x7'0"	N/A	N/A	N/A	N/A	N/A	N/A	4747	1 x Orange	
7'8 1/2"x6'3"	N/A	N/A	N/A	-	-	-	-	-	-
7'8 1/2"x6'6 3/4"	PN115	4744	2 x Silver	PN55/2	4742	3 x Blue	-	-	-
7'8 1/2"x6'11 3/4"	PN55/2	4742	3 x Blue	PN155	4747	1 x Orange	-	-	-
8'0"x6'3"	N/A	N/A	N/A	-	-	-	-	-	-
8'0"x6'6"	PN115	4744	2 x Silver	-	-	-	-	-	-
8'0"x7'0"	PN150	4746	None	-	-	-	-	-	-
8'2 1/2"x6'3"	N/A	N/A	N/A	-	-	-	-	-	-
8'2 1/2"x6'6 3/4"	PN55/2	4742	3 x Blue	-	-	-	-	-	-
8'2 1/2"x6'11 3/4"	PN155	4747	1 x Orange	-	-	-	-	-	-

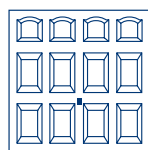

Cathedral/Cathedral Elite

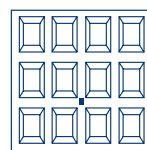

Parade-White/Brown

For price, please see page 19

	Spring box number	Spring box spring	No. of bands & Colour	Spring box number	Spring box spring	No. of bands & Colour
6'6"x6'3"	-	-	-	-	-	-
6'6"x6'6"	-	-	-	PN167	4743	None
6'6"x7'0"	-	-	-	-	-	-
7'0"x6'3"	-	-	-	-	-	-
7'0"x6'6"	PN55/2	4742	3 x Blue	PN57/1	4740	1 x Blue
7'0"x7'0"	PN155	4747	1 x Orange	PN155	4747	1 x Orange
7'3 1/2"x6'4"	-	-	-	-	-	-
7'5"x6'3"	-	-	-	-	-	-
7'5"x6'6"	PN55/2	4742	3 x Blue	PN155	4747	1 x Orange
7'5"x7'0"	-	-	-	PN155	4747	1 x Orange
7'6"x6'6"	-	-	-	N/A	N/A	N/A
7'6"x7'0"	PN155	4747	1 x Orange	N/A	N/A	N/A
7'8 1/2"x6'3"	-	-	-	-	-	-
7'8 1/2"x6'6 3/4"	-	-	-	-	-	-
7'8 1/2"x6'11 3/4"	-	-	-	-	-	-
8'0"x6'3"	-	-	-	-	-	-
8'0"x6'6"	-	-	-	PN155	4747	1 x Orange
8'0"x7'0"	-	-	-	PN108	4745	2 x Orange
8'2 1/2"x6'3"	-	-	-	-	-	-
8'2 1/2"x6'6 3/4"	-	-	-	-	-	-
8'2 1/2"x6'11 3/4"	-	-	-	-	-	-

Canopy Doors

Mark 3C Springs Suitable for Overhead Spring Box fitted to a timber frame - GRP Premier Panel Doors
Used on all Canopy doors pre 1999. Springs priced and supplied individually. However, it is always recommended that both springs are replaced at the same time.

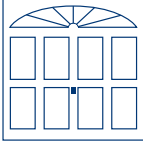
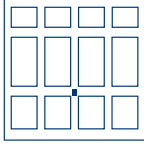
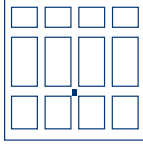
 <p>For price, please see page 19</p>	 <p>Stamford</p>			 <p>Arden</p>			 <p>Kenmore</p>			
	Spring box number	Spring box spring	No. of bands & Colour	Spring box number	Spring box spring	No. of bands & Colour	Spring box number	Spring box spring	No. of bands & Colour	
	7'0"x6'6"	N/A	N/A	N/A	PN55/2	4742	3 x Blue	PN55/2	4742	3 x Blue
	7'0"x7'0"	N/A	N/A	N/A	PN55/2	4742	3 x Blue	PN55/2	4742	3 x Blue
	7'5"x6'6"	N/A	N/A	N/A	PN155	4747	1 x Orange	PN155	4747	1 x Orange
7'6"x7'0"	N/A	N/A	N/A	PN155	4747	1 x Orange	PN155	4747	1 x Orange	

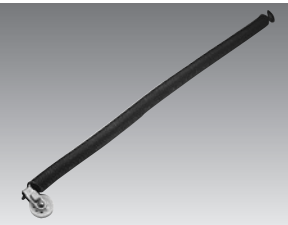
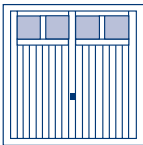
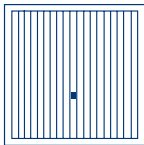
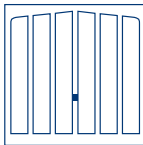
 <p>For price, please see page 19</p>	 <p>Derwent</p>			 <p>Swinton</p>			 <p>Clifton</p>			
	Spring box number	Spring box spring	No. of bands & Colour	Spring box number	Spring box spring	No. of bands & Colour	Spring box number	Spring box spring	No. of bands & Colour	
	7'0"x6'6"	N/A	N/A	N/A	PN55/2	4742	3 x Blue	PN55/2	4742	3 x Blue
	7'0"x7'0"	N/A	N/A	N/A	PN55/2	4742	3 x Blue	PN55/2	4742	3 x Blue
	7'5"x6'6"	N/A	N/A	N/A	PN155	4747	1 x Orange	PN155	4747	1 x Orange
7'6"x7'0"	N/A	N/A	N/A	PN155	4747	1 x Orange	PN155	4747	1 x Orange	

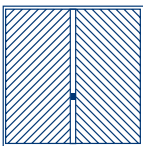
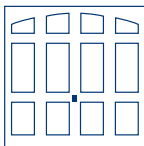
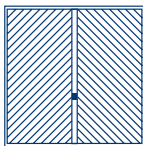
 <p>For price, please see page 19</p>	 <p>Oakham</p>			 <p>Woburn</p>			 <p>Wentwood</p>			
	Spring box number	Spring box spring	No. of bands & Colour	Spring box number	Spring box spring	No. of bands & Colour	Spring box number	Spring box spring	No. of bands & Colour	
	7'0"x6'6"	PN55/2	4742	3 x Blue	N/A	N/A	N/A	PN55/2	4742	3 x Blue
	7'0"x7'0"	PN55/2	4742	3 x Blue	N/A	N/A	N/A	PN155	4747	1 x Orange
	7'5"x6'6"	PN155	4747	1 x Orange	N/A	N/A	N/A	PN55/2	4742	3 x Blue
7'6"x7'0"	PN155	4747	1 x Orange	N/A	N/A	N/A	PN155	4747	1 x Orange	

GARADOR *Up & Over Doors (Pre 2002)*

Canopy Doors



For price, please see page 19

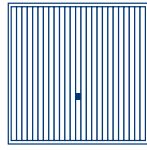

Sherwood

	Spring box number	Spring box spring	No. of bands & Colour
7'0"x6'6"	PN55/2	4742	3 x Blue
7'0"x7'0"	PN155	4747	1 x Orange
7'5"x6'6"	PN55/2	4742	3 x Blue
7'6"x7'0"	PN155	4747	1 x Orange

Canopy Doors

Mark 3C Springs Suitable for Overhead Spring Box fitted to a timber frame - Timber Panel Doors
Used on all Canopy doors pre 1999. Springs priced and supplied individually. However, it is always recommended that both springs are replaced at the same time.



For price, please see page 19	Chevron Cedar			Vertical Cedar			Sandhurst		
	Spring box number	Spring box spring	No. of bands & Colour	Spring box number	Spring box spring	No. of bands & Colour	Spring box number	Spring box spring	No. of bands & Colour
7'0"x6'6"	PN57/1	4740	1 x Blue	PN57/1	4740	1 x Blue	-	-	-
7'0"x7'0"	PN55/2	4742	3 x Blue	PN55/2	4742	3 x Blue	PN55/2	4742	3 x Blue
7'5"x6'6"	PN55/2	4742	3 x Blue	PN57/1	4740	1 x Blue	PN55/2	4742	3 x Blue
7'5"x7'0"	PN55/2	4742	3 x Blue	PN150	4746	None	PN55/2	4742	3 x Blue
7'6"x6'6"	PN55/2	4742	3 x Blue	PN55/2	4742	3 x Blue	PN55/2	4742	3 x Blue
7'6"x7'0"	-	-	-	PN55/2	4742	3 x Blue	-	-	-





For price, please see page 19	Cavendish			Wolsey			Seymour		
	Spring box number	Spring box spring	No. of bands & Colour	Spring box number	Spring box spring	No. of bands & Colour	Spring box number	Spring box spring	No. of bands & Colour
7'0"x6'6"	-	-	-	PN55/2	4742	3 x Blue	PN55/2	4742	3 x Blue
7'0"x7'0"	PN55/2	4742	3 x Blue	PN155	4747	1 x Orange	PN155	4747	1 x Orange
7'5"x6'6"	PN55/2	4742	3 x Blue	PN55/2	4742	3 x Blue	PN55/2	4742	3 x Blue
7'5"x7'0"	PN55/2	4742	3 x Blue	PN155	4747	1 x Orange	PN155	4747	1 x Orange
7'6"x6'6"	PN55/2	4742	3 x Blue	PN55/2	4742	3 x Blue	PN55/2	4742	3 x Blue
7'6"x7'0"	-	-	-	PN55/2	4742	3 x Blue	PN55/2	4742	3 x Blue



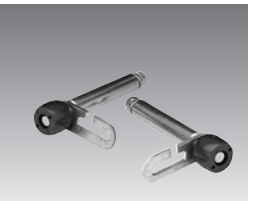

For price, please see page 19	Tudor			Horizontal Cedar		
	Spring box number	Spring box spring	No. of bands & Colour	Spring box number	Spring box spring	No. of bands & Colour
7'0"x6'6"	PN55/2	4742	3 x Blue	PN57/1	4740	1 x Blue
7'0"x7'0"	PN155	4747	1 x Orange	PN55/2	4742	3 x Blue
7'5"x6'6"	PN55/2	4742	3 x Blue	PN57/1	4740	1 x Blue
7'5"x7'0"	PN155	4747	1 x Orange	PN150	4746	None
7'6"x6'6"	PN55/2	4742	3 x Blue	-	-	-
7'6"x7'0"	PN55/2	4742	3 x Blue	-	-	-



GARADOR Up & Over Doors (Pre 2002)

Mark 3C Accessories for Overhead Spring Box Pre 1999 (canopy)

				
Article	Canopy Type Cables (Overhead Spring) 6'6" (1980 mm) wide door. Sold in pairs.	Canopy Type Cables (Overhead Spring) 7'0" (2135 mm) to 8'2 1/2" (2500 mm) wide door. Sold in pairs.	Canopy Type Cables (Overhead Spring) Belgravia doors only. Sold in pairs. Pre 1999	Rollers and spindles (pair) Overall length 94 mm. MK 3 C type only
Ref. No.	1154	1155	1156	1158
Price £	27.00	27.00	27.00	35.00

				
Article	Rollers and spindles (pair) Overall length 81 mm. C type only	C Type Overhead Spring For Box PN55/2 Pre 1999	C Type Overhead Spring For Box PN56/1 Pre 1999	C Type Overhead Spring For Box PN57/1 Pre 1999
Ref. No.	1159	4742	4741	4740
Price £	35.00	70.00	70.00	70.00

				
Article	C Type Overhead Spring For Box PN58 Pre 1999	C Type Overhead Spring For Box PN108 Pre 1999	C Type Overhead Spring For Box PN115 Pre 1999	C Type Overhead Spring For Box PN150 Pre 1999
Ref. No.	4739	4745	4744	4746
Price £	70.00	70.00	70.00	70.00

			
Article	C Type Overhead Spring For Box PN155 Pre 1999	C Type Overhead Spring For Box PN167 Pre 1999	C Type Link Arm Pre 1999
Ref. No.	4747	4743	(LH) 1202 , (RH) 1203
Price £	70.00	70.00	41.00

Framed Canopy Doors

Mark 4 / F-Type Springs - Steel Panel Doors

Used on all Framed Canopy doors pre 2002. For springs with flat fixing pins part 1197 is also required. Springs priced and supplied individually. However, it is always recommended that both springs are replaced at the same time.



For price, please see page 24

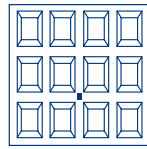

Georgian/Georgian Elite

Spring Type

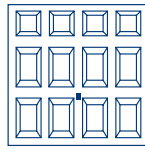

Beaumont/Beaumont Elite

Spring Type

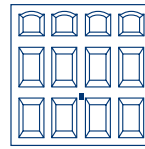

Cathedral/Cathedral Elite

Spring Type

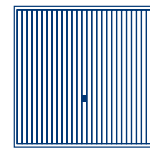

Carlton/Carlton Elite

Spring Type

	Georgian/Georgian Elite	Beaumont/Beaumont Elite	Cathedral/Cathedral Elite	Carlton/Carlton Elite
6'6" x 6'3"	-	-	-	2149
6'6" x 6'6"	2150	-	-	2149
6'6" x 7'0"	2151	-	-	2150
7'0" x 6'3"	-	-	-	2149
7'0" x 6'6"	2151	2150	2150	2149
7'0" x 7'0"	2153	2152	2152	2151
7'3 1/2" x 6'4"	-	-	-	2149
7'5" x 6'3"	-	-	-	2150
7'5" x 6'6"	2151	2151	2151	2150
7'5" x 7'0"	2153	2152	2152	2151
7'6" x 6'6"	2151	2152	2152	2150
7'6" x 7'0"	2153	2153	2153	2152
7'8 1/2" x 6'3"	-	-	-	2150
7'8 1/2" x 6'6 3/4"	2152	2152	2152	2150
7'8 1/2" x 6'11 3/4"	2153	2152	2152	2152
8'0" x 6'3"	-	-	-	2151
8'0" x 6'6"	2152	2152	2152	2151
8'0" x 7'0"	2153	2153	2153	2152
8'2 1/2" x 6'3"	-	-	-	2151
8'2 1/2" x 6'6 3/4"	-	-	-	2151
8'2 1/2" x 6'11 3/4"	-	-	-	2152

GARADOR Up & Over Doors (Pre 2002)

Framed Canopy Doors

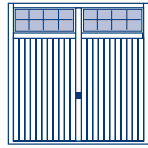

Salisbury/Salisbury Elite

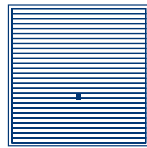

Horizon/Horizon Elite

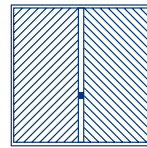

Chevron/Chevron Elite

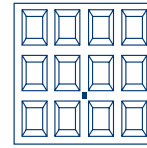

Parade-White/ Brown

For price, please see page 24

Spring Type

Spring Type

Spring Type

Spring Type

6'6"x6'3"	-	2149	-	-
6'6"x6'6"	-	2149	2149	-
6'6"x7'0"	-	2150	2150	-
7'0"x6'3"	-	2149	-	-
7'0"x6'6"	2151	2149	2149	2151
7'0"x7'0"	2152	2150	2150	2152
7'3 1/2"x6'4"	-	2149	-	-
7'5"x6'3"	-	2149	-	-
7'5"x6'6"	2152	2149	2150	2152
7'5"x7'0"	2153	2151	2151	2151
7'6"x6'6"	2152	2150	2150	2151
7'6"x7'0"	2153	2151	2151	2152
7'8 1/2"x6'3"	-	2150	-	-
7'8 1/2"x6'6 3/4"	-	2150	2151	-
7'8 1/2"x6'11 3/4"	-	2152	2152	-
8'0"x6'3"	-	2150	-	-
8'0"x6'6"	2153	2150	-	2151
8'0"x7'0"	2153	2152	-	2152
8'2 1/2"x6'3"	-	2150	-	-
8'2 1/2"x6'6 3/4"	-	2150	-	2152
8'2 1/2"x6'11 3/4"	-	2152	-	2153

Framed Canopy Doors

Mark 4 / F-Type Spring - GRP Premier Panel Doors

Used on all Framed Canopy doors pre 2002. For springs with flat fixing pins part S4-6 is also required. Springs priced and supplied individually. However, it is always recommended that both springs are replaced at the same time.



For price, please see page 24

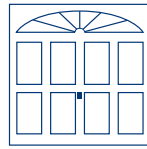

Stamford

Spring Type

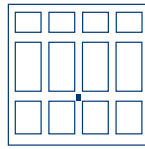

Arden

Spring Type

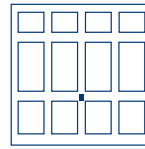

Kenmore

Spring Type

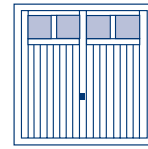

Derwent

Spring Type

7'0"x6'6"	2151	2152	2152	2152
7'0"x7'0"	2151	2152	2152	2152
7'5"x6'6"	2151	2152	2152	2152
7'6"x7'0"	2151	2152	2152	2152

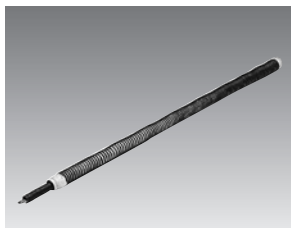

For price, please see page 24

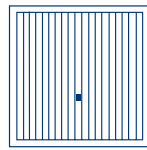

Swinton

Spring Type

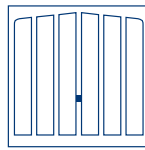

Clifton

Spring Type

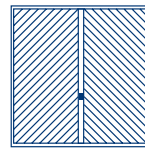

Oakham

Spring Type

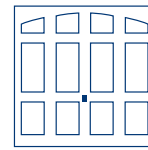

Woburn

Spring Type

7'0"x6'6"	2151	2152	2152	2152
7'0"x7'0"	2151	2152	2152	2152
7'5"x6'6"	2151	2152	2152	2152
7'6"x7'0"	2151	2152	2152	2152

GARADOR Up & Over Doors (Pre 2002)

Framed Canopy Doors

Mark 4 / F-Type Springs - Timber Panel Doors

Used on all Framed Canopy doors pre 2002. For springs with flat fixing pins part S4-6 is also required. Springs priced and supplied individually. However, it is always recommended that both springs are replaced at the same time.

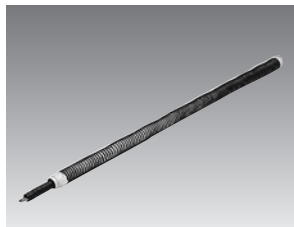

For price, please see page 24

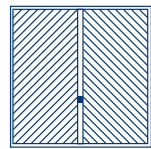

Chevron Cedar

Spring Type

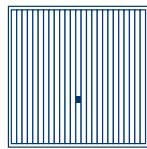

Vertical Cedar

Spring Type

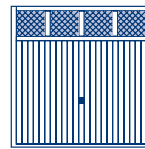

Sandhurst

Spring Type

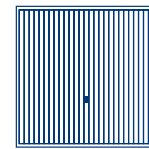

Cavendish

Spring Type

7'0"x6'6"	2150	2149	2151	2151
7'0"x7'0"	2150	2150	2152	2152
7'5"x6'6"	2150	2150	2151	2151
7'5"x7'0"	2151	2150	2152	2152
7'6"x6'6"	2150	2150	-	-
7'6"x7'0"	2151	2150	-	-



For price, please see page 24

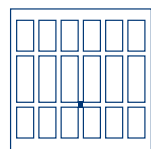

Wolsey

Spring Type

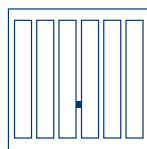

Seymour

Spring Type

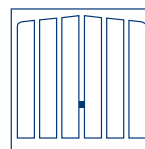

Tudor

Spring Type

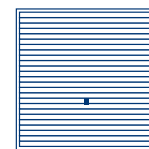









Horizontal Cedar

Spring Type

7'0"x6'6"	2150	2150	2150	2150
7'0"x7'0"	2151	2151	2151	2151
7'5"x6'6"	2151	2151	2151	2151
7'5"x7'0"	2152	2152	2152	2152
7'6"x6'6"	2151	2151	2151	-
7'6"x7'0"	2152	2152	2152	-

Accessories for Mark 4 / F-Type Doors (canopy)

				
Article	F Type Roller Spindle Assembly (Pair) E clip supplied	Pre 2002 Framed Canopy Door Spring	Pre 2002 Framed Canopy Door Spring	Pre 2002 Framed Canopy Door Spring
Ref. No.	1160	2149	2150	2151
Price £	27.00	98.00	120.00	120.00
				
Article	Pre 2002 Framed Canopy Door Spring	Pre 2002 Framed Canopy Door Spring	Framed Canopy Link Arm Supplied with pin spacer and washer. Pre March 2002	Framed Canopy Spring Anchor Top Pin Pre March 2002
Ref. No.	2152	2153	(LH) 1199, (RH) 1200	1197
Price £	120.00	130.00	41.00	15.00

GARADOR Up & Over Doors (Pre 2002)

Canopy Doors

C Type Side Extension Spring fitted to a timber frame - Steel Panel Doors

Used on all Canopy doors between 1999 and 2002. Springs priced and supplied individually. However, it is always recommended that both springs are replaced at the same time.



For price, please see page 29

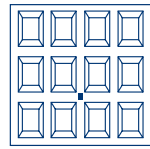

Georgian/Georgian Elite

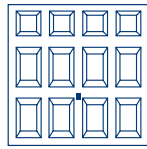

Beaumont/Beaumont Elite

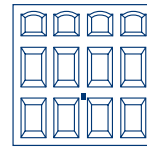

Cathedral/Cathedral Elite

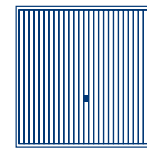

Carlton/Carlton Elite

	Georgian/Georgian Elite		Beaumont/Beaumont Elite		Cathedral/Cathedral Elite		Carlton/Carlton Elite	
	Spring box number	No. of bands & Colour	Spring box number	No. of bands & Colour	Spring box number	No. of bands & Colour	Spring box number	No. of bands & Colour
6'6"x6'3"	-	-	-	-	-	-	4733	White
6'6"x6'6"	4735	Green	-	-	-	-	4733	White
6'6"x7'0"	4737	Red	-	-	-	-	4734	2 x White
7'0"x6'3"	-	-	-	-	-	-	4733	White
7'0"x6'6"	4735	Green	4735	Green	4735	Green	4733	White
7'0"x7'0"	4737	Red	4736	2 x Green	4736	2 x Green	4734	2 x White
7'3 1/2"x6'4"	-	-	-	-	-	-	4734	2 x White
7'5"x6'3"	-	-	-	-	-	-	4734	2 x White
7'5"x6'6"	4736	2 x Green	4735	Green	4735	Green	4734	2 x White
7'5"x7'0"	4737	Red	4737	Red	4737	Red	4735	Green
7'6"x6'6"	4736	2 x Green	4736	2 x Green	4736	2 x Green	4735	Green
7'6"x7'0"	4737	Red	4737	Red	4737	Red	4736	2 x Green
7'8 1/2"x6'3"	-	-	-	-	-	-	4733	White
7'8 1/2"x6'6 3/4"	4736	2 x Green	4736	2 x Green	4736	2 x Green	4734	2 x White
7'8 1/2"x6'11 3/4"	4737	Red	4736	2 x Green	4736	2 x Green	4735	Green
8'0"x6'3"	-	-	-	-	-	-	4735	Green
8'0"x6'6"	4738	2 x Red	4736	2 x Green	4736	2 x Green	4736	2 x Green
8'0"x7'0"	4738	2 x Red	4737	Red	4737	Red	4736	2 x Green
8'2 1/2"x6'3"	-	-	-	-	-	-	4735	Green
8'2 1/2"x6'6 3/4"	-	-	-	-	-	-	4736	2 x Green
8'2 1/2"x6'11 3/4"	-	-	-	-	-	-	4736	2 x Green

Canopy Doors



For price, please see page 29

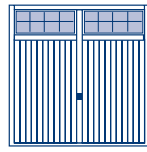

Salisbury/Salisbury Elite

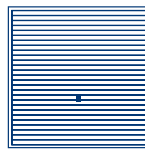

Horizon/Horizon Elite

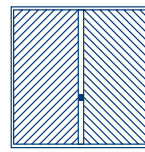

Chevron/Chevron Elite

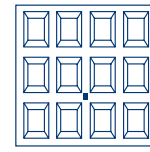

Parade-White/Brown

	Salisbury/Salisbury Elite		Horizon/Horizon Elite		Chevron/Chevron Elite		Parade-White/Brown	
	Spring box number	No. of bands & Colour	Spring box number	No. of bands & Colour	Spring box number	No. of bands & Colour	Spring box number	No. of bands & Colour
6'6"x6'3"	-	-	4733	White	-	-	-	-
6'6"x6'6"	-	-	4733	White	4733	White	-	-
6'6"x7'0"	-	-	4734	2 x White	4734	2 x White	-	-
7'0"x6'3"	-	-	4733	White	-	-	-	-
7'0"x6'6"	4735	Green	4733	White	4734	2 x White	4735	Green
7'0"x7'0"	4737	Red	4734	2 x White	4734	2 x White	4736	2 x Green
7'3 1/2"x6'4"	-	-	4733	White	-	-	-	-
7'5"x6'3"	-	-	4733	White	-	-	-	-
7'5"x6'6"	4737	Red	4733	White	4735	Green	4735	Green
7'5"x7'0"	4737	Red	4734	2 x White	4738	2 x Red	4737	Red
7'6"x6'6"	4737	Red	4735	Green	4736	2 x Green	4736	2 x Green
7'6"x7'0"	4737	Red	4735	Green	4738	2 x Red	4737	Red
7'8 1/2"x6'3"	-	-	4733	White	-	-	-	-
7'8 1/2"x6'6 3/4"	-	-	4734	2 x White	4736	2 x Green	4736	2 x Green
7'8 1/2"x6'11 3/4"	-	-	4735	Green	4738	2 x Red	4736	2 x Green
8'0"x6'3"	-	-	4735	Green	-	-	-	-
8'0"x6'6"	4737	Red	4735	Green	-	-	4736	2 x Green
8'0"x7'0"	4738	2 x Red	4735	Green	-	-	4737	Red
8'2 1/2"x6'3"	-	-	4735	Green	-	-	-	-
8'2 1/2"x6'6 3/4"	-	-	4735	Green	-	-	-	-
8'2 1/2"x6'11 3/4"	-	-	4736	2 x Green	-	-	-	-

GARADOR Up & Over Doors (Pre 2002)

Canopy Doors

C Type Side Extension Spring fitted to a timber frame - GRP Premier Panel Doors

Used on all Canopy doors between 1999 and 2002. Springs priced and supplied individually. However, it is always recommended that both springs are replaced at the same time.



For price, please see page 29

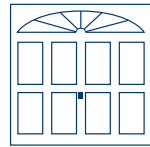

Stamford

Spring box number	No. of bands & Colour
-------------------	-----------------------

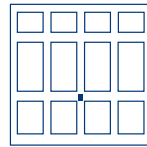

Arden

Spring box number	No. of bands & Colour
-------------------	-----------------------

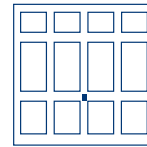

Kenmore

Spring box number	No. of bands & Colour
-------------------	-----------------------

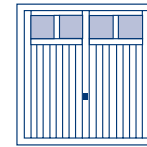

Derwent

Spring box number	No. of bands & Colour
-------------------	-----------------------

7'0"x6'6"	4734	2 x White	4734	2 x White	4734	2 x White	4734	2 x White
7'0"x7'0"	4735	Green	4735	Green	4735	Green	4735	Green
7'5"x6'6"	4734	2 x White	4734	2 x White	4734	2 x White	4734	2 x White
7'6"x7'0"	4735	Green	4735	Green	4735	Green	4735	Green

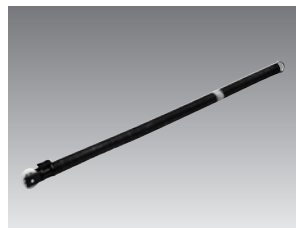

For price, please see page 29

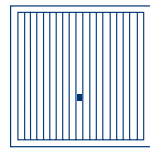

Swinton

Spring box number	No. of bands & Colour
-------------------	-----------------------

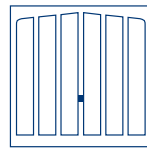

Clifton

Spring box number	No. of bands & Colour
-------------------	-----------------------

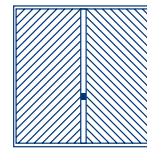

Oakham

Spring box number	No. of bands & Colour
-------------------	-----------------------

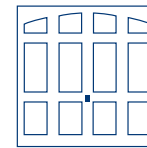

Woburn

Spring box number	No. of bands & Colour
-------------------	-----------------------

7'0"x6'6"	4734	2 x White	4734	2 x White	4734	2 x White	4734	2 x White
7'0"x7'0"	4735	Green	4735	Green	4735	Green	4735	Green
7'5"x6'6"	4734	2 x White	4734	2 x White	4734	2 x White	4734	2 x White
7'6"x7'0"	4735	Green	4735	Green	4735	Green	4735	Green

Canopy Doors

C Type Side Extension Spring fitted to a timber frame - Timber Panel Doors

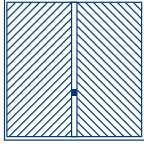
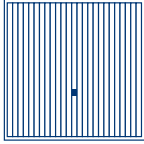
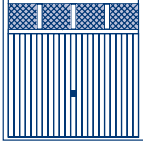
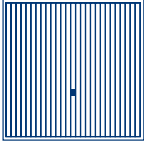

Used on all Canopy doors between 1999 and 2002. Springs priced and supplied individually. However, it is always recommended that both springs are replaced at the same time.





 <p>For price, please see page 29</p>	 <p>Chevron Cedar</p>	 <p>Vertical Cedar</p>	 <p>Sandhurst</p>	 <p>Cavendish</p>																																																							
	<table border="1"> <thead> <tr> <th>Spring box number</th> <th>No. of bands & Colour</th> </tr> </thead> <tbody> <tr> <td>4734</td> <td>2 x White</td> </tr> <tr> <td>4735</td> <td>Green</td> </tr> <tr> <td>4735</td> <td>Green</td> </tr> <tr> <td>4735</td> <td>Green</td> </tr> <tr> <td>4735</td> <td>Green</td> </tr> <tr> <td>-</td> <td>-</td> </tr> </tbody> </table>	Spring box number	No. of bands & Colour	4734	2 x White	4735	Green	4735	Green	4735	Green	4735	Green	-	-	<table border="1"> <thead> <tr> <th>Spring box number</th> <th>No. of bands & Colour</th> </tr> </thead> <tbody> <tr> <td>4733</td> <td>White</td> </tr> <tr> <td>4734</td> <td>2 x White</td> </tr> <tr> <td>4733</td> <td>White</td> </tr> <tr> <td>4734</td> <td>2 x White</td> </tr> <tr> <td>4734</td> <td>2 x White</td> </tr> <tr> <td>4734</td> <td>2 x White</td> </tr> </tbody> </table>	Spring box number	No. of bands & Colour	4733	White	4734	2 x White	4733	White	4734	2 x White	4734	2 x White	4734	2 x White	<table border="1"> <thead> <tr> <th>Spring box number</th> <th>No. of bands & Colour</th> </tr> </thead> <tbody> <tr> <td>-</td> <td>-</td> </tr> <tr> <td>4736</td> <td>2 x Green</td> </tr> <tr> <td>4735</td> <td>Green</td> </tr> <tr> <td>4736</td> <td>2 x Green</td> </tr> <tr> <td>4735</td> <td>Green</td> </tr> <tr> <td>-</td> <td>-</td> </tr> </tbody> </table>	Spring box number	No. of bands & Colour	-	-	4736	2 x Green	4735	Green	4736	2 x Green	4735	Green	-	-	<table border="1"> <thead> <tr> <th>Spring box number</th> <th>No. of bands & Colour</th> </tr> </thead> <tbody> <tr> <td>-</td> <td>-</td> </tr> <tr> <td>4736</td> <td>2 x Green</td> </tr> <tr> <td>4735</td> <td>Green</td> </tr> <tr> <td>4736</td> <td>2 x Green</td> </tr> <tr> <td>4735</td> <td>Green</td> </tr> <tr> <td>-</td> <td>-</td> </tr> </tbody> </table>	Spring box number	No. of bands & Colour	-	-	4736	2 x Green	4735	Green	4736	2 x Green	4735	Green	-
Spring box number	No. of bands & Colour																																																										
4734	2 x White																																																										
4735	Green																																																										
4735	Green																																																										
4735	Green																																																										
4735	Green																																																										
-	-																																																										
Spring box number	No. of bands & Colour																																																										
4733	White																																																										
4734	2 x White																																																										
4733	White																																																										
4734	2 x White																																																										
4734	2 x White																																																										
4734	2 x White																																																										
Spring box number	No. of bands & Colour																																																										
-	-																																																										
4736	2 x Green																																																										
4735	Green																																																										
4736	2 x Green																																																										
4735	Green																																																										
-	-																																																										
Spring box number	No. of bands & Colour																																																										
-	-																																																										
4736	2 x Green																																																										
4735	Green																																																										
4736	2 x Green																																																										
4735	Green																																																										
-	-																																																										

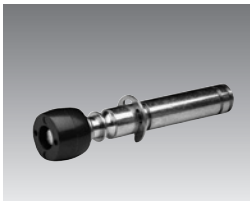

 <p>For price, please see page 29</p>	 <p>Wolsey</p>	 <p>Seymour</p>	 <p>Tudor</p>	 <p>Horizontal Cedar</p>																																																							
	<table border="1"> <thead> <tr> <th>Spring box number</th> <th>No. of bands & Colour</th> </tr> </thead> <tbody> <tr> <td>4735</td> <td>Green</td> </tr> <tr> <td>4735</td> <td>Green</td> </tr> <tr> <td>4735</td> <td>Green</td> </tr> <tr> <td>4736</td> <td>2 x Green</td> </tr> <tr> <td>4735</td> <td>Green</td> </tr> <tr> <td>4736</td> <td>2 x Green</td> </tr> </tbody> </table>	Spring box number	No. of bands & Colour	4735	Green	4735	Green	4735	Green	4736	2 x Green	4735	Green	4736	2 x Green	<table border="1"> <thead> <tr> <th>Spring box number</th> <th>No. of bands & Colour</th> </tr> </thead> <tbody> <tr> <td>4735</td> <td>Green</td> </tr> <tr> <td>4735</td> <td>Green</td> </tr> <tr> <td>4735</td> <td>Green</td> </tr> <tr> <td>4736</td> <td>2 x Green</td> </tr> <tr> <td>4735</td> <td>Green</td> </tr> <tr> <td>4736</td> <td>2 x Green</td> </tr> </tbody> </table>	Spring box number	No. of bands & Colour	4735	Green	4735	Green	4735	Green	4736	2 x Green	4735	Green	4736	2 x Green	<table border="1"> <thead> <tr> <th>Spring box number</th> <th>No. of bands & Colour</th> </tr> </thead> <tbody> <tr> <td>4735</td> <td>Green</td> </tr> <tr> <td>4735</td> <td>Green</td> </tr> <tr> <td>4735</td> <td>Green</td> </tr> <tr> <td>4736</td> <td>2 x Green</td> </tr> <tr> <td>4735</td> <td>Green</td> </tr> <tr> <td>4736</td> <td>2 x Green</td> </tr> </tbody> </table>	Spring box number	No. of bands & Colour	4735	Green	4735	Green	4735	Green	4736	2 x Green	4735	Green	4736	2 x Green	<table border="1"> <thead> <tr> <th>Spring box number</th> <th>No. of bands & Colour</th> </tr> </thead> <tbody> <tr> <td>N/A</td> <td>N/A</td> </tr> <tr> <td>N/A</td> <td>N/A</td> </tr> <tr> <td>N/A</td> <td>N/A</td> </tr> <tr> <td>N/A</td> <td>N/A</td> </tr> <tr> <td>-</td> <td>-</td> </tr> <tr> <td>-</td> <td>-</td> </tr> </tbody> </table>	Spring box number	No. of bands & Colour	N/A	N/A	N/A	N/A	N/A	N/A	N/A	N/A	-	-	-
Spring box number	No. of bands & Colour																																																										
4735	Green																																																										
4735	Green																																																										
4735	Green																																																										
4736	2 x Green																																																										
4735	Green																																																										
4736	2 x Green																																																										
Spring box number	No. of bands & Colour																																																										
4735	Green																																																										
4735	Green																																																										
4735	Green																																																										
4736	2 x Green																																																										
4735	Green																																																										
4736	2 x Green																																																										
Spring box number	No. of bands & Colour																																																										
4735	Green																																																										
4735	Green																																																										
4735	Green																																																										
4736	2 x Green																																																										
4735	Green																																																										
4736	2 x Green																																																										
Spring box number	No. of bands & Colour																																																										
N/A	N/A																																																										
N/A	N/A																																																										
N/A	N/A																																																										
N/A	N/A																																																										
-	-																																																										
-	-																																																										

GARADOR Up & Over Doors (Pre 2002)

Accessories for doors with C Type Side Extension Springs 1999 - 2002 (canopy)

				
Article	Side Extension Spring Cables Sold in pairs. 1999 - 2002	Roller and Spindle Assembly (Pair) Side extension spring	Wall Bracket Assembly For canopy doors. 1999 - 2002	C Type Side Extension Spring 1999 - 2002
Ref. No.	1157	1161	(LH) 1206, (RH) 1207	4733
Price £	27.00 (per pair)	35.00	24.00	63.00

				
Article	C Type Side Extension Spring 1999 - 2002	C Type Side Extension Spring 1999 - 2002	C Type Side Extension Spring 1999 - 2002	C Type Side Extension Spring 1999 - 2002
Ref. No.	4734	4735	4736	4737
Price £	63.00	63.00	63.00	63.00

				
Article	C Type Side Extension Spring 1999 - 2002	Spring Anchor Bracket 1999 - 2002	S Hook For canopy doors. 1999 - 2002	Canopy Type Side Unit Cover 1999 - 2002
Ref. No.	4738	1208	1194	1195
Price £	63.00	10.00	9.00	21.00

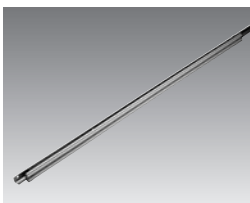
		
Article	Right Link Arm (bare) For canopy doors. 1999 - 2002	Track and Slider Assembly 1999 - 2002
Ref. No.	(LH) 1204, (RH) 1205	(LH) 1209, (RH) 1210
Price £	27.00	21.00

Framed Retractable and Retractable Doors

Framed Retractable and Retractable and Double Retractable Spring - Steel Panel Doors

Used on all FR and R type doors pre 2002 (595 mm long). Springs priced and supplied individually. However, it is always recommended that both springs are replaced at the same time.



For price, please see
pages 34 and 35

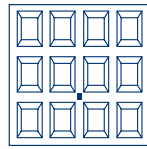

Georgian/Georgian Elite

Spring Type

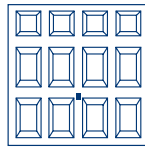

Beaumont/Beaumont
Elite

Spring Type

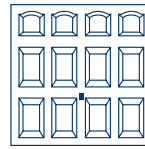

Cathedral/Cathedral
Elite

Spring Type

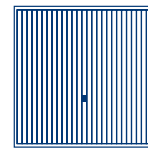

Carlton/Carlton Elite

Spring Type

	Georgian/Georgian Elite	Beaumont/Beaumont Elite	Cathedral/Cathedral Elite	Carlton/Carlton Elite
6'6" x 6'3"	-	-	-	N/A
6'6" x 6'6"	4763	-	-	4776
6'6" x 7'0"	4765	-	-	4777
7'0" x 6'3"	-	-	-	N/A
7'0" x 6'6"	4764	4763	4763	4776
7'0" x 7'0"	4765	4764	4764	4763
7'3 1/2" x 6'4"	-	-	-	N/A
7'5" x 6'3"	-	-	-	N/A
7'5" x 6'6"	4764	4764	4764	4777
7'5" x 7'0"	4766	4765	4765	4766
7'6" x 6'6"	4766	4764	4764	4764
7'6" x 7'0"	4768	4765	4765	4766
7'8 1/2" x 6'3"	-	-	-	N/A
7'8 1/2" x 6'6 3/4"	4768	4766	4766	4764
7'8 1/2" x 6'11 3/4"	4769	4768	4768	4764
8'0" x 6'3"	-	-	-	N/A
8'0" x 6'6"	4768	4766	4766	4764
8'0" x 7'0"	4769	4768	4768	4767
8'2 1/2" x 6'3"	-	-	-	N/A
8'2 1/2" x 6'6 3/4"	-	-	-	-
8'2 1/2" x 6'11 3/4"	-	-	-	-
9'0" x 6'6"	4775	-	-	4769
9'0" x 7'0"	4776	-	-	4769
10'0" x 6'6"	4776	-	-	4774
10'0" x 7'0"	4776	-	-	4775
11'0" x 6'6"	4777	-	-	4775
11'0" x 7'0"	4777	-	-	4776
12'0" x 6'6"	4763	-	-	4776
12'0" x 7'0"	4764	-	-	4777
13'0" x 6'6"	4768	-	-	4764
13'0" x 7'0"	4769	-	-	4766
14'0" x 6'6"	4769	-	-	4766
14'0" x 7'0"	4770	-	-	4768
15'0" x 6'6"	-	-	-	4768
15'0" x 7'0"	-	-	-	4769
16'0" x 6'6"	-	-	-	4769
16'0" x 7'0"	-	-	-	4770

GARADOR Up & Over Doors (Pre 2002)

Retractable Doors



For price, please see
pages 34 and 35



Salisbury/Salisbury Elite

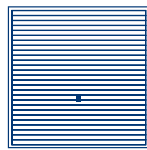

Horizon/Horizon Elite

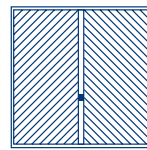

Chevron/Chevron Elite

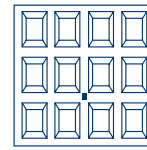

Parade-White/Brown



	Spring Type	Spring Type	Spring Type	Spring Type
6'6"x6'3"	-	N/A	-	-
6'6"x6'6"	-	4775	4776	-
6'6"x7'0"	-	4776	4765	-
7'0"x6'3"	-	N/A	-	-
7'0"x6'6"	4764	4775	4777	4763
7'0"x7'0"	4766	4777	4764	4764
7'3 1/2"x6'4"	-	N/A	-	-
7'5"x6'3"	-	N/A	-	-
7'5"x6'6"	4768	4776	4776	4764
7'5"x7'0"	4766	4763	4763	4765
7'6"x6'6"	4766	4776	4766	4764
7'6"x7'0"	4766	4763	4768	4764
7'8 1/2"x6'3"	-	N/A	-	-
7'8 1/2"x6'6 3/4"	-	4763	4764	-
7'8 1/2"x6'11 3/4"	-	4764	4766	-
8'0"x6'3"	-	N/A	-	-
8'0"x6'6"	4766	4763	-	4766
8'0"x7'0"	4768	4764	-	4768
8'2 1/2"x6'3"	-	N/A	-	-
8'2 1/2"x6'6 3/4"	-	-	-	4766
8'2 1/2"x6'11 3/4"	-	-	-	4768
9'0"x6'6"	-	4769	-	-
9'0"x7'0"	-	4769	-	-
10'0"x6'6"	-	4769	-	-
10'0"x7'0"	-	4774	-	-
11'0"x6'6"	-	4774	-	-
11'0"x7'0"	-	4775	-	-
12'0"x6'6"	-	4775	-	-
12'0"x7'0"	-	4776	-	-
13'0"x6'6"	-	4777	-	-
13'0"x7'0"	-	4763	-	-
14'0"x6'6"	-	4764	-	4769
14'0"x7'0"	-	4766	-	4770
15'0"x6'6"	-	4766	-	-
15'0"x7'0"	-	4766	-	-
16'0"x6'6"	-	4769	-	-
16'0"x7'0"	-	4770	-	-

Last three digits identification stamped onto alloy tag and or spring eye.

Framed Retractable and Retractable Doors

Framed Retractable and Retractable and Double Retractable Type Spring - GRP Premier Panel Doors

Used on all FR and R type doors pre 2002.

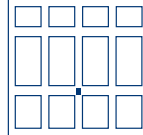
 <p>For price, please see pages 34 and 35</p>	 <p>Stamford</p> <p>Spring Type</p>	 <p>Arden</p> <p>Spring Type</p>	 <p>Kenmore</p> <p>Spring Type</p>	 <p>Derwent</p> <p>Spring Type</p>
	7'0"x6'6"	4766	4766	4766
7'0"x7'0"	4766	4766	4766	4766
7'5"x6'6"	4766	4766	4766	4766
7'6"x7'0"	4766	4766	4766	4766
9'0"x6'6"	4769	4769	4769	-
9'0"x7'0"	4769	4769	4769	-
10'0"x6'6"	4769	4769	4769	-
10'0"x7'0"	4769	4774	4774	-
11'0"x6'6"	-	4774	4774	-
11'0"x7'0"	-	4775	4775	-
12'0"x6'6"	-	4776	4776	-
12'0"x7'0"	-	4776	4776	-
14'0"x6'6"	4763	4763	4763	-

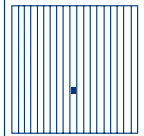
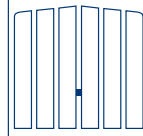
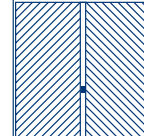
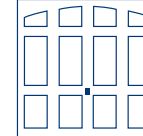
 <p>For price, please see pages 34 and 35</p>	 <p>Swinton</p> <p>Spring Type</p>	 <p>Clifton</p> <p>Spring Type</p>	 <p>Oakham</p> <p>Spring Type</p>	 <p>Woburn</p> <p>Spring Type</p>
	7'0"x6'6"	4766	4766	4766
7'0"x7'0"	4766	4766	4766	4766
7'5"x6'6"	4766	4766	4766	4766
7'6"x7'0"	4766	4766	4766	4766
9'0"x6'6"	-	4769	-	-
9'0"x7'0"	-	4769	-	-
10'0"x6'6"	-	4769	-	-
10'0"x7'0"	-	4774	-	-
11'0"x6'6"	-	-	-	-
11'0"x7'0"	-	-	-	-
12'0"x6'6"	-	-	-	-
12'0"x7'0"	-	-	-	-
14'0"x6'6"	-	4763	-	-

GARADOR Up & Over Doors (Pre 2002)

Framed Retractable and Retractable Doors

Framed Retractable and Retractable and Double Retractable Type Spring - Timber Panel Doors

Used on all FR and R type doors pre 2002.



For price, please see pages 34 and 35

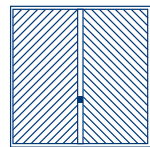

Chevron Cedar

Spring Type

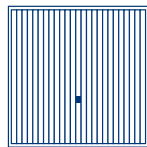

Vertical Cedar

Spring Type

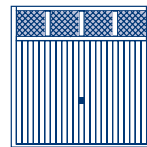

Sandhurst

Spring Type

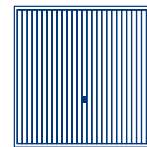

Cavendish

Spring Type

7'0"x6'6"	4763	4775	-	-
7'0"x7'0"	4764	4775	4766	4766
7'5"x6'6"	4764	4776	4764	4764
7'5"x7'0"	4766	4763	4766	4766
7'6"x6'6"	4764	4763	4764	4764
7'6"x7'0"	4764	4763	-	-
14'0"x6'6"	-	4768	4766	4766
14'0"x7'0"	-	4768	4768	4768



For price, please see pages 34 and 35

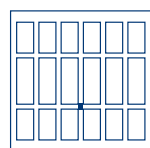

Wolsey

Spring Type

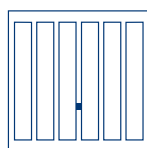

Seymour

Spring Type

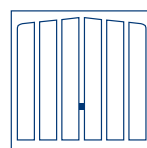

Tudor

Spring Type

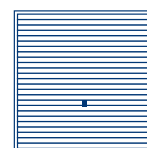







Horizontal Cedar

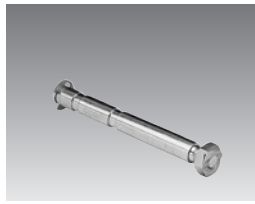
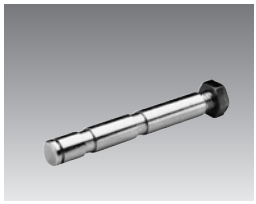
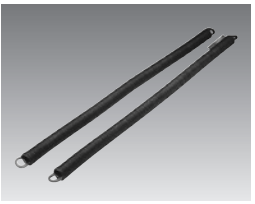



Spring Type



7'0"x6'6"	4764	4764	4764	N/A
7'0"x7'0"	4764	4764	4764	N/A
7'5"x6'6"	4764	4764	4764	N/A
7'5"x7'0"	4766	4766	4766	N/A
7'6"x6'6"	4764	4764	4764	-
7'6"x7'0"	4766	4766	4766	-
14'0"x6'6"	4763	4763	4763	-
14'0"x7'0"	4764	4764	4764	-

Single and Double Retractable Gear Components

				
Article	Spring Anchor Pin E-clip supplied suitable for DC/ DR/ FR/ R Sold individually	Spring Anchor Pin Suitable for R/FR/DR from 1988 to 2002	Single, Double and Framed Retractable Door Spring - 595 mm Pre 2002	Single, Double and Framed Retractable Door Spring - 595 mm Pre 2002
Ref. No.	1211	1214	4763	4764
Price £	14.00	11.00	88.00	88.00



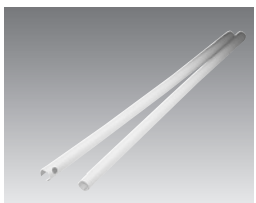
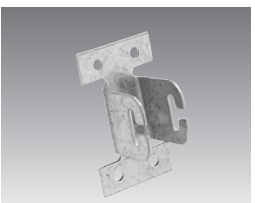

				
Article	Single, Double and Framed Retractable Door Spring - 595 mm Pre 2002	Single, Double and Framed Retractable Door Spring - 595 mm Pre 2002	Single, Double and Framed Retractable Door Spring - 595 mm Pre 2002	Single, Double and Framed Retractable Door Spring - 595 mm Pre 2002
Ref. No.	4765	4766	4768	4769
Price £	88.00	88.00	88.00	88.00



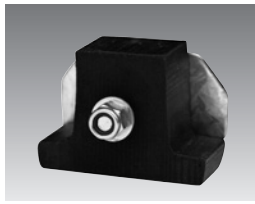

				
Article	Single, Double and Framed Retractable Door Spring - 595 mm Pre 2002	Single, Double and Framed Retractable Door Spring - 595 mm Pre 2002	Single, Double and Framed Retractable Door Spring - 595 mm Pre 2002	Single, Double and Framed Retractable Door Spring - 595 mm Pre 2002
Ref. No.	4770	4774	4775	4776
Price £	88.00	88.00	88.00	88.00





				
Article	Single, Double and Framed Retractable Door Spring - 595 mm Pre 2002	Retractable Door Spring Cover Tubes Suitable for all R, FR and DR springs. Length 595 mm	Spring Anchor Bracket From 1988 - 2002	Track for Double Retractable Doors
Ref. No.	4777	1151	345	(LH) 301, (RH) 300
Price £	88.00	11.00	13.00	58.00



GARADOR Up & Over Doors (Pre 2002)

Double Canopy Doors

				
Article	Rubber stop DC type only from 1992	Double Canopy Spring	Double Canopy Door Spring - 685 mm Pre 2002	Double Canopy Door Spring - 685 mm Pre 2002
Ref. No.	1213	4773	4748	4749
Price £	14.00	88.00	88.00	88.00

				
Article	Double Canopy Door Spring - 685 mm Pre 2002	Double Canopy Door Spring - 685 mm Pre 2002	Double Canopy Door Spring - 685 mm Pre 2002	Double Canopy Door Spring - 685 mm Pre 2002
Ref. No.	4750	4751	4752	4753
Price £	88.00	88.00	88.00	88.00

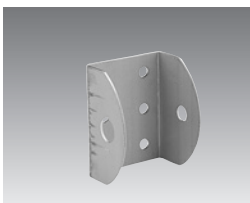
				
Article	Double Canopy Door Spring - 685 mm Pre 2002	Double Canopy Door Spring - 685 mm Pre 2002	Double Canopy Door Spring - 685 mm Pre 2002	Double Canopy Door Spring - 685 mm Pre 2002
Ref. No.	4754	4755	4756	4757
Price £	88.00	88.00	88.00	88.00

				
Article	Double Canopy Door Spring - 685 mm Pre 2002	Roller Bracket (on door) Suitable for DC/ DR from 1988 to 2002	Track for Double Canopy Doors up to 7'0	Track for Double Canopy Doors over 7'0
Ref. No.	4758	344	(LH) 299, (RH) 298	(LH) 297, (RH) 296
Price £	88.00	10.00	110.00	118.00

Double Canopy Doors

Double Canopy Type Spring - Steel Panel Doors

Used on all DC and DR type doors pre 2002 (685 mm long).



For price, please see page 35

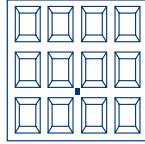

Georgian

DC Spring

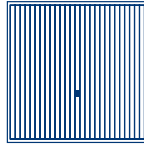

Carlton

DC Spring

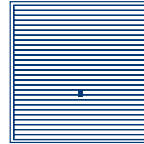

Horizon

DC Spring

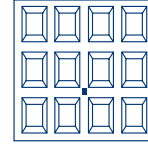

Parade-White/Brwon

DC Spring

9'0"x6'6"	4755	4754	4752	-
9'0"x7'0"	4756	4754	4754	-
10'0"x6'6"	4756	4754	4752	-
10'0"x7'0"	4756	4756	4754	-
11'0"x6'6"	4756	4755	4754	-
11'0"x7'0"	4757	4757	4756	-
12'0"x6'6"	4758	4756	4755	-
12'0"x7'0"	4758	4758	4757	-
13'0"x6'6"	4750	4758	4757	-
13'0"x7'0"	4752	4749	4758	-
14'0"x6'6"	4751	4748	4758	4753
14'0"x7'0"	4753	4750	4758	4754
15'0"x6'6"	-	4758	4758	-
15'0"x7'0"	-	4752	4750	-
16'0"x6'6"	-	4751	4750	-
16'0"x7'0"	-	4753	4752	-

Double doors not sold as Elite.

GARADOR Up & Over Doors (Pre 2002)

Double Canopy type Doors

Double Canopy Type Spring - GRP Premier Panel Doors

Used on all DC and DR type doors pre 2002.



For price, please see page 35

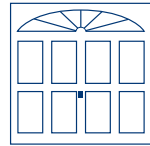

Stamford

DC Spring

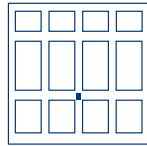

Arden

DC Spring

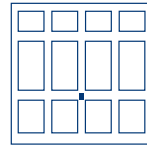

Kenmore

DC Spring

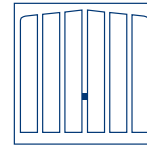

Clifton

DC Spring

9'0"x6'6"	4750	4750	4750	4750
9'0"x7'0"	4753	4753	4753	4753
10'0"x6'6"	4753	4753	4753	4753
10'0"x7'0"	4755	4755	4755	4755
11'0"x6'6"	-	4754	4754	-
11'0"x7'0"	-	4756	4756	-
12'0"x6'6"	-	4755	4755	-
12'0"x7'0"	-	4757	4757	-
14'0"x6'6"	4757	4757	4757	4757

Double Canopy Type Spring - Timber Panel Doors

Used on all DC and DR type doors pre 2002.

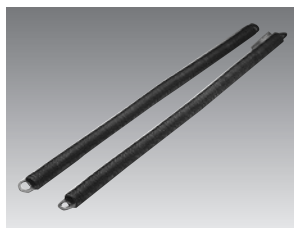

For price, please see page 35

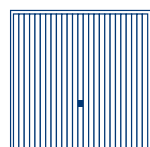

Vertical Cedar

DC Spring

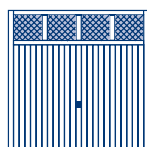

Sandhurst

DC Spring

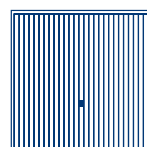

Cavendish

DC Spring

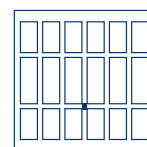

Wolsey

DC Spring

14'0"x6'6"	4748	4751	4751	4748
14'0"x7'0"	4748	4750	4750	4749



For price, please see page 35

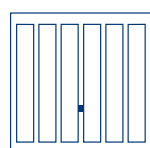

Seymour

DC Spring

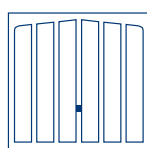







Tudor

DC Spring

14'0"x6'6"	4748	4748
14'0"x7'0"	4749	4749

Handles, Lock Assemblies and Keys

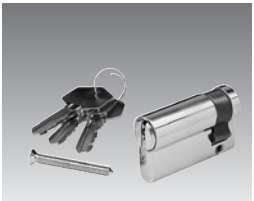



				
Article	ZA Series Locks Includes keys, washers, nuts and bolts. Back face - ZA0001-ZA0200	ZA Series Keys Key numbers between: ZA/0001 - ZA/ 0200	92 Series Keys Key numbers between: 92/ 201 - 92/ 400	Lock Barrel (1992 - 1998) Length 40 mm. For steel doors
Ref. No.	1164	1162	1163	1165
Price £	47.00	10.00	10.00	27.00

				
Article	Lock Barrel (1992 - 1998) Length 50 mm. T&G Timber	Lock Barrel (1992 - 1998) Length 70 mm. GRP/ Elizabethan	Single Door Brass Handle 1998 - April 2002	Double Door Black Handle 1998 - April 2002
Ref. No.	1166	1173	1183	1184
Price £	35.00	35.00	33.00	27.00

				
Article	Double Door Brass Handle 1998 - April 2002	Handle Conversion Kit Includes keys, washer, plastic cups, screws, counterplates, plastic crank, slit bolt and nut	T- Handle Assembly Includes keys, washer, slit bolt and nut, plastic cups and screws. Key no. between 201 and 400	Handle Repair Kit DR/ DC type only up to Dec. 1993 (latch cable only)
Ref. No.	1185	1171	1191	1170
Price £	37.00	50.00	43.00	15.00

GARADOR *Garage Side Doors (2002 - current)*

Garage Side Doors

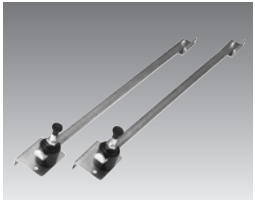

				
Article	Black Lever/ Knob Handle Side Hinged Doors	Black Lever/ Lever Handle Side Hinged Doors	White Lever/ Lever Handle Side Hinged Doors	Chrome Effect Lever/ Lever Handle Side Hinged Doors
Ref. No.	3348	6152	3349	3351
Price £	26.00	30.00	106.00	136.00

				
Article	Shoot Bolt For side hinged door. 2002 - current	Door Hinge for Sidehung Garage Door (please state colour required)	Cylinder for Side Hinged steel doors	Cylinder for Side Hinged timber doors
Ref. No.	395	385	393	6112
Price £	25.00	28.00	37.00	37.00



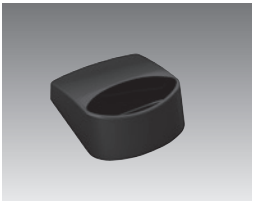
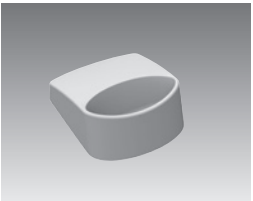

		
Article	Lock Body 2002 - current	Side Hung Door Stays
Ref. No.	390	2449
Price £	46.00	65.00

GaraMatic Operators

				
Article	5 Button Hand Transmitter (Gloss Black) 868 mHz bi-directional	5 Button Hand Transmitter Matt Black 868 mHz bi-directional	5 Button Hand Transmitter (Gloss White) 868 mHz bi-directional	4 Button Hand Transmitter (Gloss Black) 868 mHz bi-directional
Ref. No.	6714	7471	6713	6779
Price £	75.00	75.00	82.00	62.00





				
Article	1 Button Hand Transmitter (Gloss Black) 868 mHz bi-directional	Hand Transmitter Station in Gloss Black	Hand Transmitter Station in Gloss White	Hand Transmitter Sun Visor / Wall Holder
Ref. No.	6710	6719	6720	6784
Price £	60.00	12.00	12.00	10.00

				
Article	4 Button Hand Transmitter Matt Black 868 mHz bi-directional	2 Button Hand Transmitter (Gloss White) 868 mHz bi-directional	2 Button Hand Transmitter (Carbon Fibre) 868 mHz bi-directional	2 Button Hand Transmitter (Gloss Green) 868 mHz bi-directional
Ref. No.	7470	6711	6966	6965
Price £	60.00	65.00	80.00	80.00



				
Article	2 Button Hand Transmitter (Gloss Red) 868 mHz bi-directional	2 Button Hand Transmitter (Wood) 868 mHz bi-directional	2 Button Hand Transmitter (Aluminium) 868 mHz bi-directional	1 Button Transmitter for car cigarette lighter bi-directional
Ref. No.	6964	6968	6967	6782
Price £	80.00	80.00	80.00	56.00

GARADOR *Electric Operators*

GaraMatic Operators

				
Article	2 Button Transmitter for car cigarette lighter (bi-directional)	4 Channel Key Fob Transmitter 868 mHz (bi-directional)	Aluminium Designer 2 Channel Transmitter 868 mHz (bi-directional)	Chrome Designer 2 Channel Transmitter 868 mHz (bi-directional)
Ref. No.	6783	6795	6780	6781
Price £	56.00	68.00	84.00	84.00

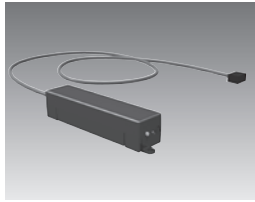
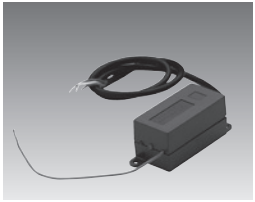
				
Article	HS4 Blue buttons 868 mHz	HSM4 Grey buttons 40 mHz	HSE2 Grey buttons 40 mHz	HS4 Grey buttons 40 mHz
Ref. No.	680	676	677	674
Price £	58.00	58.00	58.00	58.00

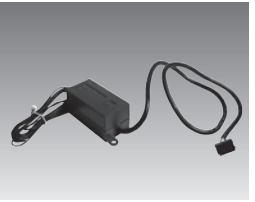
				
Article	HE3 868 mHz bi-directional Internal Receiver (not to be used outside)	Radio Receiver Blue button 868 mHz (white aerial lead)	Receiver IP65 868 mHz	Radio Receiver Grey button 40 mHz
Ref. No.	6785	690	6715	685
Price £	111.00	90.00	204.00	81.00



Please note: GaraMatic Series 3 handsets can be downgraded to work on 868 mHz blue button handsets (HS4, HSM4, HSE2).

GaraMatic Operators

				
Article	IT1 Push Button	IT1B Illuminated Push Button	IT3B Wired Wall Console	FIT2 Wireless Wall Console 868 mHz bi-directional
Ref. No.	695	2875	2873	6718
Price £	18.00	29.00	40.00	62.00

				
Article	FCT10 Wireless Code Switch (slide lid) 868 mHz bi-directional	FCT3 Bi-directional Wireless Code Switch 868 mHz	FFL12 Bisecur Wireless Finger Scanner (with lid)	ESA40 Face-Fixed Key Switch
Ref. No.	6716	6717	6796	2876
Price £	164.00	100.00	212.00	52.00

				
Article	ESU40 Recessed Key Switch	EL101 Internal Light Beam Device	EL301N Light Beam Device	Emergency Release For retractable doors with lock and handle
Ref. No.	2877	6786	2884	704
Price £	76.00	68.00	118.00	29.00

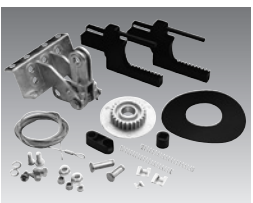
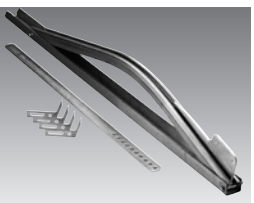
				
Article	Emergency Release Canopy doors or sectional doors without handles	Emergency Release For sectional doors with lock and handle	Delatching Kit For all single and double retractable doors	Bow Arm For canopy doors
Ref. No.	703	702	2643	708
Price £	42.00	43.00	47.00	85.00

GARADOR *Electric Operators*

GaraMatic Operators

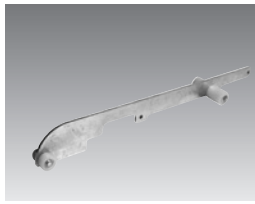
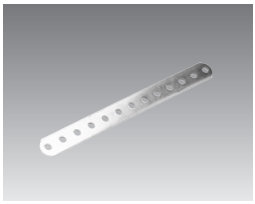
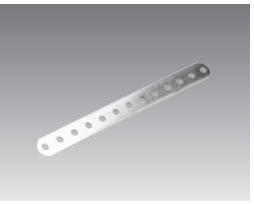
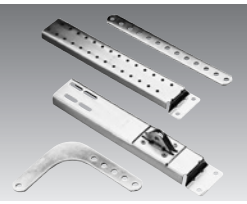
				
Article	Canopy Extension Bracket	Extended Towing Arm 258 mm long	Extended Towing Arm 495 mm long	Reinforcing Kit For sectional doors. Recommended on Classic Sectional Doors
Ref. No.	709	2482	2628	712
Price £	42.00	16.00	35.00	50.00

				
Article	Options Relay (GaraMatic 10 and 20 add-on)	Options Relay (GaraMatic 7 and 9 add-on)	Emergency Accumulator	Key Ring
Ref. No.	3072	5295	5500	4877
Price £	37.00	37.00	139.00	3.00

EuroPro



		
Article	Euro Pro Hand Transmitter	Eco Star Hand Transmitter 433 mHz RSC2 remote hand transmitter for Euro Pro operator
Ref. No.	6251	7315
Price £	64.00	52.00

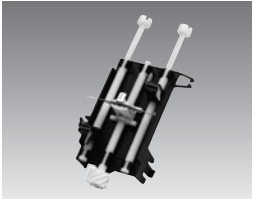

Autodor

		
Article	Autodor Elite Trolley Rack	Autodor Limit Assembly
Ref. No.	1239	1235
Price £	35.00	30.00

GARADOR Consumables

Bulbs and Batteries

			
Article	Bulb Suitable for M2 and Expert	Bulb Suitable for GaraMatic 7 and 9 operators Auto Expert	Bulb Suitable for GaraMatic 10 and 20 operators
Ref. No.	2641	715	4643
Price £	8.00	7.00	10.00

			
Article	CR2032 Battery Suitable for wall consoles etc.	A11 Battery Suitable for HSE2 hand transmitter	A23 Battery Suitable for HS2, HSM2, HS4 and HSM4
Ref. No.	4644	2521	2522
Price £	9.00	9.00	9.00

Touch Up Paint



Aerosol Spray
£ 30.00 ea.



Touch up Pot
£ 6.00 ea.

	Ref. No.	Ref. No.
Rosewood effect	6851	5387
Golden Oak effect	6852	3258
Light Ivory (RAL 1015)		7177
Ruby Red (RAL 3003)	6821	2740
Signal Blue (RAL 5005)	6822	2742
Steel Blue (RAL 5011)	6819	3256
Pigeon Blue (RAL 5014)		7178
Moss Green (RAL 6005)	6837	2743
Fir Green (RAL 6009)	7328	7180
Anthracite Grey (RAL 7016)	7333	7179
Mid Grey (RAL 7030)	7332	7181
Light Grey (RAL 7035)	7330	7182
Window Grey (RAL 7040)	7329	7183
Ochre Brown (RAL 8001)	7327	7184
Clay Brown (RAL 8003)	7335	7185
Terra Brown (RAL 8028)	6818	3255
Jet Black (RAL 9005)	6817	2741
White Aluminium (RAL 9006)	7331	7186
Grey Aluminium (RAL 9007)	7336	7187
Traffic White (RAL 9016)	6820	3254

GARADOR *Warranty*

Warranty

Garador products are manufactured to the highest quality standards and leave our factory only after rigorous quality testing. However, if you should have grounds for complaint, this section tells you what our door warranty offers, and how to go about making your claim.

Warranty Period

The purchaser is granted a warranty covering the safe and reliable function of the Garador garage door for a period of 10 years from the date of purchase. A 5 year warranty applies to springs, wire cables, track rollers, hinges and guide rollers. The warranty period for replacement parts is 12 months or to the end of your existing warranty period on the door, whichever is longer.

In the case of foil-coated timber effect and PVC doors, a warranty of 5 years is granted, for timber and GRP doors a warranty of 2 years is granted on the door panels alone under the terms and conditions specified herein. The door mechanism and steel frame (if applicable) is covered by the 10 year warranty period.

Performance

During the warranty period we will replace any and all defective parts which can be proved to be attributed to a material or manufacturing fault. We do not accept costs for dismantling and installation nor for carriage.

Requirements

Warranty claims are only applicable in the country where the parts are purchased. The parts must have been purchased through our authorised distribution channels. The warranty only covers damage to the contract object.

Garador Installers

Installing of replacement parts can be dangerous and lead to further problems. We would always recommend installation of any replacement part to be carried out by a Recommended Garador Installer. For further details please call us on 01935 443722 or refer to the Garador website.