



# Steel doors

Function doors for homes and construction projects

**NEW:** Multi-purpose door MZ and fire-rated door H8-5 in 7 preferred colours

**HÖRMANN**





## CONTENT

6	Good reasons to try Hörmann
10	Security door KSI Thermo46
12	Security door KSI 40-1
14	Multi-purpose door MZ Thermo46 / MZ Thermo65
16	Multi-purpose door MZ
18	Fire-rated door H3 OD
20	Fire-rated door H8-5
22	Internal door ZK
24	Internal door OIT 40
26	Equipment
27	Colours and decor surfaces
28	Steel frames
30	Size range of steel doors
32	Dimensional references of steel doors
35	Size range of frames
35	Frame wall connections
36	Residential doors
38	Programme overview

The colours and surface finishes shown are subject to the limitations of the printing process and cannot be regarded as binding.

All rights reserved. No part may be reproduced without our prior permission. Subject to changes.

\* Up to 49 % better thermal insulation for the MZ Thermo65 compared to a conventional multi-purpose door

Products on title page (from left): fire-rated door H8-5 in Grey white RAL 9002, external security door KSI Thermo46 in Anthracite RAL 7016

◀ Internal door ZK in Traffic white RAL 9016



# The right door for every room – your security is guaranteed

Whether for new construction or modernisation projects, Hörmann offers the right door with suitable functions for houses and blocks of flats, schools and offices, as well as for industrial and trade buildings: Whether it is security doors for side or front entrances, fire-retarding doors for heating rooms, multi-purpose doors for work and utility areas or internal doors for offices and classrooms, you are guaranteed to find your preferred door in the Hörmann steel doors programme. Discover all the advantages and functions of our high-quality steel doors and individual design possibilities on the following pages.



Blocks of flats



Schools and authorities



Industrial and trade companies

The classification of the individual doors shows you at a glance which functions the respective door fulfils and to what extent – from highly suitable (★★★★★ / 5 stars) to unsuitable (no stars).

◀ House with multi-purpose door MZ Thermo65

“A good reputation must be earned.”

August Hörmann

In keeping with the tradition started by the company's founder, the name Hörmann delivers brand name quality with extensive product expertise. The family business has over 80 years of experience as a construction component specialist and sees itself as your partner from the very beginning of building and renovation projects. It's no surprise that Hörmann is one of Europe's most successful door providers. This makes a Hörmann door a reassuring purchase.



## 1 Made in Germany

All doors are developed and manufactured by Hörmann. Our highly qualified employees work intensively on new products, continual further developments and improvements to details. The results are patents and unique products on the market. Endurance tests under real conditions ensure **mature series products with Hörmann quality.**



## 2 Brand quality for generations

We are convinced of our products and our uncompromising quality assurance. That is why **you will enjoy a Hörmann function door in your house for many years.**

## 3 An eye on the future

Hörmann is setting a good example. This is why the company obtains **100 % of its energy consumption from green sources.** Together with an intelligent and certified energy management system, CO<sub>2</sub>-neutral mailing and the recycling of valuable materials, **more than 40000 tons of CO<sub>2</sub> are saved each year.** And last but not least, Hörmann also offers products for sustainable construction.

Up to  
**49%\***  
better  
thermal insulation

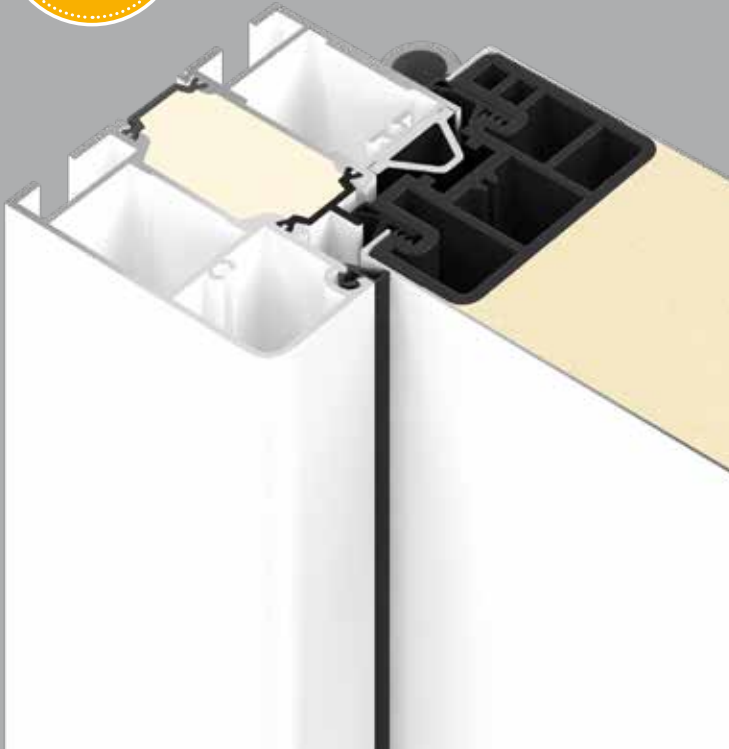

## 4 Up to 49 % improved thermal insulation

You are looking for basement and side doors with the same thermal insulation as your entrance door? Then our security door KSI Thermo46 and multi-function doors MZ Thermo46 and MZ ThermoPlus65 are the right choice for you: **the MZ ThermoPlus65 provides up to 49 % better thermal insulation than conventional multi-purpose doors.**

Further information can be found on pages 10 / 11 or 14 / 15.

**RC 2**  
Certified  
safety



## 5 Break-in-resistant RC 2 security equipment

Security doors KSI 40-1 / KSI Thermo46 are available **with approved, break-in-resistant RC 2 security equipment as standard.** For you, this means feeling even more secure in your own home. For fire-rated door H3 OD, the equipment is optionally available as an additional function.



Our security doors' certified break-in resistance is also recommended by police information centres.

\* Up to 49 % better thermal insulation for the MZ Thermo65 compared to a conventional multi-purpose door





## 6 Steel profile frame VarioFix

For the Hörmann steel profile frame VarioFix, wall tolerances of up to 20 mm are no problem: The adjustable decorative rebate easily compensates for different wall thicknesses during renovations and new construction projects. As easy to fit as a timber frame, the steel profile frame is additionally distinguished by its long service life and attractive design. **Only VarioFix offers high resistance and an elegant shape without visible foldback coupled with the fitting principle of timber frames.** Additional information about our frame types can be found on pages 30 / 31.

## 7 Door operator PortaMatic

Are you physically disabled or would you simply **like more convenience**? Then equip your internal doors with the innovative door operator PortaMatic. This allows you to **automatically close and open** the doors via a hand transmitter or button, improving your **quality of life**.



# KSI Thermo46

## High security and the best thermal insulation

Thanks to the door leaf with thermal break, security door KSI Thermo46 offers the best thermal insulation and reduces the risk of condensation forming in heated rooms. The break-in-resistant RC 2 security equipment means you can also feel secure in your home. We recommend using this quality door as an external door for basements, outbuildings and garages.

<b>Break-in resistance</b>
★★★★★
<b>Thermal insulation</b>
★★★★★
<b>Acoustic insulation</b>
★★
<b>Fire-retarding</b>
<b>Smoke-tightness</b>
<b>Stress</b>
★★★★★
<b>Deformation resistance</b>
★★★★★



## Product characteristics

### External door for

- Basements
- Heated outbuildings
- Garages with direct access to the house

### Ready-to-fit door set

Door leaf and frame with thermal break, door leaf galvanized and painted in Traffic white (similar to RAL 9016)

### Single-leaf

**Break-in-resistant, RC 2** according to DIN EN 1627 on closing side

### Thermally insulated

$U_D = 1.1 \text{ W}/(\text{m}^2 \cdot \text{K})$

### The same thermal insulation as with entrance doors

These days, saving energy is important throughout the entire home. Security door KSI Thermo46 provides excellent thermal insulation thanks to the **door leaf filled with PU rigid foam**; door leaf, frame and threshold all come with **a thermal break**. The door also features double seals on all four sides. With all of this, the KSI Thermo46 has a thermal insulation value usually only found in entrance doors.

### Security as standard

Basement and side doors are often weak spots when it comes to security. In this respect, the KSI Thermo46 offers the best equipment as well: 2 conical swing bolts, 2 additional security bolts **4** and 1 lock bolt **3** engage in the frame's lock plate and firmly pull the door shut. 3 further security bolts **5** and 3 guide rollers **2** on the hinge side make it practically impossible to force the door open.

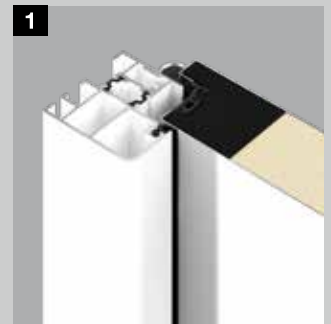

**1** The security door KSI Thermo46 features a 46 mm thick door leaf and a very good thermal insulation value of up to  $1.1 \text{ W}/(\text{m}^2 \cdot \text{K})$ .

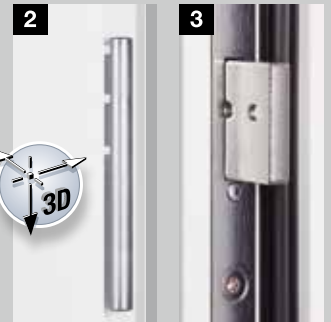

**2** Three-way adjustable guide rollers for easy door function

**3** Lock bolt for standard security

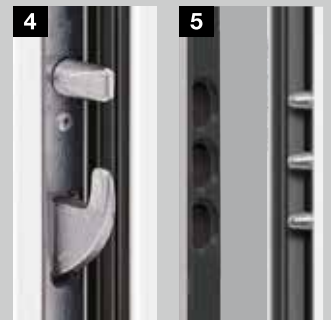

**4** Swing bolt with security bolts

**5** Security bolts on the hinge side



Colours and decor surfaces

Page 27

Size range

Page 30

01933 229135

\* Up to 30 % better thermal insulation compared to a conventional security door

[www.thegaragedoorcentre.co.uk](http://www.thegaragedoorcentre.co.uk)

[enquiries@thegaragedoorcentre.co.uk](mailto:enquiries@thegaragedoorcentre.co.uk)



# KSI 40-1

## The proven classic for more security

Basement entrances, outbuildings and garages are often equipped with old doors that can be forced open in seconds. Always remember: if the basement door is open, the whole house is accessible. This is why we recommend security door KSI 40-1 with standard security equipment for these areas.

<b>Break-in resistance</b>
★ ★
<b>Thermal insulation</b>
★ ★ ★ ★ ★
<b>Acoustic insulation</b>
★ ★
<b>Fire-retarding</b>
<b>Smoke-tightness</b>
<b>Stress</b>
★ ★ ★ ★ ★
<b>Deformation resistance</b>
★ ★ ★ ★ ★



## Product characteristics

### External door for

- Basements
- Unheated outbuildings
- Free-standing garages

### Ready-to-fit door set

Door leaf and frame, galvanized and with powder-coated primer in Traffic white (similar to RAL 9016)

### Single-leaf

#### Break-in-resistant, RC 2

According to DIN EN 1627 on the opening and closing side

#### Thermally insulated

$U_D = 1.7 \text{ W/(m}^2\cdot\text{K)}$

#### Acoustic-rated

Rw approx. 31 dB  
With double lip seal and semi-circular threshold as standard

Rw approx. 32 dB  
With optional retractable bottom seal

#### Climatic class III

acc. to RAL-RG 426

#### Duty category S

acc. to RAL-RG 426



Colours and decor surfaces

Page 27

Size range

Page 30

01933 229135

### Sturdy door leaf

The KSI 40-1 features a double-skinned, 40 mm thick door leaf with 3-sided thick rebate and sheet steel on both sides (0.8 mm). The stability of the door leaf is a result of the all-round reinforcement frame and the mineral wool insert which is glued over the entire surface. A 3-sided EPDM seal and double lip seal (incl. aluminium semi-circular threshold as a bottom edge) seal the door reliably. This means you can always rely on the door in terms of function and tightness. Hörmann offers this door as a complete door set with frame.

### High safety

The standard security of the KSI 40-1 lets you and your family sleep peacefully, as it comes with pull-off protection and a drill-resistant security lever / knob handle set **3**. The solid steel bolts on the hinge side **5** make it almost impossible to force the door open. The KSI 40-1 has been tested in accordance with European standard DIN EN 1627 on the opening and closing side and has resistance class 2.



1.5 mm thick corner frame with all-round seal

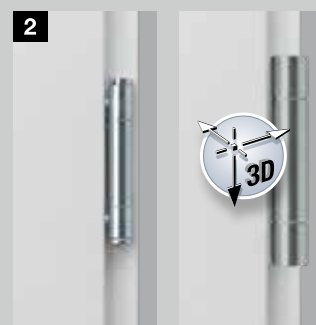

3-part hinge (standard)

Three-way adjustable VX hinge (on request)



Security lever / knob handle set with drill resistance and pull-off protection

Lock bolt for standard security



Solid steel security bolts on the hinge side

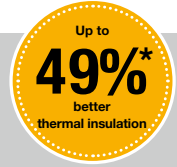

# MZ Thermo65 / MZ Thermo46

## External doors with thermal break and the best thermal insulation values

The multi-purpose doors are more than just extremely robust. Thanks to the thermal break, they offer up to 49 % better thermal insulation and reduce the risk of condensation forming in heated rooms. They are available with or without glazing as well as in numerous colours and decor surfaces.

<b>Break-in resistance</b>
★ ★
<b>Thermal insulation</b>
★ ★ ★ ★ ★
<b>Acoustic insulation</b>
★ ★
<b>Fire-retarding</b>
<b>Smoke-tightness</b>
<b>Stress</b>
★ ★ ★ ★ ★
<b>Deformation resistance</b>
★ ★ ★ ★ ★



## Product characteristics

### External door for

- Basements
- Heated outbuildings
- Garages with direct access to the house
- Workshops and hobby rooms

### Ready-to-fit door set

Door leaf and frame with thermal break, door leaf galvanized and painted in Traffic white (similar to RAL 9016)

### Single-leaf

#### Thermally insulated

MZ Thermo65

THP 011:  $U_D = 0.87 \text{ W}/(\text{m}^2\cdot\text{K})$

THP 051:  $U_D = 1.0 \text{ W}/(\text{m}^2\cdot\text{K})$

MZ Thermo46

TPS 011:  $U_D = 1.1 \text{ W}/(\text{m}^2\cdot\text{K})$

TPS 021:  $U_D = 1.4 \text{ W}/(\text{m}^2\cdot\text{K})$

TPS 051:  $U_D = 1.6 \text{ W}/(\text{m}^2\cdot\text{K})$

#### TPS 021 / 051 glazing

Double insulated glazing (24 mm) with a U-value of up to approx.  $1.4 \text{ W}/(\text{m}^2\cdot\text{K})$ , with synthetic glazing frame

#### Glazing THP 051

Triple insulated glazing (46 mm) with a U-value of up to approx.  $1.0 \text{ W}/(\text{m}^2\cdot\text{K})$ , with synthetic glazing frame

### High thermal insulation

The MZ Thermo65 / MZ Thermo46 multi-purpose doors will help you reduce heating losses permanently. The door leaf with PU rigid foam infill, frame and threshold all come with a thermal break. This and the all-round double seals on all four sides make sure the door is perfectly sealed and improves thermal insulation by up to 49 % compared to a conventional multi-purpose door.

### Stability and functionality

The MZ Thermo46 / MZ Thermo65 is exceptionally stable and robust thanks to the fully filled door leaf. The door can be optimally adjusted using the three-way adjustable guide rollers.

### With or without glazing

On request, the MZ Thermo65 / MZ Thermo46 also comes with glazing to let daylight into your workshop or hobby room. The glazed versions also offer excellent thermal insulation on the interior and exterior thanks to insulated safety glass.



#### The multi-purpose door

**MZ Thermo65** offers first class insulation with a 65 mm thick door leaf and a particularly high  $U_D$ -value of up to  $0.87 \text{ W}/(\text{m}^2\cdot\text{K})$ .



#### The multi-purpose door

**MZ Thermo46** features a 46 mm thick door leaf and a thermal insulation value of up to  $1.1 \text{ W}/(\text{m}^2\cdot\text{K})$ .



Glazing frame Roundstyle in TPS 021



Glazing frame Profilstyle in THP 051 / TPS 051

You may choose from 3 styles: with a solid door leaf or glazing.



THP 011 / TPS 011



TPS 021S Satinato glazing



THP 051S / TPS 051S Satinato glazing, TPS 051F clear glass

\* Up to 49 % better thermal insulation compared to a conventional multi-purpose door



Colours and decor surfaces

Page 27

Size range

Page 30

# MZ

## Stable and inexpensive internal and external door

Proven for over four decades, this multi-purpose door is stable, durable and weather-resistant, making it ideal for inside and outside applications. The MZ comes in a single-leaf or double-leaf design and is available with glazing on request.

<b>Break-in resistance</b>
★ ★
<b>Thermal insulation</b>
★ ★ ★
<b>Acoustic insulation</b>
★ ★ ★
<b>Fire-retarding</b>
<b>Smoke-tightness</b>
<b>Stress</b>
★ ★ ★ ★ ★
<b>Deformation resistance</b>
★ ★ ★ ★ ★





## Product characteristics

### Internal and external door for

- Unheated outbuildings
- Utility sheds
- Storage rooms

### Ready-to-fit door set

Door leaf and frame, galvanized and with powder-coated primer in Grey white (similar to RAL 9002)

### Single- or double-leaf

### Dual handed (with corner frame)

### Thermally insulated

$U_D = 1.7 \text{ W}/(\text{m}^2 \cdot \text{K})^*$

### Acoustic-rated

Rw approx. 39 dB\*

### Possible additional functions:

### T30 fire-retarding\*

As a fire-rated door H8-5 up to door size 1000 x 2125 mm (see page 18)

\* For doors without glazing and with corner frame

### Stability for you

This ready-to-fit door set is especially robust thanks to a double-skinned, 45 mm thick door leaf rebated on both sides, sheet thickness of 0.9 mm, mineral wool infill and steel reinforcement. The door provides a very high level of security with 2 solid steel security bolts. A 2 mm thick corner frame with all-round EPDM seal keeps the door shut tight and has a threshold rail that can be easily removed. The door is also available with a block frame and a 3-sided EPDM seal on request.



2 mm thick corner frame with all-round seal

### More light thanks to glazing

Hörmann also offers its multi-purpose door MZ with glazing. Due to security reasons, this glazing is kept very narrow or very small, but it still lets you benefit from daylight inside. 7 mm wired glass is provided as standard, but 20 mm insulated wired glass with a view of 230 x 1360 mm is also possible. The natural-finish aluminium glazing frame is fastened on the closing side with glazing beads as standard. For doors opening inwards, the glazing frame is optionally available with glazing beads on the opening side.



Round glazing (optional)



Glazing view 5 (optional)



Glazing view 9 (optional)





# H3 OD

## The functional door between garage and home

Due to fire hazards in garages, a fire-rated door between the house and garage is required by law. The H3 OD is the best choice for this sensitive area. On request, this door can also act as a seal against smoke and engine noise and additionally protects your family from burglars with the RC 2 security package.

<b>Break-in resistance</b>	★ ★ ☆ ☆ ☆
<b>Thermal insulation</b>	★ ★
<b>Acoustic insulation</b>	★ ★ ★ ☆ ☆
<b>Fire-retarding</b>	★ ★ ★ ★ ★
<b>Smoke-tightness</b>	☆☆☆☆☆
<b>Stress</b>	★ ★ ★ ★ ★
<b>Deformation resistance</b>	★ ★ ★ ★ ★
	★ for standard equipment
	☆ with optional equipment



## Product characteristics

### Internal door and external door for

- fire protection requirements

The choice of an internal or external door depends on the fitting situation (protected / unprotected) and on the requirements of the performance characteristics.

### Ready-to-fit door set with universal corner frame

Door leaf and frame, galvanized and with powder-coated primer in Grey white (similar to RAL 9002)

### Single- or double-leaf

### Thermally insulated

$U_D$ -value of up to  $1.5 \text{ W}/(\text{m}^2 \cdot \text{K})$

**T30 fire-retarding**  
acc. to DIN 4102

**EI<sub>230</sub> fire-retarding**  
acc. to EN 16034

### Sealing $S_a$

**Self-closing characteristic C5** 200000 cycles

**Possible additional functions:**

**Break-in-resistant RC 2\*\***  
acc. to DIN EN V 1627

**Acoustic-rated\***  
acc. to DIN EN ISO 717.1  
with 32 – 43 dB

**Smoke-tight S200**  
acc. to DIN 18095

**Smoke-tight RS**  
acc. to DIN 18095

### Glazings\*\*\*

Clear fire-proof glass F30

### Door leaf glued over the entire surface

The fully bonded composite construction of the door leaf ensures particularly high stability. The door always closes securely and accurately with a satisfying noise. The risk of door leaf warping or unevenness is virtually eliminated by the permanently flush surface.

### Rebate and door leaf on request

We supply the fire-rated door H3 OD in a thin rebate version as standard. The door comes in a thick rebate version for an identical view with your internal doors or in a version with a flush-closing door leaf for a very elegant door appearance on request.

### With optional glazing

On request, the fire-rated door H3 OD is available with clear fire-proof glass for more light. These doors are equipped with an additional overhead door closer.



### A frame for all wall types

The fire-rated door H3 OD is fitted quickly, easily and flexibly with the universal corner frame as standard. Thanks to the diagonal or anchor plate, the frame can be fitted in almost all fitting situations and wall types. The universal corner frame can be easily upgraded to a profile frame with the Vario B53 counter frame.



Thin rebate version as standard



Optional thick rebate version



Universal corner frame, brickwork

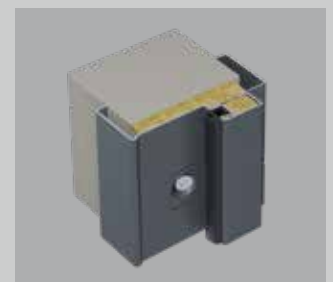

Universal corner frame with counter frame Vario B53, concrete

\* The acoustic values apply to solid doors without glazing and are not applicable to doors fitted into gas concrete.

\*\* The resistance class RC 2 applies to doors without glazing and is not applicable to doors fitted into partition walls.

\*\*\* Please note: Glazed doors require an overhead door closer.



# H8-5

## The best-selling boiler room door in Europe

For decades, the fire-rated door H8-5 has been providing optimum safety for boiler rooms and rooms with oil tanks. This door is the best example of how you can benefit from Hörmann's expertise in fire protection.

<b>Break-in resistance</b>
★ ★
<b>Thermal insulation</b>
★ ★ ★
<b>Acoustic insulation</b>
★ ★ ★
<b>Fire-retarding</b>
★ ★ ★ ★ ★
<b>Smoke-tightness</b>
☆☆☆☆☆
<b>Stress</b>
★ ★ ★ ★ ★
<b>Deformation resistance</b>
★ ★ ★ ★ ★
★ for standard equipment
☆ with optional equipment



## Product characteristics

### Internal door for

- fire protection requirements

### Ready-to-fit door set

Door leaf and frame, galvanized and with powder-coated primer in Grey white (similar to RAL 9002)

### Single-leaf

### Dual handed

### Thermally insulated

acc. to EN ISO 12567-1

$U_D = 1.7 \text{ W}/(\text{m}^2 \cdot \text{K})^*$

### Acoustic-rated

acc. to DIN 52210

Rw approx. 39 dB\*

### T30 fire-retarding

acc. to DIN EN 1634

### Possible additional functions:

### Smoke-tight

acc. to DIN 18095

with overhead door closer, smoke-tight seal and threshold\*\*

\* With all-round seal

\*\* Not suitable for escape and rescue routes

### Sturdy door leaf

The double-skinned, 45 mm thick door leaf is rebated on two sides. With a sheet thickness of 0.9 mm it is extremely robust and is equipped with a fire-retarding mineral wool infill, steel reinforcement and 2 steel security bolts. The lock and lever handle set can be used with profile cylinders and deadlock keys. One deadlock key is provided.

### Integrated fire protection

On both the door and fire hatch, the fire-proof material is not exposed but is concealed on the front side across the full width and is inserted flush-fitting.

### Sealed all-round

The 2 mm thick corner frame with all-round seal reliably seals the fire-rated door H8-5. The bottom threshold rail is easy to remove if fitted with a continuous floor.



2 mm thick corner frame with all-round seal



The H8-5 fire hatch is recommended for rooms with oil tanks.



# ZK

## The durable and inexpensive door

Over many years, ZK doors have proven themselves as robust doors for inside rooms in houses and blocks of flats. ZK doors do not warp and come with a high-quality surface that is durable, resistant to stains and easy to clean. Reliable quality at a low price.

<b>Break-in resistance</b>
<b>Thermal insulation</b> ★ ★
<b>Acoustic insulation</b>
<b>Fire-retarding</b>
<b>Smoke-tightness</b>
<b>Stress</b> ★ ★ ★ ★
<b>Deformation resistance</b> ★ ★ ★ ★ ★



## Product characteristics

### Internal door for

- Basements
- Children's rooms
- Entrance to an unrenovated loft

### Door leaf or single, ready-to-fit door set

Door leaf and frame, galvanized and painted in Traffic white (similar to RAL 9016)

### Single- or double-leaf

### Thermally insulated

$U_D = 2.1 \text{ W}/(\text{m}^2 \cdot \text{K})^*$

### Acoustic-rated

Rw approx. 25 dB\*

### Climatic class III

acc. to RAL-RG 426

### Duty category S

acc. to RAL-RG 426

\* For doors without glazing and with corner frame

### Sturdy door leaf

The double-skinned, 40 mm thick door leaf with a thick rebate on 3 sides consists of galvanized sheet steel (0.6 mm) and a honeycomb insert glued over the entire surface, making it dimensionally stable and robust.

### Fully equipped as standard

As standard, you will receive the internal door ZK with a fitted lock and bright galvanized top hinge parts V 0020, firmly screwed into the reinforced sections, but without a lever handle set.

### As a door leaf or ready-to-fit with a frame

The internal door ZK is supplied as a door leaf or as a ready-to-fit door set, i.e. complete with lever handle set and special corner frame in Traffic white.

### Smooth, quiet closing

The door has a mortice lock with lever / knob acc. to DIN 18251 class 3 and is prepared for profile cylinders (backset 55 mm). The door closes easily and quietly since it is equipped as standard with a plastic catch and steel bolt, deadlock insert and key, and on request with a profile cylinder.

### Flexible fitting

Thanks to the height adjustment and individual surface design, ZK doors are also ideal for modernising any room from the basement to the roof. They can be flexibly used in existing standard frames and all Hörmann steel frames (prepared for series V 8000 hinges).

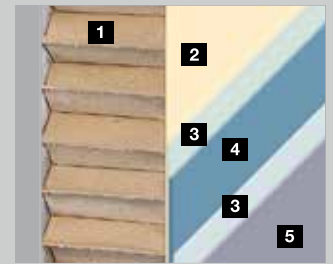

- 1 Honeycomb insert
- 2 Adhesive
- 3 Zinc coating
- 4 Steel
- 5 Powder coating / foil coating



You can individually design your door's smooth, silk matt surface.



The door leaf can be shortened at the bottom. With a height adjustment of up to 20 mm, this door is suitable for any modernisation project.

### Optional extras

Page 28



### Colours and decor surfaces

Page 27

### Size range

Page 30

# OIT 40

## Robust internal doors to meet high demands

The high-quality internal doors OIT 40 are particularly robust, dimensionally stable and durable. They are recommended for tough everyday use in industrial and commercial buildings, workshops, administrative buildings, schools and barracks. Thanks to the different infill variations, they also fulfil the special requirements of acoustic insulation and thermal insulation.

<b>Break-in resistance</b>
☆☆☆☆☆
<b>Thermal insulation</b>
★★☆☆
<b>Acoustic insulation</b>
★★☆☆
<b>Fire-retarding</b>
<b>Smoke-tightness</b>
<b>Stress</b>
★★★★★
<b>Deformation resistance</b>
★★★★★
★ for standard equipment
☆ with optional equipment





## Product characteristics

### Internal door for

- Offices
- Classrooms
- Work rooms

### Door leaf or single, ready-to-fit door set

Door leaf and frame, galvanized and painted in Traffic white (similar to RAL 9016)

### Single- or double-leaf

#### Thermally insulated

$$U_D = 2.1 \text{ W}/(\text{m}^2 \cdot \text{K})^*$$

With tubular chipboard

$$U_D = 1.7 \text{ W}/(\text{m}^2 \cdot \text{K})^*$$

With optional mineral wool insert, double lip seal and aluminium semi-circular threshold

#### Acoustic-rated

R<sub>w</sub> approx. 32 dB\*

With tubular chipboard

R<sub>w</sub> approx. 38 dB\*

With optional composite timber insert and retractable bottom seal

#### Climatic class III

acc. to RAL-RG 426

#### Duty category S

acc. to RAL-RG 426

#### Break-in-resistant, RC 2 (optional)

DIN EN 1627

\* For single-leaf doors in conjunction with corner frame and without glazing

### As a door leaf or door set

OIT 40 doors are available as a ready-to-hang door leaf or as a complete ready-to-fit door set. The door leaf is delivered with fitted lock and bright-galvanized top hinge parts V 0026 WF firmly screwed into the reinforced sections. The door set consists of a door leaf including lever handle set and a special corner frame made from 1.5 mm thick galvanized sheet steel with powder-coated primer in Traffic white (similar to RAL 9016) as standard.

### Frame equipment

The frame is fitted with an EPDM seal on 3 sides, with welded frame parts and grouting lugs. The door is delivered with corner and profile frame as well as block frame; you can also insert it into an existing standard frame or in every Hörmann steel frame.

### Door hinges selectable in the building system

The door can be optimally adjusted with maintenance-free 3-part hinges as standard. As an option, you can obtain three-way adjustable VX hinges.

### Mortice lever / knob lock

The lock is prepared for a profile cylinder (backset 55 mm) and fulfils all requirements of DIN 18251. The equipment includes a plastic latch and steel bolt, deadlock insert as well as a key. The lock is also supplied with a profile cylinder on request.

### Steel and timber well combined: particularly robust door leaves in three infill versions

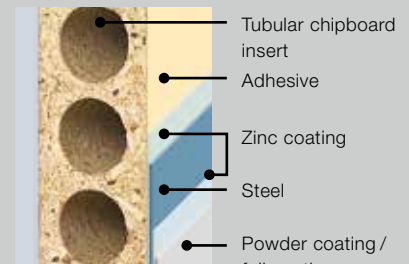

**Tubular chipboard insert** (Standard)

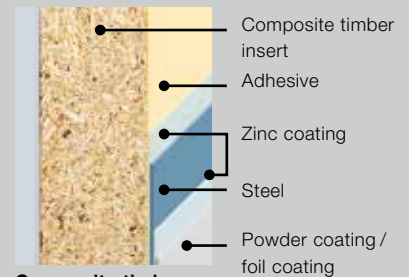

**Composite timber insert** (optional) for improved acoustic insulation

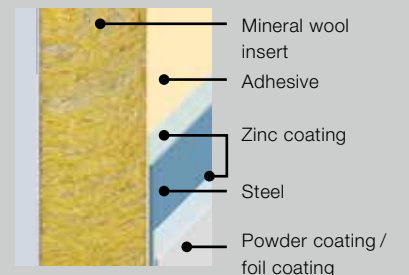

**Mineral wool insert** (optional) for better thermal insulation

### Optional extras Page 28



### Colours and decor surfaces Page 27

### Size range Page 30

# Additional equipment for an individual design

Glazing shapes for internal doors ZK and OIT 40



**Round glazing**  
Ø 300 or 400 mm,  
brushed stainless steel



**Glazing view 5**  
Anodised aluminium  
in natural finish  
(E6 / EV 1)



**Glazing view 6**  
Anodised aluminium  
in natural finish  
(E6 / EV 1)



**Glazing view 7**  
Anodised aluminium  
in natural finish  
(E6 / EV 1)



**Glazing view 8**  
Anodised aluminium  
in natural finish  
(E6 / EV 1)



**Glazing view 9**  
Anodised aluminium  
in natural finish  
(E6 / EV 1)

## Door glazing

All ZK and OIT 40 internal doors are available with glazing in the textures shown, with light 7 mm wired ornamental glass, 6 mm single-pane or laminated safety glass.

For on-site glazing, please note the pane thickness of 4 – 6 mm. Round glazing is only available from the factory.



Master-Point



Master-Carré

Optional extras for internal door  
ZK and OIT 40



Plastic ventilation grille  
(455 × 90 mm)



Wide-angle spyhole

Optional lever handle sets in various shapes  
and surfaces for internal door ZK and OIT 40



Lever / knob handle set  
with rose escutcheon,  
black or white plastic



Lever handle set with  
rose escutcheons  
in stainless steel



Lever / knob handle  
set with short  
escutcheon in natural  
finish anodised  
aluminium

# Preferred colours

Hörmann steel doors are available in inexpensive preferred colours and all RAL colours as well as high-quality decors. Surfaces are powder-coated with a primer (painted for external doors) which makes them especially resistant and durable.

● = Standard, ○ = Optional

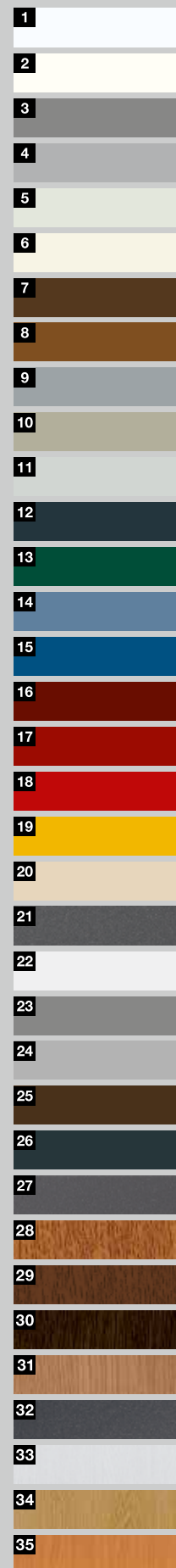

Preferred colours		KSI Thermo46, MZ Thermo65, MZ Thermo46	KSI 40-1	H3 OD	ZK, OIT 40	MZ, H8-5
1	RAL 9016 Traffic white (standard)	●	●	○	●	○
2	RAL 9010 Pure white			○		
3	RAL 9007 Grey aluminium	○		○		
4	RAL 9006 White aluminium	○	○		○	
5	RAL 9002 Grey white	○		●		●
6	RAL 9001 Cream	○				
7	RAL 8028 Terra brown	○	○		○	
8	RAL 8003 Clay brown	○	○		○	
9	RAL 7040 Window grey	○	○		○	
10	RAL 7035 Light grey	○	○	○	○	○
11	RAL 7032 Pebble grey					○
12	RAL 7016 Anthracite grey	○	○	○	○	○
13	RAL 6005 Moss green	○	○		○	
14	RAL 5014 Pigeon blue	○	○		○	
15	RAL 5010 Gentian blue	○				
16	RAL 3004 Purple red	○				
17	RAL 3003 Ruby red	○	○		○	
18	RAL 3000 Flame red	○		○		
19	RAL 1015 Light ivory	○	○		○	
20	RAL 1004 Golden yellow					○
21	CH 703 Anthracite metallic	○				
	RAL to choose		○	○	○	
<b>Matt deluxe ■ NEW</b>						
22	CH 9016 Matt deluxe Traffic white	○				
23	CH 9007 Matt deluxe Grey aluminium	○				
24	CH 9006 Matt deluxe White aluminium	○				
25	CH 8028 Matt deluxe Terra brown	○				
26	CH 7016 Matt deluxe Anthracite grey	○				
27	CH 703 Matt deluxe Anthracite metallic	○				
<b>Decors</b>						
28	Golden Oak, medium brown, golden yellow oak design	○	○		○	
29	Dark Oak, walnut-coloured oak decor	○	○		○	
30	Night Oak: dark, intense oak design	○	○		○	
31	Winchester Oak, natural-coloured knotty oak design	○	○		○	
32	Titan Metallic CH 703, with a metallic effect	○				
33	White Ash (only suitable for indoor use)		○		○	
34	Light Oak (only suitable for indoor use)		○		○	
35	Beech (only suitable for indoor use)		○		○	

All colours are based on RAL. The colours and surface finishes shown are subject to the limitations of the printing process and cannot be regarded as binding. Dark colours should not be used for doors that are exposed to the sun, as an increased material expansion may impair the door's function.

## Proven and inexpensive frames

Hörmann steel frames are especially robust and can withstand “accidents” with toy cars or run-ins with hard objects. The hot-galvanized and primed surface can be painted individually, letting you match it perfectly to the look of the steel or timber doors used. On request, the frames also come with a high-quality powder coating in any RAL colour.



## Product characteristics

**Corner and profile frames** for 40 mm thick rebated door leaves

**Ready-to-fit standard frames** galvanized and with powder-coated primer in Light grey (similar to RAL 7035)

### Versions

- Ready-to-fit and welded
- To screw or clamp

### Fitting in

- Brickwork
- Partition wall

### Corner or profile frame

Where do you want your internal door to be fitted? This question must be answered before you can select your frame. If installed in brickwork, in the basement for example, an inexpensive corner frame is all you need. However, for the living area we recommend a profile frame enveloping the wall. Partition wall frames are always designed as profile frames and are ideal for dry loft constructions.

### Welded or to screw or clamp

All Hörmann standard frames for brickwork or partition walls are ready-to-fit and welded or to screw or clamp. They come in a handy package that can be transported in a car and are already prepared for easy fitting by yourself.

### Variety is our strength

We have every frame you could possibly need. We offer door and window frames or passage frames between rooms. The frames are also available with segmental arches or Norman arches as well as in combination with a side element and transom light. All frames are additionally available in a final coating in any RAL colour or an elegant stainless steel version. We would be pleased to advise you.

### Flexible, long-lasting, elegant: VarioFix frame

For the Hörmann steel profile frame VarioFix, wall tolerances of up to 20 mm are no longer a problem: The adjustable decorative rebate compensates for different wall thicknesses during renovations and new construction projects. As easy to fit as a timber frame, the steel profile frame is additionally distinguished by its long service life and attractive design. Only VarioFix offers high resistance and an elegant shape coupled with the fitting principle of timber frames.

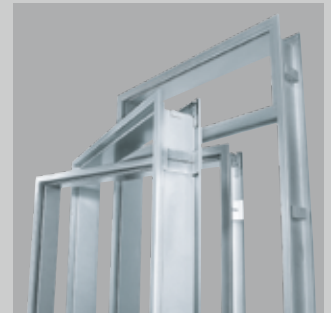

Corner and profile frames



Frame to screw or clamp



Profile frame VarioFix

Bottom image:

Sliding door frame for glass and timber doors running within the wall.



# STEEL DOORS SIZE RANGE

Standard sizes	External doors				Internal doors				
Ordering size (width × height)	Security door		Multi-purpose door		Fire-rated door	Fire-rated door	Fire-rated door	Internal door	Internal door
	KSI Thermo46	KSI 40-1	MZ Thermo46/ MZ Thermo65	MZ	H3 OD	H3 OD	H8-5	ZK	OIT 40
<b>Single-leaf doors</b>									
750 × 875							●		
800 × 800							●		
875 × 875							●		
875 × 1000							●		
875 × 1250							●		
625 × 2000								●	●
625 × 2125								●	●
750 × 1750				●			●		
750 × 1875		●		●			●	●	●
750 × 2000		●		●			●	●	●
750 × 2125		●						●	●
800 × 1800				●			●		
800 × 1875				●			●		
800 × 2000				●			●		
875 × 1750				●			●		
875 × 1800				●			●		
875 × 1875		●		●			●	●	●
875 × 2000	■	●	■	●	●	●	●	●	●
875 × 2125	■	●	■	●	●	●	●	●	●
1000 × 1875		●		●	●		●	●	●
1000 × 2000	■	●	■	●	●	●	●	●	●
1000 × 2100	■		■						
1000 × 2125	■	●	■	●	●	●	●	●	●
1000 × 2250					●	●			
1000 × 2500					●	●			
1100 × 2100	■		■						
1125 × 2000									
1125 × 2125				●	●	●		●	●
1250 × 2000				●	●	●		●	●
1250 × 2125				●	●	●		●	●
1250 × 2250					●	●			
1250 × 2500					●	●			
<b>Double-leaf doors</b>									
1500 × 2000				●		●		●	●
1500 × 2125					●	●		●	●
1500 × 2250						●			
1500 × 2500						●			
1750 × 2000				●	●	●		●	●
1750 × 2125								●	●
2000 × 2000				●	●	●		●	●
2000 × 2125				●	●	●		●	●
2000 × 2500					●	●			
2125 × 2125					●	●			
2250 × 2125					●	●			
2250 × 2250					●	●			
2500 × 2500					●	●			
2750 × 2500						●			
3000 × 2500						●			

Special sizes	External doors						
Ordering size	Security door		Multi-purpose door				Fire-rated door
	KSI Thermo46	KSI 40-1	MZ Thermo46 / MZ Thermo65			MZ	
			TPS 011 / THP 011	TPS 021	TPS 051 / THP 051		
<b>Single-leaf doors</b>							
Width	■ 832-1250	● 625-1250	■ 700-1250	■ 700-1250	■ 875-1250	● 625-1250	● 625-1250
Height	■ 1875-2250	● 1700-2250	■ 1750-2250	■ 1875-2250	■ 1875-2250	● 1570-2134	● 1750-2500
<b>Double-leaf doors</b>							
Width						● 1250-2250	● 1375-2500
Height						● 1570-2134	● 1750-2500

Special sizes	Internal doors			
Ordering size	Fire-rated door	Fire-rated door	Internal door	Internal door
	H3 OD	H8-5	ZK	OIT 40
<b>Hatch</b>				
Width		● 625-1000		
Height		● 800-1749		
<b>Single-leaf doors</b>				
Width	● 625-1500	● 625-1000	● 500-1250	● 625-1250
Height	● 1750-2500	● 1750-2125	● 1500-2250	● 1500-2250
<b>Double-leaf doors</b>				
Width	● 1375-3000		● 1500-2500	● 1500-2500
Height	● 1750-2500		● 1500-2250	● 1500-2250

Please state handing on order

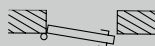

Left-hand hinged



Right-hand hinged

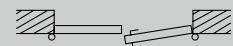

Traffic leaf right-hand hinged

All dimensions in mm

● = nominal size

■ = overall frame dimension

01933 229135

[www.thegaragedoorcentre.co.uk](http://www.thegaragedoorcentre.co.uk)

[enquiries@thegaragedoorcentre.co.uk](mailto:enquiries@thegaragedoorcentre.co.uk)

# STEEL DOOR DIMENSIONAL REFERENCES

Multi-purpose door MZ Thermo46 / MZ Thermo65, security door KSI Thermo46

## Vertical view

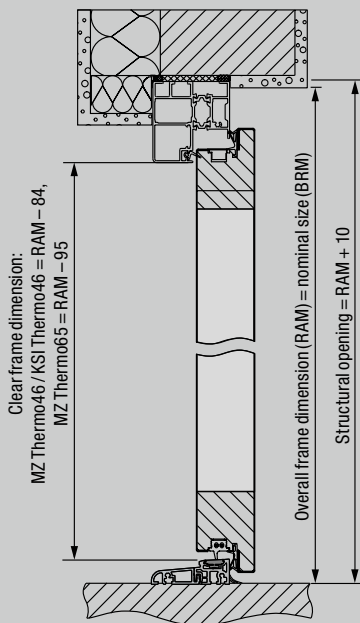

## Horizontal view

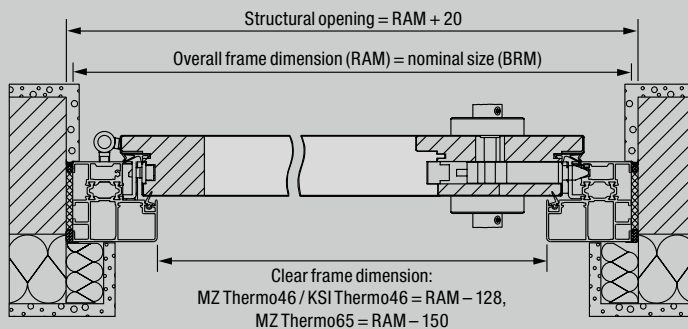

\* With an opening angle of  $90^\circ$  and without handles and levers, the clear passage width is reduced by 2 mm.

## Fitting versions

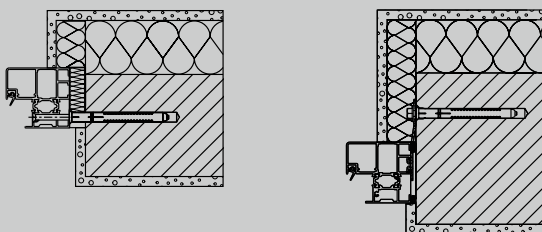

### Block frame

Fitting to brickwork  
 Countersunk fitting

### Block frame

Anchor fitting

Security door KSI 40-1

## Vertical view

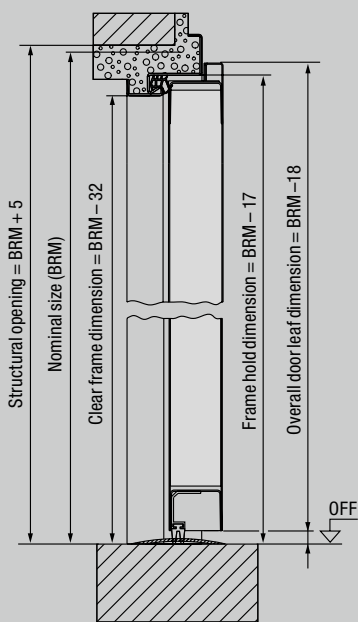

## Horizontal view

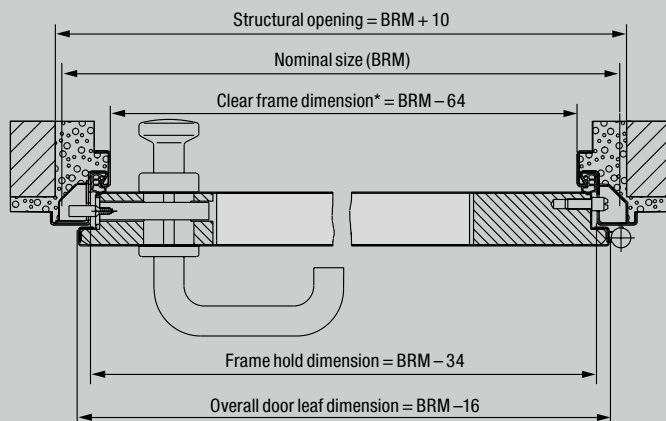

\* With an opening angle of  $90^\circ$  and without handles and levers, the clear passage width is reduced by 2 mm.

## Fitting versions

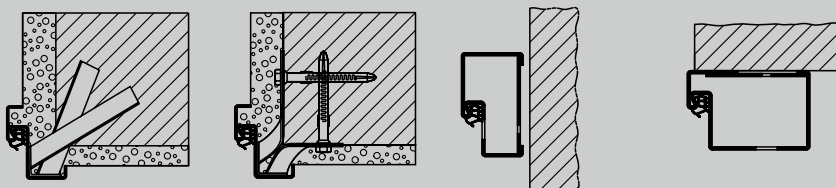

Fitting with  
 through plugs

Fitting with  
 grouting lugs

Block frame for fitting  
 in the opening  
 (profile 21101)

Block frame for fitting  
 to the wall (profile 006)  
 (tested on the closing side)



# STEEL DOOR DIMENSIONAL REFERENCES

## Multi-purpose door MZ, fire-rated door H8-5

### Vertical view

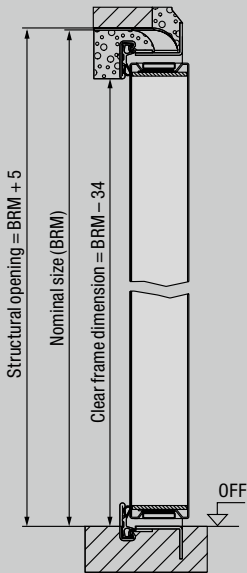

### Horizontal view

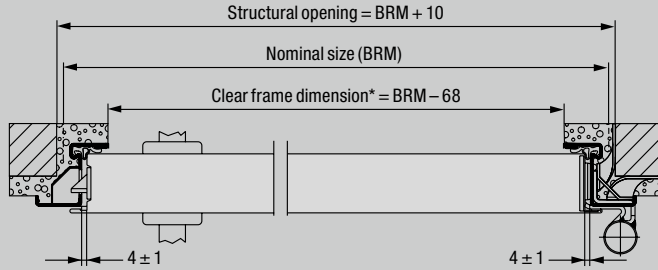

\* With an opening angle of 90° and without handles and levers, the clear passage width is reduced by 25 mm.

### Fitting versions

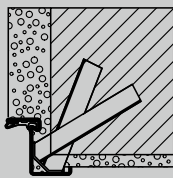

Fitting with through plugs

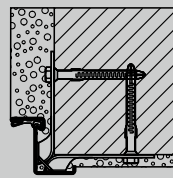

Fitting with grouting lugs

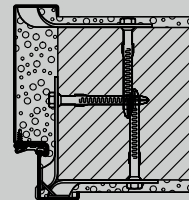

**Corner and counter frame**  
Fitting with grouting lugs

## Fire-rated door H3 OD

### Vertical view

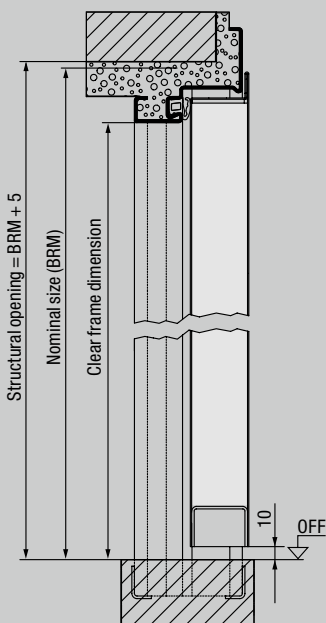

### Horizontal views

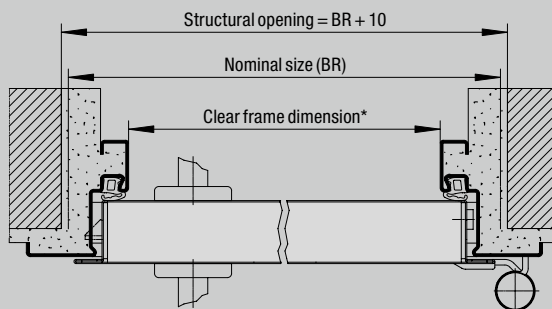

\* With an opening angle of 90° and without handles and levers, the clear passage width is reduced by 113 mm (thin rebate) or 103 mm (thick rebate).

### Fitting versions

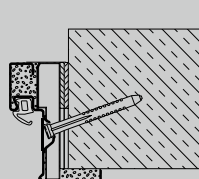

**Diagonal fixing**  
(Unplastered brickwork / concrete)

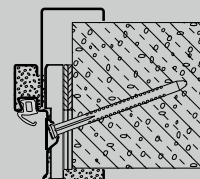

**Diagonal fixing**  
with the Vario B53 counter frame as a double-shell profile frame (gas concrete)

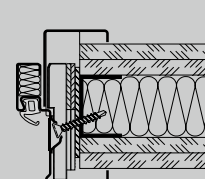

**Diagonal fixing**  
(Gas concrete)

All dimensions in mm

# STEEL DOOR DIMENSIONAL REFERENCES

## Internal door ZK

### Vertical view

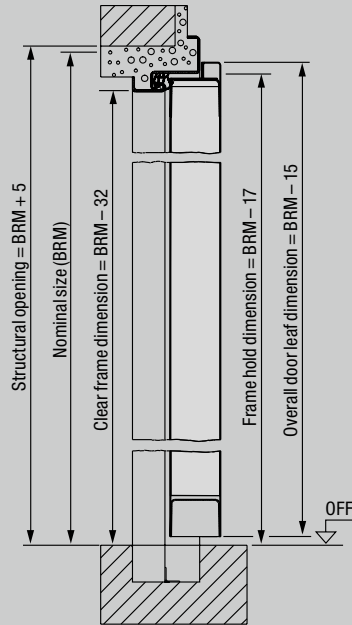

### Horizontal view

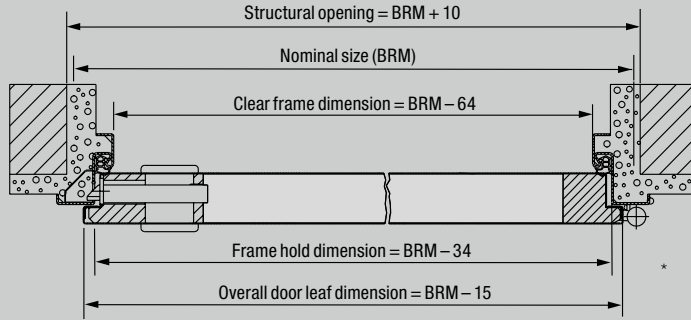

\* Clear frame dimension = BR width - 64 mm, BR height - 32 mm. With an opening angle of 90° and without handles and levers, the clear passage width is reduced by 2 mm.

### Fitting versions

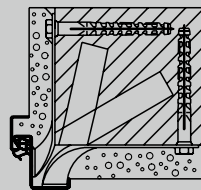

**Corner frame**  
Fitting to brickwork  
Grouting lugs

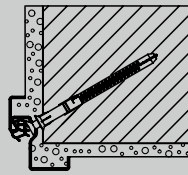

**Special corner frame**  
Plug-and-screw fitting through the groove bottom

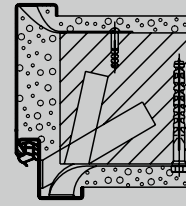

**Profile frame**  
Fitting to brickwork  
Grouting lugs

## Internal door OIT 40

### Vertical view

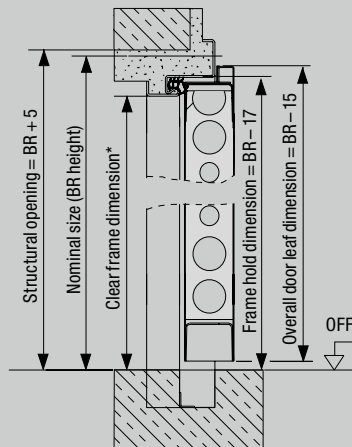

### Horizontal view

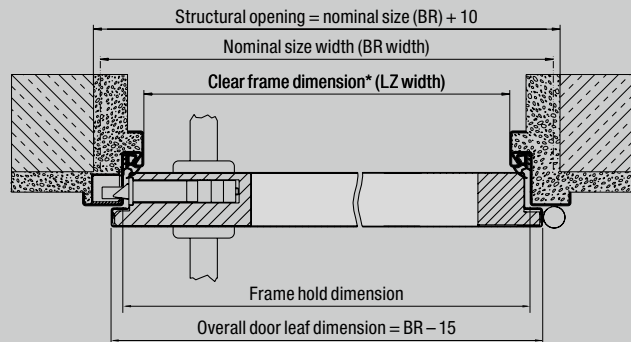

\* Clear frame dimension = BR width - 64 mm, BR height - 32 mm. With an opening angle of 90° and without handles and levers, the clear passage width is reduced by 2 mm.

### Fitting versions

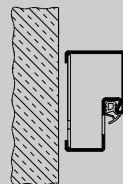

**Block frame**  
With fixing brackets for fitting in the opening (profile 21101)

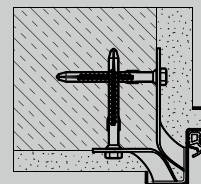

Fitting with through plugs (Plug-and-screw fitting)

# FRAME SIZE RANGE AND WALL CONNECTIONS

Frames	Corner frame	Profile frame
Ordering size (nominal size)		
625 × 2000	●	●
750 × 2000	●	●
875 × 2000	●	●
1000 × 2000	●	●
625 × 2125	●	●
750 × 2125	●	●
875 × 2125	●	●
1000 × 2125	●	●

Profile frame	Brickwork	Partition wall	Gypsum plasterboard
Wall widths (MW)			
75		●	
80	●		●
100	●	●	●
125		●	
130	●		
145	●		
150		●	
160	●		
180	●		
205	●		
270	●		
290	●		
330	●		

Corner frame DIN 18111 for brickwork

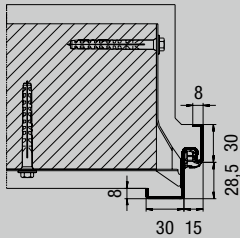

Profile 11100

Profile frame DIN 18111 for brickwork

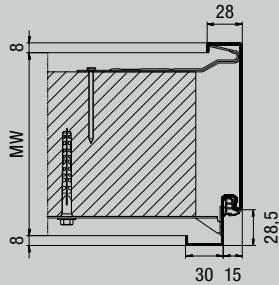

Profile 21100

Profile frame B 45 for gypsum plasterboard

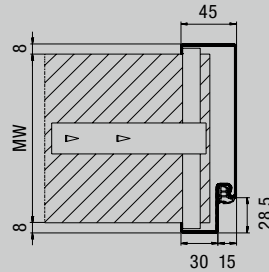

Profile 21101

Profile frame for partition walls

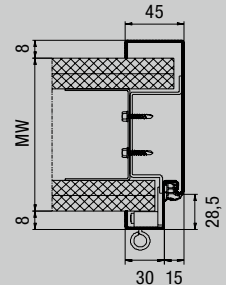

Profile 21120

Profile knock-down frame for partition walls 3-part for retrofitting

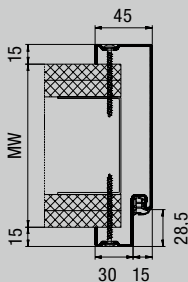

Profile 21120, screw fixing through frame face

Double-shell profile frame for partition walls For retrofitting

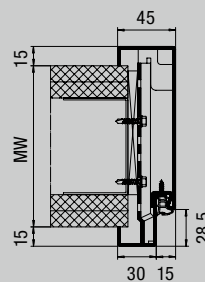

Profile 21180, rebated

Steel profile frame VarioFix for all wall types For retrofitting

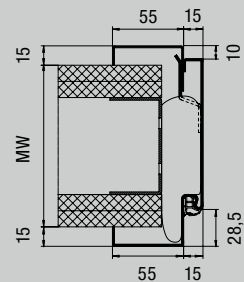

Profile 31103, rebated

All dimensions in mm



# Discover a new feeling of home: high-quality residential doors

Hörmann residential doors give your home an extra level of comfort. Hörmann offers a comprehensive range of beautiful door designs, various handle variants and a selection of surfaces. For example, the particularly impact-resistant Duradecor surface finish will convince you due to ease of care and robustness.

Whether classic or modern, white lacquer or real wood veneer, with glass elements or stainless steel embellishments or as an all-glass door matching the DesignLine timber doors – Hörmann offers you the residential door that suits you and your furnishings perfectly.



Residential door BaseLine



Residential door DesignLine and all-glass doors



Residential door with panel design



Residential doors ConceptLine



You can find more information in our "Residential doors" brochure.



# Experience Hörmann quality in new construction and modernisation

Hörmann provides an excellent basis for comprehensive planning. Carefully matched solutions offer you the very best in perfectly designed products for every area.

- **Garage doors**

Optimally match your personal architectural style: up-and-over or sectional doors made of steel or timber.

- **Gate and Door Operators**

Enjoy extra convenience and break-in-resistant security with Hörmann operators for garage doors and entrance gates. You can profit from the convenience of Hörmann door operators in your residential space as well.

- **Entrance doors**

Our comprehensive entrance door ranges include models that fit almost every need and requirement.

- **Residential internal doors**

Our high-quality timber and glass doors give your home an extra level of comfort and integrate harmoniously into the overall appearance of your home.

- **Steel doors**

Sturdy doors for your entire home, from basement to roof.

- **Frames**

Choose from our comprehensive range of products for new construction, expansion and modernisation.



Garage doors and entrance gate operators



Entrance doors



Steel doors