



Sectional garage doors

Technical Manual
Status 07.2017

Contents

Contents	Page
Door type/door leaf	3–4
Door type/door leaf	4
LTE 42, S-ribbed, Woodgrain	5
LTE 42, M-ribbed, Woodgrain	6
LTE 42, S-panelled, Woodgrain	7
LPU 42, S-ribbed, Woodgrain	8
LPU 42, M-ribbed, Woodgrain	9
LPU 42, M-ribbed, Sandgrain, Silkgrain or Decograin	10
LPU 42, L-ribbed, Woodgrain	11
LPU 42, L-ribbed, Sandgrain, Micrograin, Silkgrain or Decograin	12
LPU 42, D-ribbed, T-ribbed, Silkgrain	13
LPU 42, S-panelled, Woodgrain	14
LPU 42, S-panelled, Decograin	15
LPU 67 Thermo, M-, L-ribbed, Silkgrain or Decograin	16
Sunrise glazing LTE 42 / LPU 42	17
Design element LPU 42, L-ribbed	18
Design element LPU 42, T-ribbed	19
LPU 42 with wicket door with trip-free threshold, S, M, L-ribbed, Woodgrain, Sandgrain, Micrograin, Silkgrain or Decograin	20
LPU 42 with wicket door with trip-free threshold, S, M, L-ribbed, matching exterior view for doors with glazing	21
LPU 42 with wicket door with trip-free threshold, S-panelled, Woodgrain or Decograin	22
LPU 42 with wicket door with trip-free threshold, arrangement of the wicket door	23
LPU 42 with wicket door and threshold rail, S-, M-, L-, D-, T-ribbed, Woodgrain, Sandgrain, Micrograin, Silkgrain or Decograin	24
LPU 42 with wicket door and threshold rail, S-panelled, Woodgrain or Decograin	25
LTH 42, S, M, L-ribbed, V-panelled	26
LTH 42 with special designs	27
LPU 42, S-ribbed, Woodgrain, fitting in front of the reveal	28
LPU 42, M-ribbed, Woodgrain or Silkgrain, fitting in front of the reveal	29
LPU 42, L-ribbed, Woodgrain or Silkgrain, fitting in front of the reveal	30
LPU 42, S-panelled, Woodgrain, fitting in front of the reveal	31
Track application Z	32
Track application N	33
Track application L	34
Track application H	35
Track application N with wicket door with trip-free threshold	36
Track application L with wicket door with trip-free threshold	37
Track application N with wicket door and threshold rail	38
Track application L with wicket door and threshold rail	39
Track application BZ	40
Track application BL	41
Track application BL with wicket door with trip-free threshold	42
Track application Z, fitting in front of the reveal	43
Sideroom	44
Sideroom and lintel fitting with ThermoFrame	45
Sideroom, fitting in front of the reveal	46
Lintel fitting with fascia panels	47
Bottom edge	48–49
Fixed Elements	50
Side doors NT 60 with corner frames made of aluminium profiles, standard and special sizes	51–52
Side doors NT 60 with block frames made of aluminium profiles, standard sizes	53–54
Side doors NT 60 with block frames made of aluminium profiles, special sizes	55–56
Double-leaf side doors NT 60 with block frames made of aluminium profiles	57
Timber side doors NT 60, standard sizes/special sizes	58

Please always take the country-specific building regulations into account!
 Door leaf constructions and track applications as well as fitting examples are provided in this manual.
 Before fitting a sectional door, the structural opening must be finished and the garage floor must be laid and level.

No part may be reproduced without our prior permission.
 All rights reserved.
 All dimensions in mm.
 Subject to design changes.

Door type	Door leaf
Sectional door LTE 42 – single-skinned steel sections	
<ul style="list-style-type: none"> • S-ribbed Woodgrain • M-ribbed Woodgrain 	<ul style="list-style-type: none"> • Single-skinned door sections, Woodgrain-embossed • Equal-height door sections, horizontally ribbed, in hot-galvanized sheet steel • Surface with polyester-primer coating
<ul style="list-style-type: none"> • S-panelled Woodgrain 	<ul style="list-style-type: none"> • Single-skinned door sections, Woodgrain-embossed • Hot-galvanized sheet steel door sections of equal height with panelling • Surface with polyester-primer coating
Sectional door LPU 42 – double-skinned steel sections	
<ul style="list-style-type: none"> • S-ribbed Woodgrain • M-ribbed Woodgrain, Sandgrain, Silkgrain or Decograin • L-ribbed Woodgrain, Sandgrain, Micrograin, Silkgrain or Decograin • D- and T-ribbed Silkgrain 	<ul style="list-style-type: none"> • Double-skinned, PU-foamed door sections, Woodgrain, Sandgrain, Micrograin, Silkgrain or Decograin exterior, Stucco-textured interior • Hot-galvanized sheet steel door sections of equal height with horizontal ribbing or without ribbing • Surface with polyester-primer coating (with Decograin, plastic film coating on the outside)
<ul style="list-style-type: none"> • S-panelled Woodgrain or Decograin 	<ul style="list-style-type: none"> • Double-skinned, PU-foamed door sections, Woodgrain or Decograin-embossed exterior, Stucco-textured interior • Hot-galvanized sheet steel door sections of equal height with panelling • Surface with polyester-primer coating (with Decograin, plastic film coating on the outside)
Fitting in front of the reveal <ul style="list-style-type: none"> • S-ribbed Woodgrain • M-ribbed, Woodgrain or Silkgrain • L-ribbed, Woodgrain or Silkgrain • D- and T-ribbed Silkgrain 	<ul style="list-style-type: none"> • Double-skinned, PU-foamed door sections, Woodgrain or Silkgrain exterior, Stucco-textured interior • Hot-galvanized sheet steel door sections of equal height with horizontal ribbing or without ribbing • Surface with polyester-primer coating
Fitting in front of the reveal <ul style="list-style-type: none"> • S-panelled Woodgrain 	<ul style="list-style-type: none"> • Double-skinned, PU-foamed door sections, Woodgrain-embossed exterior, Stucco-textured interior • Hot-galvanized sheet steel door sections of equal height with panelling • Surface with polyester-primer coating
Sectional door LPU 67 Thermo – double-skinned steel sections with thermal break	
<ul style="list-style-type: none"> • M-ribbed Silkgrain or Decograin • L-ribbed Silkgrain or Decograin 	<ul style="list-style-type: none"> • Double-skinned, PU-foamed door sections, with thermal break, Silkgrain or Decograin exterior, Stucco-textured interior • Hot-galvanized sheet steel door sections of equal height with horizontal ribbing or without ribbing • Surface with polyester-primer coating (with Decograin, plastic film coating on the outside)
Sectional door LPU 42 with wicket door – double-skinned steel sections	
<ul style="list-style-type: none"> • M-ribbed Silkgrain or Decograin • L-ribbed Silkgrain or Decograin 	<ul style="list-style-type: none"> • Double-skinned, PU-foamed door sections, Woodgrain, Sandgrain, Micrograin, Silkgrain or Decograin exterior, Stucco-textured interior • Hot-galvanized sheet steel door sections of equal height with horizontal ribbing or without ribbing • Surface with polyester-primer coating (with Decograin, plastic film coating on the outside) • Without door handle set, without inside locking, without single-skinned steel fascia, without design elements, upper door section with lintel seal • We recommend fitting a garage door operator SupraMatic P.
<ul style="list-style-type: none"> • S-panelled Woodgrain or Decograin 	<ul style="list-style-type: none"> • Double-skinned, PU-foamed door sections, Woodgrain or Decograin-embossed exterior, Stucco-textured interior • Hot-galvanized sheet steel door sections of equal height with panelling • Surface with polyester-primer coating • Without door handle set, without inside locking, without single-skinned steel fascia, upper door section with lintel seal • We recommend fitting a garage door operator SupraMatic P.

Further details can be obtained in the brochure.

Door type	Door leaf
Sectional Door LTH 42	
<ul style="list-style-type: none"> • S-ribbed, Nordic Pine/Hemlock • M-ribbed, Nordic Pine/Hemlock • L-ribbed, Nordic Pine/Hemlock • V-panelled, Nordic Pine/Hemlock 	<ul style="list-style-type: none"> • Solid timber door sections, S, M, L-ribbed or V-panelled • Door sections of equal height • Surface impregnated against blue stain and wood pests • Glazings not possible in the two bottom door sections
Sectional door LTH 42 with special designs	
Nordic Pine/Hemlock	<ul style="list-style-type: none"> • Solid timber sections with different door styles • Door sections of equal height • Surface impregnated against blue stain and wood pests • Door styles 403 and 404 with natural stone infill on request
Side doors with corner frames made of aluminium profiles	
Standard sizes	<ul style="list-style-type: none"> • Appearance same as LTE 42/LPU 42, leaf frame made of aluminium extrusions, depth 60 mm • PU-foamed steel-section door infill, Woodgrain, Sandgrain, Micrograin, Silkgrain or Decograin exterior, Stucco-textured interior • Surface with polyester-primer coating (with Decograin, plastic film coating on the outside)
Side doors with block frames made of aluminium profiles	
Standard/special sizes	<ul style="list-style-type: none"> • Appearance same as LTE 42/LPU 42, leaf frame and frame made of aluminium extrusions (without thermal break), depth 60 mm, double buffer sealing on 3 sides • PU-foamed steel-section door infill, Woodgrain, Sandgrain, Micrograin, Silkgrain or Decograin exterior, Stucco-textured interior • Surface with polyester-primer coating (with Decograin, plastic film coating on the outside)
Timber Side Doors	
Standard/special sizes	<ul style="list-style-type: none"> • Appearance same as LTH 40 • Solid timber door leaf and frame, Nordic Pine or Hemlock; door leaf depth 42 mm, buffer sealing on 3 sides • Double seal in threshold area • Surface impregnated against blue stain and wood pests

Further details can be obtained in the brochures.

Sectional Door LTE 42

Single-skinned steel sections

S-ribbed

Woodgrain

External views

(The illustrations correspond to size 2500 × 2125 mm. Deviations may occur with other door sizes.)

Basic model

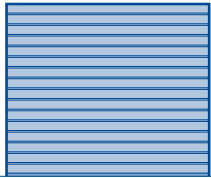

With aluminium frame

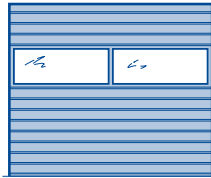

With glazing

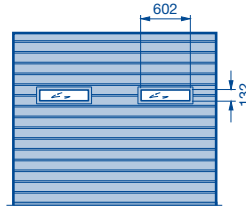

Note:

Different glazing arrangements are not possible!

Size range

Door width in 1 mm increments, door height in grid height. Intermediate heights are not possible.

		A	B	C										
RM	3000	6	500	125										
	2875	6	479	120										
	2750	5	550	138										
	2625	5	525	131										
	2500	5	500	125										
	2375	5	475	119										
	2250	4	562	141										
	2205	4	550	138										
	2125	4	531	133										
	2080	4	520	130										
	2000	4	500	125										
	1955	4	488	122										
	1875	4	468	117										
		Number of infills per door section with glazing												
		2	3	4	5									
		2250	2375	2500	2750	3000	3250	3500	3750	4000	4250	4500	4750	5000
		LZ												

Doors up to 3000 × 2625 mm with tension spring assembly

A No. of door sections

B Door section height

C Spacing

RM Grid height

LZ Clear frame dimensions (from 2000)

Special equipment

Ventilation

- Ventilation slots in bottom door section, ventilation cross section 65 cm² for one metre door width
- Ventilation slots in bottom seal, ventilation cross section 65 cm² for one metre door width
- Aluminium frame with expanded mesh, 58 % ventilation cross section

Glazing options

- Aluminium frame (standard profile NF)
- Glazing type D, 3 mm

Sectional Door LTE 42

Single-skinned steel sections

M-ribbed

Woodgrain

External views

(The illustrations correspond to size 2500 × 2125 mm. Deviations may occur with other door sizes.)

Basic model



With aluminium frame



With glazing

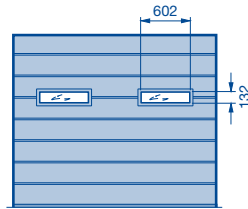

Note:

Different glazing arrangements are not possible!

Size range

Door width in 1 mm increments, door height in grid height. Intermediate heights are not possible.

													A	B	C					
RM	3000														6	500	250			
	2875														6	479	239			
	2750														5	550	275			
	2625														5	525	262			
	2500														5	500	250			
	2375														5	475	237			
	2250														4	562	281			
	2205														4	550	275			
	2125														4	531	265			
	2080														4	520	260			
	2000														4	500	250			
	1955														4	488	244			
	1875														4	468	234			
		2		3														Number of infills per door section with glazing		
		2250	2375	2500	2750	3000	3250	3500	3750	4000	4250	4500	4750	5000						
		LZ																		

 Doors up to 3000 × 2625 mm with tension spring assembly

A No. of door sections

B Door section height

C Spacing

RM Grid height

LZ Clear frame dimensions (from 2000)

Special equipment

Ventilation

- Ventilation slots in bottom door section ventilation cross section 65 cm² for one metre door width
- Ventilation slots in bottom seal, ventilation cross section 65 cm² for one metre door width
- Aluminium frame with expanded mesh, 58 % ventilation cross section

Glazing options

- Aluminium frame (standard profile NF)
- Glazing type D, 3 mm

Sectional Door LTE 42

Single-skinned steel sections

S-panelled

Woodgrain

External views

(The illustrations correspond to size 2500 × 2125 mm. Deviations may occur with other door sizes.)

Basic model

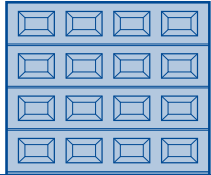

Style S0

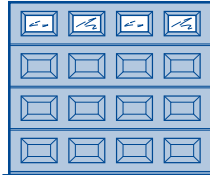

Style S1 with decorative rail (rhombus)

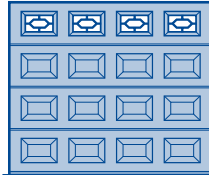

Style S2 with decorative rail (cross)

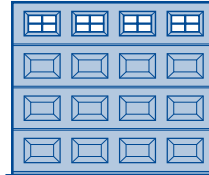

Style S10

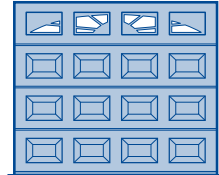

Size range

Door width in 1 mm increments, door height only in one of the grid heights shown. Intermediate heights are not possible.

														A	B		
RM	3000															6	500
	2875															6	479
	2750															5	550
	2625															5	525
	2500															5	500
	2375															5	475
	2250															4	562
	2205															4	550
	2125															4	531
	2080															4	520
	2000															4	500
	1955															4	488
	1875															4	468
		3 → 2070	4 → 2740	5											Number of panels per door section		
		2250	2375	2500	2750	3000	3250	3500	3750	4000	4250	4500	4750	5000			
		LZ															

 Doors up to 3000 × 2625 mm with tension spring assembly

A No. of door sections
B Door section height

RM Grid height
LZ Clear frame dimensions (from 2000)
→ Up to width

Special equipment

Ventilation

- Ventilation slots in bottom door section, ventilation cross section 65 cm² for one metre door width
- Ventilation slots in bottom seal, ventilation cross section 65 cm² for one metre door width

Glazing options – Panel glazing

Clear or crystal structure panes, 3 mm

- Designs S0, S1, S2
- Designs S10, S20 (see page 17)

Sectional Door LPU 42

Double-skinned steel sections

S-ribbed

Woodgrain

External views

(The illustrations correspond to size 2500 × 2125 mm. Deviations may occur with other door sizes.)

Basic model

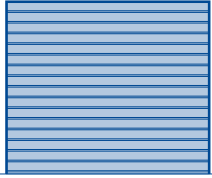

With aluminium frame NF/WF

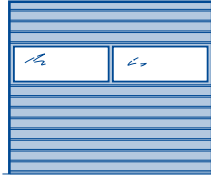

With glazing

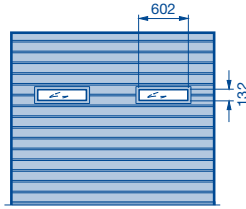

Size range

Door width in 1 mm increments, door height in grid height. Intermediate heights possible up to LZ = 5500 mm. All grid heights also possible in special 125 mm S-ribbed version (to produce doors with matching appearance with different RM).

		A	B	C	F		
RM	3000	6	500	125	2880 – 2920		
	2875	6	479	120	2755 – 2800		
	2750	5	550	138	2630 – 2655		
	2625	5	525	131	2505 – 2535		
	2500	5	500	125	2380 – 2420		
	2375	5	475	119	2255 – 2300		
	2250	4	562	141			
	2205	4	550	138			
	2125	4	531	133			
	2080	4	520	130			
	2000	4	500	125			
	1955	4	488	122			
	1875	4	468	117			
		4	6	8	10	12	No. of ventilation grilles with 40 cm ² ventilation cross section each
		2	3	4	5	6	Number of infills per door section with glazing
		2250	2375	2500	2750	3000	LZ
		2250	2375	2500	2750	3000	
		3250	3500	3750	4000	4250	
		4500	4750	5000	5250	5500	
		5750	6000				

 Doors up to 3000 × 2625 mm with tension spring assembly

A No. of door sections
B Door section height

C Spacing
F This range cannot be shortened (intermediate heights)
RM Grid height

LZ Clear frame dimensions (from 2000)

Special equipment

Ventilation

- Ventilation slots in bottom seal, ventilation cross section 65 cm² for one metre door width
- Ventilation grille, ventilation cross section 40 cm² each
- Aluminium frame with expanded mesh, 58 % ventilation cross section

Glazing options

- Aluminium frame (standard profile NF or thermal break profile WF)
- Glazing type D, 16 mm

Sectional Door LPU 42

Double-skinned steel sections

M-ribbed

Woodgrain

External views

(The illustrations correspond to size 2500 × 2125 mm. Deviations may occur with other door sizes.)

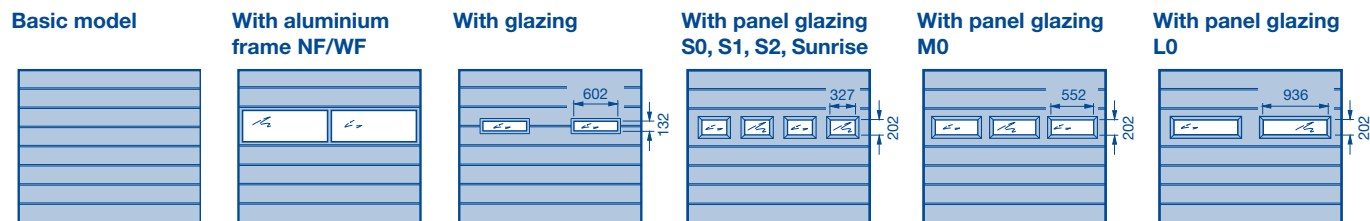

Size range

Door width in 1 mm increments, door height in grid height. Intermediate heights are possible up to LZ = 5500 mm.

RM													A	B	C			
	3000													6	500	250		
2875													6	479	239			
2750													5	550	275			
2625													5	525	262			
2500													5	500	250			
2375													5	475	237			
2250													4	562	281			
2205													4	550	275			
2125													4	531	265			
2080													4	520	260			
2000													4	500	250			
1955													4	488	244			
1875													4	468	234			
		4		6		8		10		12	No. of ventilation grilles with 40 cm ² ventilation cross section each							
		2		3		4		5		6	No. of glazings – aluminium frame and type D							
	3 → 2125	4		5		6		7		8	9	No. of glazings – type S						
	2 → 2240	3 → 2970		4 → 3690		5 → 4420		6 → 5140		7	8	No. of glazings – type M						
		2 → 3400		3 → 4490		4		5	No. of glazings – type L									
		2250	2375	2500	2750	3000	3250	3500	3750	4000	4250	4500	4750	5000	5250	5500	5750	6000
		LZ																

Doors up to 3000 × 2625 mm with tension spring assembly

A No. of door sections

B Door section height

C Spacing

RM Grid height

LZ Clear frame dimensions (from 2000)

→ Up to width

Special equipment

Ventilation

- Ventilation slots in bottom seal, ventilation cross section 65 cm² for one metre door width
- Ventilation grille, ventilation cross section 40 cm² each
- Aluminium frame with expanded mesh, 58 % ventilation cross section

Glazing options

- Aluminium frame (standard profile NF or thermal break profile WF)
- Glazing type D, 16 mm
- Panel glazing type S, M or L, 22 mm

Sectional Door LPU 42

Double-skinned steel sections

M-ribbed

Sandgrain, Silkgrain or Decograin

External views

(The illustrations correspond to size 2500 × 2125 mm. Deviations may occur with other door sizes.)

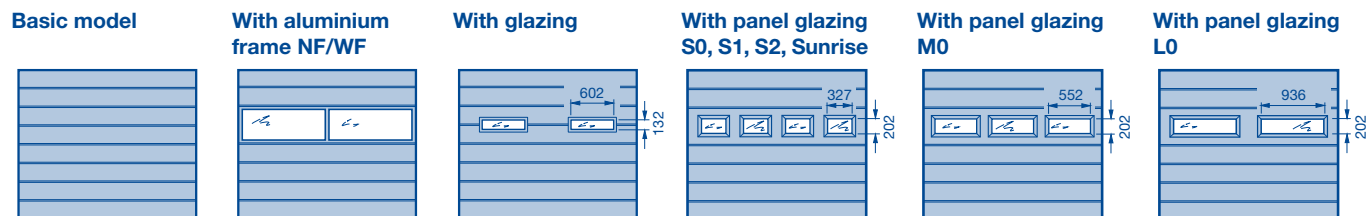

Size range

Door width in 1 mm increments up to LZ = 5500 mm, door height in grid height. Intermediate heights are possible.

														A	B	C							
RM	3000																6	500	250				
	2875																	5	550	275			
	2750																	5	550	275			
	2625																	5	550	275			
	2500																	5	500	250			
	2375																	5	475	237			
	2250																	4	562	281			
	2205																	4	550	275			
	2125																	4	531	265			
	2080																	4	520	260			
	2000																	4	500	250			
	1955																	4	488	244			
	1875																	4	468	234			
		4		6		8		10		12		No. of ventilation grilles with 40 cm ² ventilation cross section each											
		2		3		4		5		6		No. of glazings – aluminium frame and type D											
	3 → 2125	4		5		6		7		8		9		No. of glazings – type S									
	2 → 2240	3 → 2970			4 → 3690			5 → 4420			6 → 5140			7		8		No. of glazings – type M					
		2 → 3400				3 → 4490				4				5		No. of glazings – type L							
		2250	2375	2500	2750	3000	3250	3500	3750	4000	4250	4500	4750	5000	5250	5500	5750	6000	LZ				

Doors up to 3000 × 2625 mm with tension spring assembly

A No. of door sections

B Door section height

C Spacing

RM Grid height

LZ Clear frame dimensions (from 2000)

→ Up to width

● Door size not possible for Silkgrain

Special equipment

Ventilation

- Ventilation slots in bottom seal, ventilation cross section 65 cm² for one metre door width
- Ventilation grille, ventilation cross section 40 cm² each
- Aluminium frame with expanded mesh, 58 % ventilation cross section

Glazing options

- Aluminium frame (standard profile NF or thermal break profile WF)
- Glazing type D, 16 mm
- Panel glazing type S, M or L, 22 mm

Sectional Door LPU 42

Double-skinned steel sections

L-ribbed

Woodgrain

External views

(The illustrations correspond to size 2500 × 2125 mm. Deviations may occur with other door sizes.)

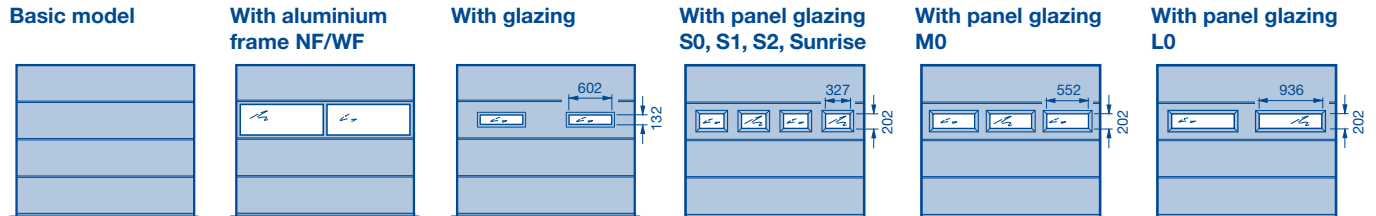

Size range

Door width in 1 mm increments, door height in grid height. Intermediate heights are possible up to LZ = 5500 mm.

RM													A	B	C			
	3000													6	500	250		
2875													6	479	239			
2750													5	550	275			
2625													5	525	262			
2500													5	500	250			
2375													5	475	237			
2250													4	562	281			
2205													4	550	275			
2125													4	531	265			
2080													4	520	260			
2000													4	500	250			
1955													4	488	244			
1875													4	468	234			
		4		6		8		10		12	No. of ventilation grilles with 40 cm ² ventilation cross section each							
		2		3		4		5		6	No. of glazings – aluminium frame and type D							
	3 → 2125	4		5		6	7	8		9	No. of glazings – type S							
	2 → 2240	3 → 2970		4 → 3690		5 → 4420	6 → 5140	7		8	No. of glazings – type M							
		2 → 3400		3 → 4490		4		5	No. of glazings – type L									
		2250	2375	2500	2750	3000	3250	3500	3750	4000	4250	4500	4750	5000	5250	5500	5750	6000
		LZ																

Doors up to 3000 × 2625 mm with tension spring assembly

A No. of door sections

B Door section height

C Spacing

RM Grid height

LZ Clear frame dimensions (from 2000)

→ Up to width

Special equipment

Ventilation

- Ventilation slots in bottom seal, ventilation cross section 65 cm² for one metre door width
- Ventilation grille, ventilation cross section 40 cm² each
- Aluminium frame with expanded mesh, 58 % ventilation cross section

Glazing options

- Aluminium frame (standard profile NF or thermal break profile WF)
- Glazing type D, 16 mm
- Panel glazing type S, M or L, 22 mm

Sectional Door LPU 42

Double-skinned steel sections

L-ribbed

Sandgrain, Micrograin, Silkgrain or Decograin

External views

(The illustrations correspond to size 2500 × 2125 mm. Deviations may occur with other door sizes.)

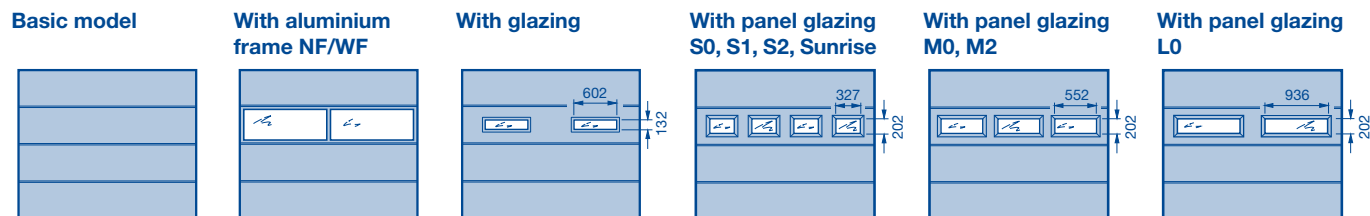

Size range

Door width in 1 mm increments, door height in grid height. Intermediate heights are possible up to LZ = 5500 mm.

														A	B				
RM	3000																6	500	
	2875																		
	2750																	5	550
	2625																		
	2500																	5	500
	2375																	5	475
	2250																	4	562
	2205																	4	550
	2125																	4	531
	2080																	4	520
	2000																	4	500
	1955																	4	488
	1875																	4	468
		4		6		8		10		12		No. of ventilation grilles with 40 cm ² ventilation cross section each							
		2		3		4		5		6		No. of glazings – aluminium frame and type D							
	3 → 2125	4		5		6		7		8		9		No. of glazings – type S					
	2 → 2240	3 → 2970		4 → 3690		5 → 4420		6 → 5140		7		8		No. of glazings – type M					
		2 → 3400				3 → 4490				4		5		No. of glazings – type L					
		2250	2375	2500	2750	3000	3250	3500	3750	4000	4250	4500	4750	5000	5250	5500	5750	6000	
		LZ																	

- Doors up to 3000 × 2625 mm with tension spring assembly
- A** No. of door sections
- B** Door section height
- RM** Grid height
- LZ** Clear frame dimensions (from 2000)
- Up to width
- Door size not possible for Silkgrain

Special equipment

Ventilation

- Ventilation slots in bottom seal, ventilation cross section 65 cm² for one metre door width
- Ventilation grille, ventilation cross section 40 cm² each
- Aluminium frame with expanded mesh, 58 % ventilation cross section

Glazing options

- Aluminium frame (standard profile NF or thermal break profile WF)
- Glazing type D, 16 mm
- Panel glazing type S, M or L, 22 mm

Sectional Door LPU 42

Double-skinned steel sections

D-ribbed, T-ribbed

Silkgrain

External views

(The illustrations correspond to size 2500 × 2125 mm. Deviations may occur with other door sizes.)

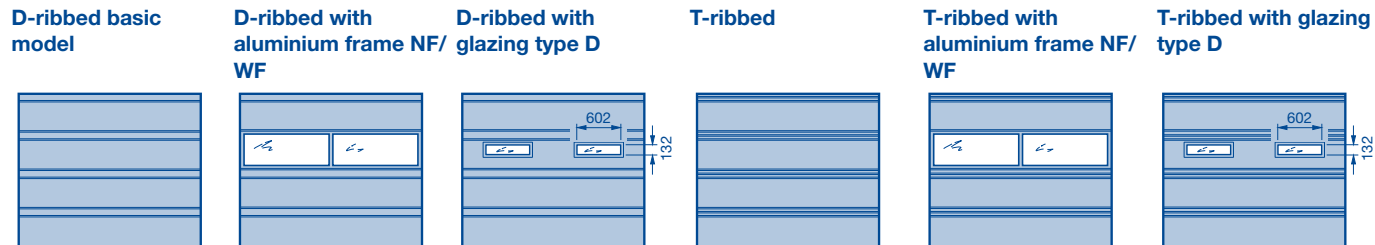

Size range

Door width in 1 mm increments, door height in grid height. Intermediate heights are possible up to LZ = 5500 mm.

							A	B	F (D-ribbed)	F (T-ribbed)										
RM	3000						6	500	2895–2930 2755–2870	2950–2985 2895–2930 2755–2870										
	2875																			
	2750						5	550	2645–2680 2505–2570	2700–2735 2645–2680 2505–2570										
	2625																			
	2500						5	500	2395–2430	2450–2485 2380–2430										
	2375											5	475	2255–2305	2325–2360 2255–2305					
	2250						4	562		2210–2235										
	2205											4	550	2130	2150–2185 2130–2135					
	2125						4	531		2085–2110										
	2080											4	520	2005–2010	2030–2065 2005–2010					
	2000						4	500		1960–1985										
	1955											4	488	1880–1885	1900–1940 1880–1885					
1875						4	468	1805–1880	1820–1860 1800–1805											
		4	6	8	10	12	No. of ventilation grilles with 40 cm ² ventilation cross section each													
		2	3	4	5	6	No. of glazings – aluminium frame and type D													
		2250	2375	2500	2750	3000	3250	3500	3750	4000	4250	4500	4750	5000	5250	5500	5750	6000		
		LZ																		

Doors up to 3000 × 2625 mm with tension spring assembly

A No. of door sections

B Door section height

F This range cannot be shortened (intermediate heights)

RM Grid height

LZ Clear frame dimensions (from 2000)

→ Up to width

Special equipment

Ventilation

- Ventilation slots in bottom seal, ventilation cross section 65 cm² for one metre door width
- Ventilation grille, ventilation cross section 40 cm² each
- Aluminium frame with expanded mesh, 58 % ventilation cross section

Glazing options

- Aluminium frame (standard profile NF or thermal break profile WF)
- Glazing type D, 16 mm

Sectional Door LPU 42

Double-skinned steel sections

S-panelled

Woodgrain

External views

(The illustrations correspond to size 2500 × 2125 mm. Deviations may occur with other door sizes.)

Basic model

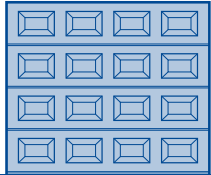

Style S0

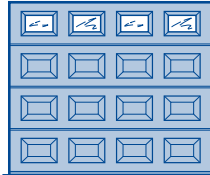

Style S1 with decorative rail (diamond)

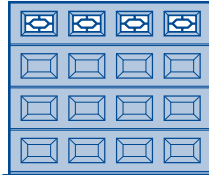

Style S2 with decorative rail (cross)

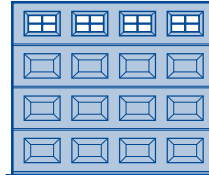

Style S10

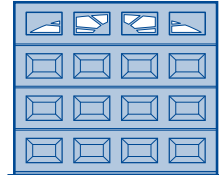

Size range

Door width in 1 mm increments, door height in grid height. Intermediate heights are possible up to LZ = 5500 mm in certain areas.

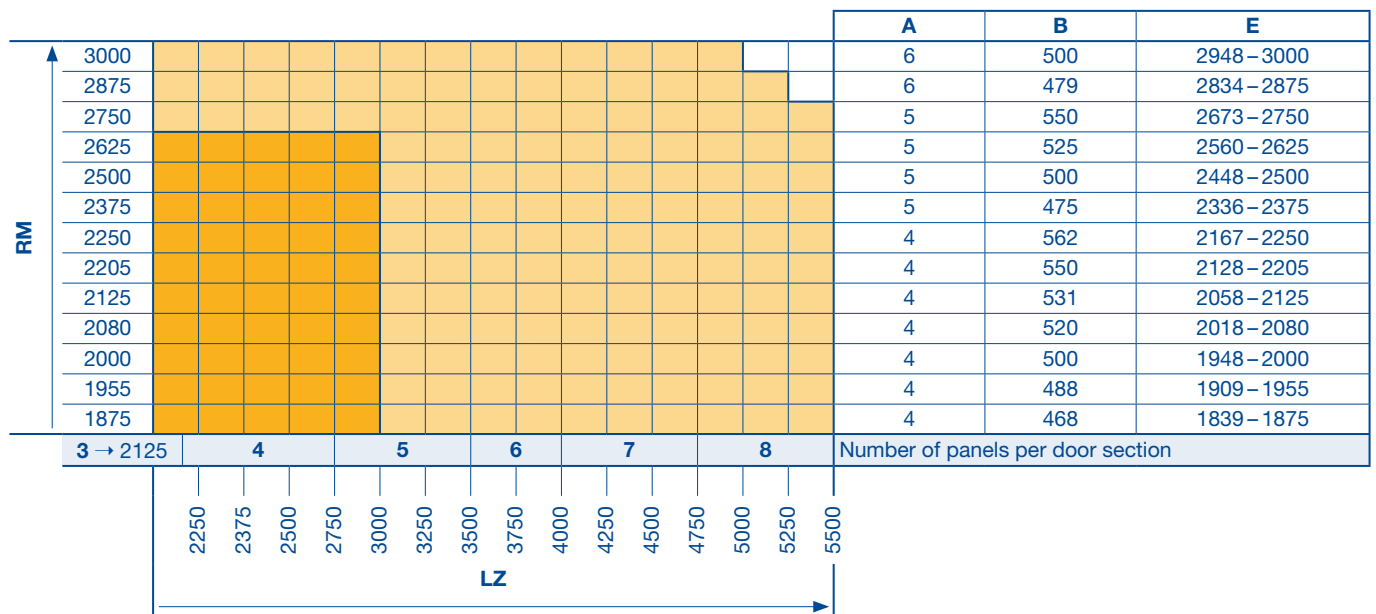

 Doors up to 3000 × 2625 mm with tension spring assembly

A No. of door sections

B Door section height

E This range can be shortened (intermediate heights, shortening only possible from top)

RM Grid height

LZ Clear frame dimensions (from 2000)

→ Up to width

Special equipment

Ventilation

- Ventilation slots in bottom seal, ventilation cross section 65 cm² for one metre door width

Glazing options – Panel glazing

Clear or crystal structure double panes, 16 mm

- Styles S0, S1, S2
- Styles S10, S20, S30, S40, S50, S60 (see page 17)

Sectional Door LPU 42

Double-skinned steel sections

S-panelled

Decograin

External views

(The illustrations correspond to size 2500 × 2125 mm. Deviations may occur with other door sizes.)

Basic model

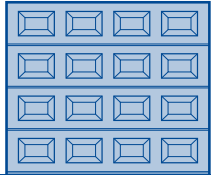

Style S0

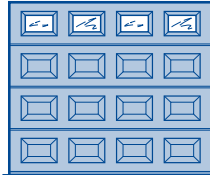

Style S1 with decorative rail (rhombus)

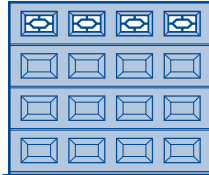

Style S2 with decorative rail (cross)

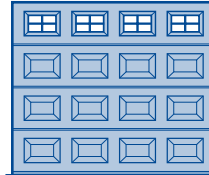

Style S10

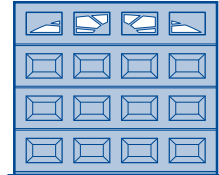

Size range

Door width in 1 mm increments, door height in grid height. Intermediate heights are possible up to LZ = 5500 mm in certain areas.

		A	B	E
RM	3000	6	500	2948 – 3000
	2875			
	2750			
	2625			
	2500	5	500	2448 – 2500
	2375	5	475	2336 – 2375
	2250	4	562	2167 – 2250
	2205			
	2125	4	531	2058 – 2125
	2080			
	2000	4	500	1948 – 2000
	1955			
	1875	4	468	1839 – 1875
3 → 2125		Number of panels per door section		
		2250 2375 2500 2750 3000 3250 3500 3750 4000 4250 4500 4750 5000 5250 5500		
		LZ		

 Doors up to 3000 × 2625 mm with tension spring assembly

A No. of door sections
B Door section height

E This range can be shortened (intermediate heights, shortening only possible from top) → Up to width

RM Grid height

LZ Clear frame dimensions (from 2000)

Special equipment

Ventilation

- Ventilation slots in bottom seal, ventilation cross section 65 cm² for one metre door width

Glazing options – Panel glazing

Clear or crystal structure double panes, 16 mm

- Styles S0, S1, S2
- Styles S10, S20, S30, S40, S50, S60 (see page 17)

Sectional Door LPU 67 Thermo

Double-skinned steel sections with thermal break/depth 67 mm

M-ribbed, L-ribbed

Silkgrain or Decograin

External views

(The illustrations correspond to size 2500 x 2125 mm. Deviations may occur with other door sizes.)

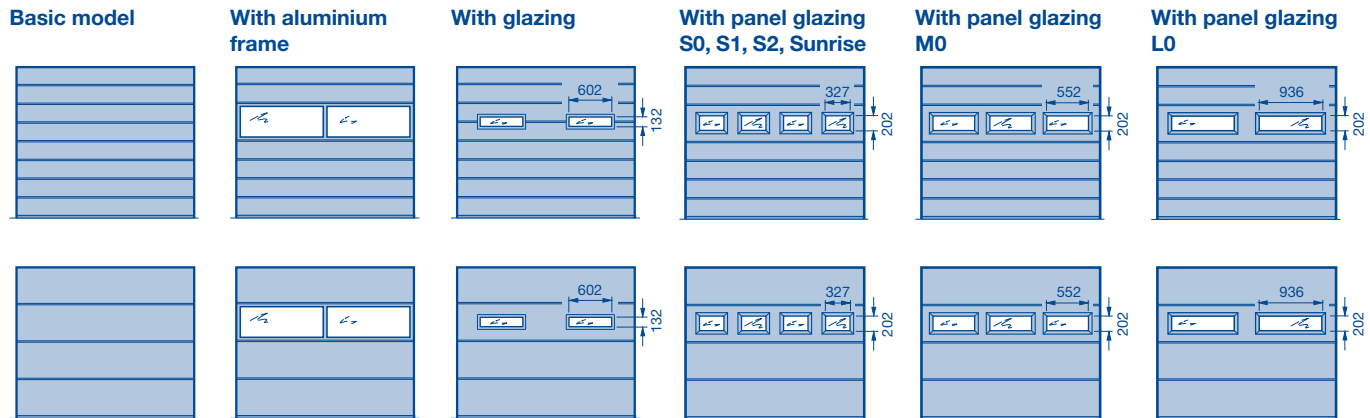

Size range

Door width in 5 mm increments up to LZ = 5000 mm, door height in grid height. Intermediate heights are possible.

												A	B			
RM	3000											●	●	●	6	500
	2875															
	2750													●	5	550
	2625															
	2500			■	■										5	500
	2375			■	■										5	475
	2250														4	562
	2205														4	550
	2125														4	531
	2080														4	520
	2000														4	500
	1955														4	488
1875														4	468	
		2		3			4			5		No. of glazings – aluminium frame and type D				
	3 → 2125	4		5			6		7		8		No. of glazings – type S			
	2 → 2240	3 → 2970			4 → 3690			5 → 4420			6		No. of glazings – type M			
		2 → 3400				3 → 4490				4		No. of glazings – type L				
		2250	2375	2500	2750	3000	3250	3500	3750	4000	4250	4500	4750	5000		
		LZ														

- Doors up to 3000 x 2500 mm with tension spring assembly (not possible with aluminium frames)
- A** No. of door sections
- B** Door section height
- RM** Grid height
- LZ** Clear frame dimensions (from 2000)
- Up to width
- Door size not possible for Silkgrain
- Door size for Silkgrain only possible with track application N or L

Sunrise Glazing

For sectional doors

LTE 42 / LPU 42

External views

Sunrise glazing for sectional doors LTE/LPU 42 for standard and special sizes

Glazing options for S-panelled type (not possible for doors with 3 panels for each section)

Style S10

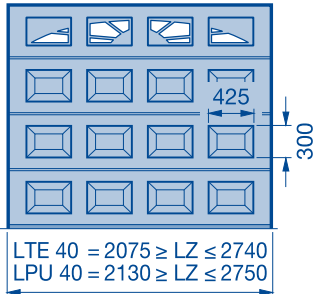

Style S20

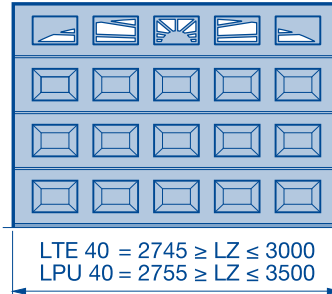

Style S30

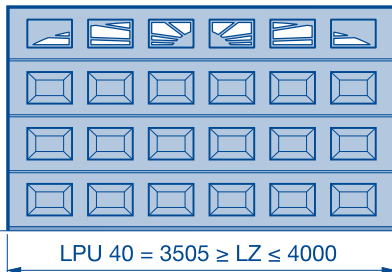

Style S40

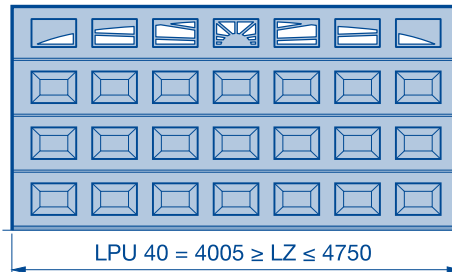

Style S50

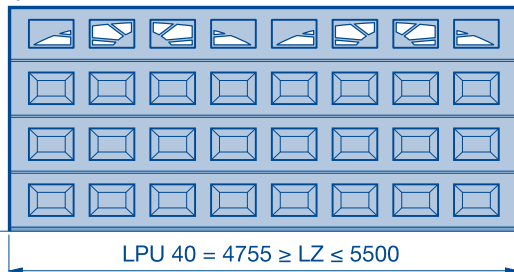

Style S60

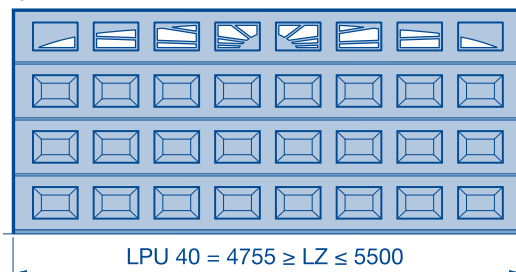

Design Element

For sectional doors¹⁾ and side doors

LPU 67 Decograin and Silkgrain

LPU 42 all surface finishes

Door view

Style arrangements (external views correspond to door size 2500 × 2125 mm). Style sideroom 200 mm up to LZ 3000 mm and 400 mm from LZ 3005 mm.



Style 450 with stainless steel plinth profile, with square perforation (2-part over 3000 mm width)



Style 451, stainless steel frame optional with stainless steel plinth profile as in style 450³⁾
Style 461, stainless steel frame and synthetic double pane²⁾ optional with stainless steel plinth profile as in style 450³⁾



Style 452, stainless steel frame with infill optional with stainless steel plinth profile as in style 450³⁾
Style 462, stainless steel frame with infill and synthetic double pane²⁾ optional with stainless steel plinth profile as in style 450³⁾



Style 454, large stainless steel square, optional with stainless steel plinth profile as in style 450



Style 456, small stainless steel squares, optional with stainless steel plinth profile as in style 450³⁾ 2 squares only in the bottom section with plinth profile

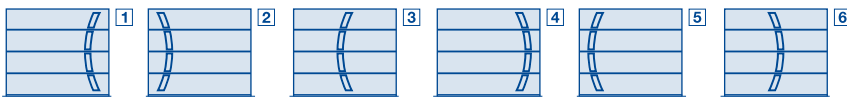

Style 457, curved stainless steel frame

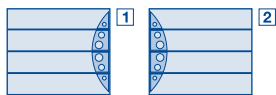

Style 458, stainless steel hole arc

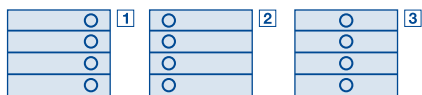

Style 459, with stainless steel ring
Style 469, with stainless steel ring and synthetic double pane²⁾.

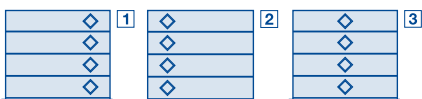

Style 471, stainless steel frame optional with stainless steel plinth profile as in style 450³⁾
Style 481, stainless steel frame and synthetic double pane²⁾ optional with stainless steel plinth profile as in style 450³⁾

Side door view

Style arrangements (external views correspond to door size 1000 × 2125 mm, other door sizes may have a different design)

Style 450

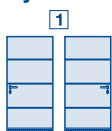

Style 451, 461²⁾

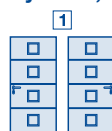

Style 452, 462²⁾

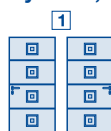

Style 454

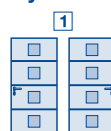

Style 456

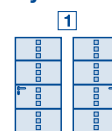

Style 457

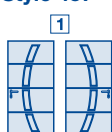

Style 458

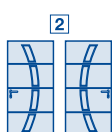

Style 459, 469²⁾

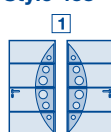

Style 471, 481

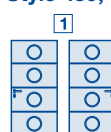

Style 471, 481

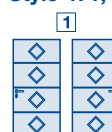

Styles 451, 452, 454, 456, 459, 461, 462, 469, 471 and 481 optional with stainless steel plinth profile as in style 450 (only on door in door heights RM 2125 and 2250 mm)

1) Except doors with wicket doors

2) LPU 42 glazing with synthetic double pane clear (DS) or crystal structure (DK), clear view 160 × 160 mm, pane thickness 41 mm; LPU 67 synthetic triple pane clear (S3) or crystal structure (U3), clear view 160 × 160 mm, pane thickness 66 mm

3) Only for RM height 2125 and 2250 mm

Design Element

For sectional doors

LPU 42, T-ribbed

Silkgrain

View of design inlay elements

Style arrangements (other arrangements on request)

View of sectional door
2500 × 2125

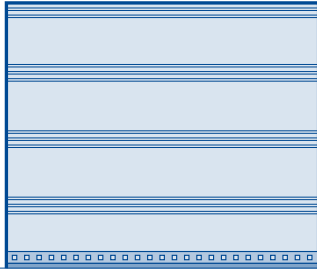

View of sectional door
5000 × 2125

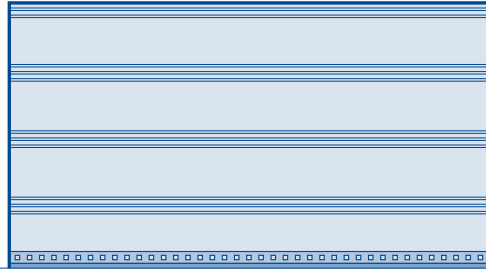

Side door view
1000 × 2125

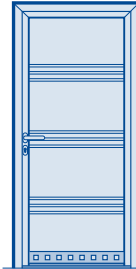

Style 450 with stainless steel plinth profile with / without square perforation
Ordering size width:
Up to 3000 mm 1-part
Over 3000 mm 2-part

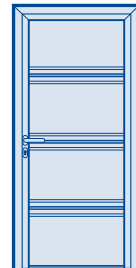

Style 501 with continuous inlays in stainless steel, timber look or RAL to choose



Style 500 with divided inlays (2 × 435 mm) in stainless steel or timber look

Sectional Door LPU 42 with Wicket Door with Trip-Free Threshold

S-Ribbed, M-Ribbed, L-Ribbed

Woodgrain, Sandgrain, Micrograin, Silkgrain or Decograin

External views

(The illustrations correspond to door height 2125 mm. Deviations may occur with other door heights. Due to the low threshold height, the ground in front of the garage must be level or sloped to guarantee smooth opening of the wicket door (opening outwards) - see page 48.)

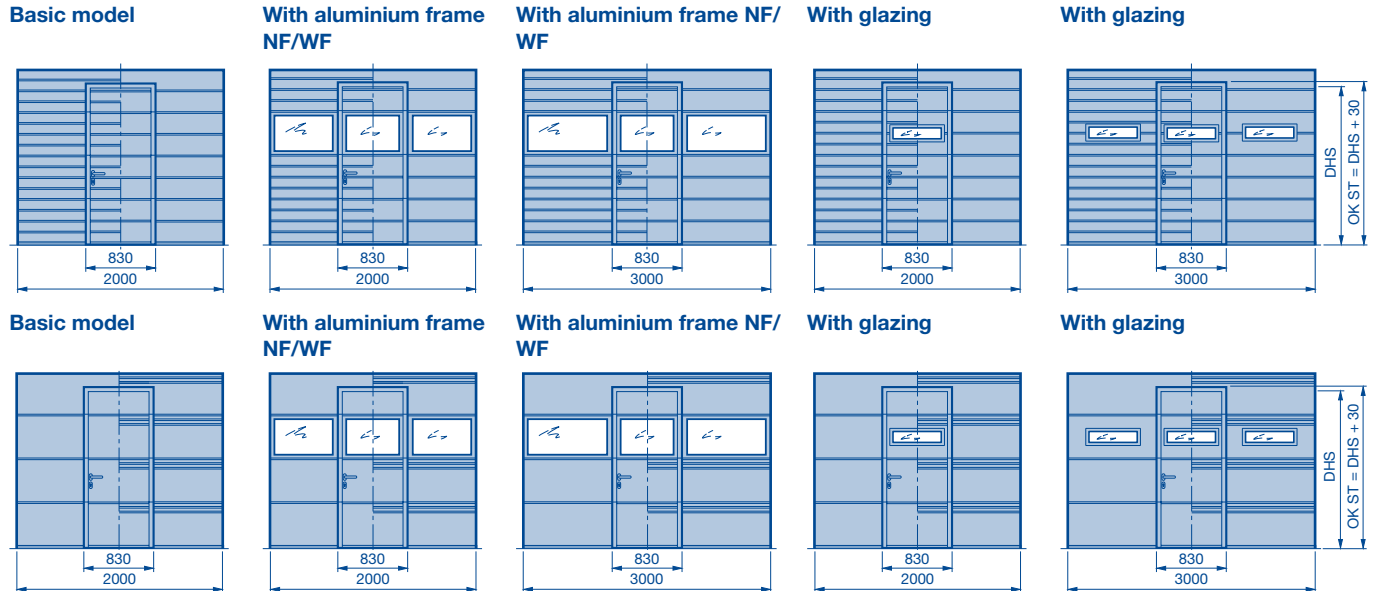

Wicket doors

The wicket doors are always in four parts and, in the S-ribbed version, only with even spacing of the ribs. The clear passage width of the wicket door is 830 mm and the threshold height starts at 5 mm and increases to 10 mm. Beyond their standard arrangements, wicket doors **without** glazing can be offset to a fixed edge distance of 500 mm. No design elements possible.

Size range

Door width in 5 mm increments. Door height in grid height. Intermediate heights possible from 5 door sections. See track applications for the ceiling height and clear passage (pages 38 - 39, 42). **Please observe the size ranges of the door types.**

					A	B	C	D	DrH
RM	3000				6	500	1955	1955	831
	2875	●	●	●	6	479	1871	1871	799
	2750				5	550	2155	2155	906
	2625	●	●	●	5	525	2055	2055	868
	2500				5	500	1955	1955	831
	2375				5	475	1855	1855	793
	2250				4	562	2123	2203	924
	2205				4	550	2075	2155	906
	2125				4	531	1999	2079	877
	2080				4	520	1955	2035	861
	2000				4	500	1875	1955	831
	1955				4	488	1827	1907	813
	1875				4	468	1747	1827	782
		3 → 2500	5 → 3500	7 → 4000	No. of ventilation grilles with 40 cm ² ventilation cross section each				
	3		4	No. of infills in aluminium frame per door section					
	1 → 2500	3 → 3500	4 → 4000	No. of type D, M glazings per door section					
	1 → 2370	3 → 3500	4 → 4000	No. of type S glazings per door section					
	2375	2500	2750	3000	3250	3500	3750	4000	
	LZ								

- A** No. of door sections
- B** Door section height
- C** Clear passage height of wicket door (DHS)
- D** Clear passage height of wicket door (DHS) with top glazing type D, S, M
- DrH** Lever height
- RM** Grid height
- LZ** Clear frame dimensions (from 2000)
- OK ST** Top edge of wicket door = DHS + 30 mm
- Up to width
- Only possible in intermediate heights for Sandgrain, Micrograin, Silkgrain and Decograin. Intermediate heights from 2875 (from RM 3000) and from 2575 (from RM 2750).

Notes:

- From LZ ≥ 3505 mm the wicket door is set off-centre!
- Sectional door with wicket door only possible with track application N or L!
- For doors up to RM 2250 and with top glazing type D, S, M, the distance from FFL to the bottom edge of the lintel must be equal to or greater than the ordering size (RM).
- For linkage assembly for multiple-point locking in doors with wicket door with 4 sections, a clearance of 500 mm is required outside above the door (see page 36).

Ventilation via S/M/L-ribbed panels

- Ventilation grille, ventilation cross section 40 cm² each arrangement



- Aluminium frame with expanded mesh, 58 % ventilation cross section

Glazing options

- Aluminium frame (standard profile NF or thermal break profile WF)
- Glazing type D, 16 mm
- Panel glazing type S or M, 22 mm
- With wicket door with multiple-point locking, glazings are only possible above the wicket door (from 5th section from the bottom)
- With integrated overhead door closer, glazing type S, M, NF & WF not possible in 4th wicket door section, only to right and left of the wicket door (except for wicket door arrangement "a" & "b", here only on request)
- Glazing in the 1st and 2nd section on request

Sectional Door LPU 42 with Wicket Door with Trip-Free Threshold

S-Ribbed, M-Ribbed, L-Ribbed

Woodgrain, Sandgrain, Micrograin, Silkgrain or Decograin

External views (matching for doors with glazing)

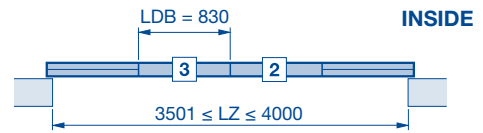
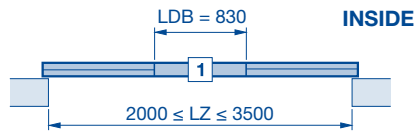

Glazing type D



Glazing type D

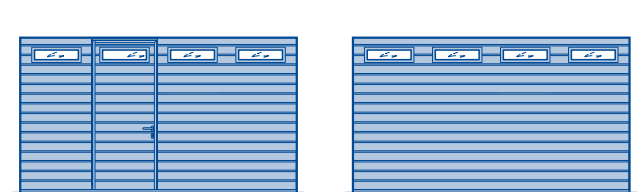

Glazing type S



Glazing type S



Glazing type M



Glazing type M



Aluminium frame NF/WF

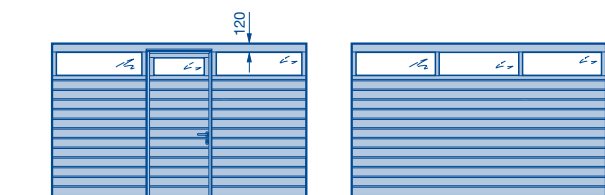

Aluminium frame NF/WF



The illustrations correspond to door height 2125 mm and arrangement 3.

Sectional Door LPU 42 with Wicket Door with Trip-Free Threshold

S-panelled

Woodgrain or Decograin

External views

(The illustrations correspond to size 2500 × 2125 mm. Deviations may occur with other door sizes. Due to the low threshold height, the ground in front of the garage must be level or sloped to guarantee smooth opening of the wicket door (opening outwards) - see page 48.

Basic model

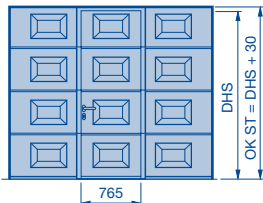

Style S0

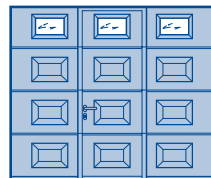

Style S1 with decorative rail (rhombus)

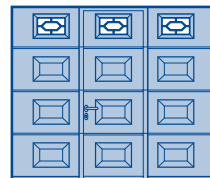

Style S2 with decorative rail (cross)

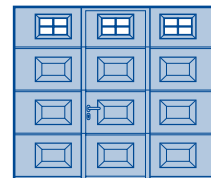

Wicket doors

The wicket doors are always in four parts. The clear passage width of the wicket door is 765 mm and the threshold height starts at 5 mm and increases to 10 mm.

Size range

Door width in 5 mm increments, door height only in grid height. Intermediate heights are not possible. See track applications for the ceiling height and clear passage (pages 38 - 39, 42).

		A	B	C	DrH			
RM	3000	6	500	1955	831			
	2875	6	479	1871	799			
	2750	5	550	2155	906			
	2625	5	525	2055	868			
	2500	5	500	1955	831			
	2375	5	475	1855	793			
	2250	4	562	2203	924			
	2205	4	550	2155	906			
	2125	4	531	2079	877			
	2080	4	520	2035	861			
	2000	4	500	1955	831			
1955	4	488	1907	813				
		Numbers of panels/panel glazings per door section						
		3	4	5				
LZ		2500	2750	3000	3250	3500	3750	4000

A	No. of door sections
B	Door section height
C	Clear passage height of wicket door (DHS)
DrH	Lever height
RM	Grid height
LZ	Clear frame dimensions (from 2000 mm)
OK ST	Top edge of wicket door = DHS + 30 mm
→	Up to width
●	Grid heights RM not possible with Decograin

Notes:

- With 4 panels, the wicket door is set off-centre!
- Sectional door with wicket door only possible with track application N or L!
- For doors up to 2250 mm, the distance from FFL to the bottom edge of the lintel must be equal to or greater than the ordering size (RM).
- For linkage assembly for multiple-point locking in doors with wicket door with 4 sections, a clearance of 500 mm is required outside above the door (see page 36).

Special equipment

Glazing options – panel glazing

Clear or crystal structure double panes, 16 mm

- Glazing S0
- Glazing S1
- Glazing S2
- Glazing S10, S20 (see page 17)
- With wicket door with multiple-point locking, glazings are only possible above the wicket door (from 5th section from the bottom)
- With integrated overhead door closer, glazing type S not possible in the 4th wicket door section (only left and right next to the wicket door)
- Glazing in the 1st and 2nd section on request

Sectional Door LPU 42 with Wicket Door with Trip-Free Threshold

Arrangement of the wicket door

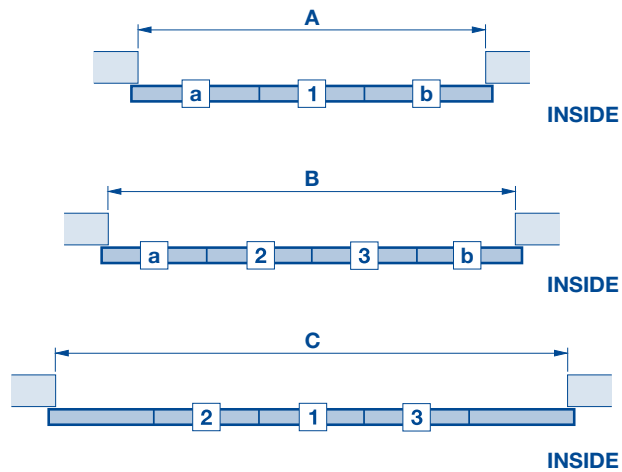

Note:

Arrangement "a" and "b" only for S-, M and L-ribbed versions (glazing possible on request). 500 mm fixed distance from the edge.

Note:

Wicket door only opening outwards.

	A	B	C
Sectional door S, M, L, D or T-ribbed	2000 – 3500	3501 – 4000	–
Sectional door, S-panelled	2000 – 2500	2501 – 3250	3251 – 4000

Sectional Door LPU 42 with Wicket Door and Threshold Rail

Double-skinned steel sections

S-ribbed, M-ribbed, L-ribbed, D-ribbed, T-ribbed

Woodgrain, Sandgrain, Micrograin, Silkgrain or Decograin

External views

(The illustrations correspond to door height 2125 mm. Deviations may occur with other door heights. The ground in front of the garage must be level or sloped to guarantee smooth opening of the wicket door (opening outwards) – see page 48.)

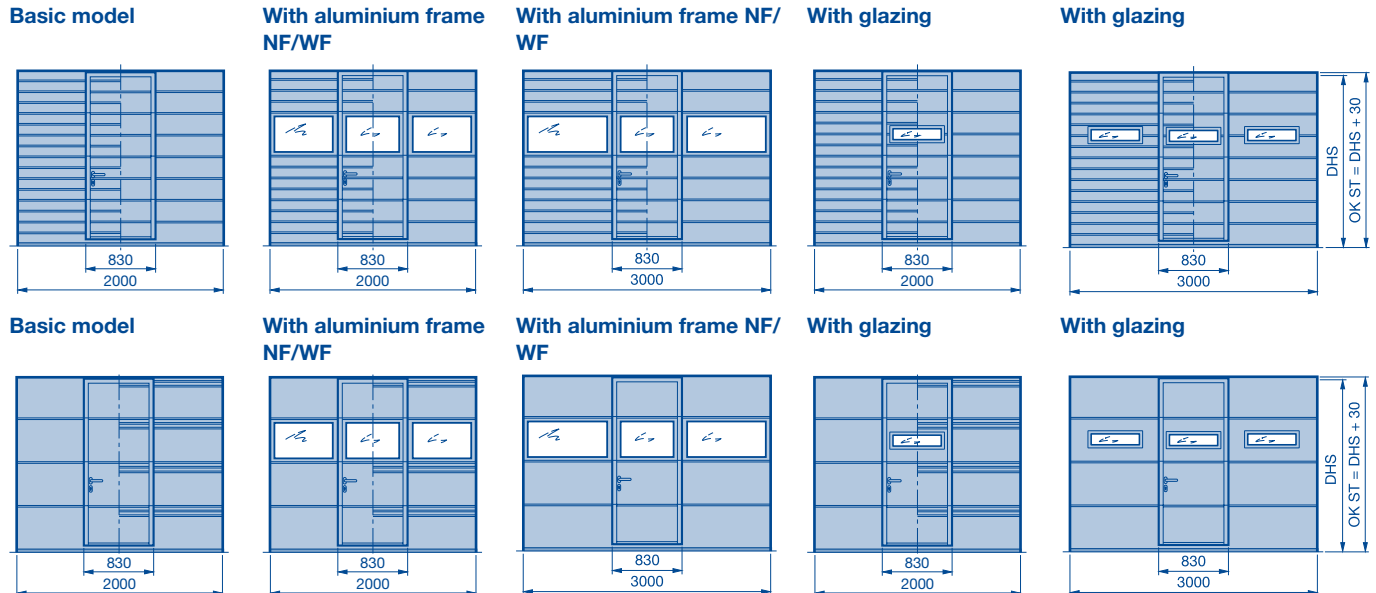

Wicket doors

The wicket doors are always in four parts and, in the S-ribbed version, only with even spacing of the ribs. The clear passage width of the wicket door is 830 mm, the threshold height is 60 mm (distance from top edge of wicket door to FFL is 38.5 mm). No design elements possible.

Size range

Door width in 1 mm increments. Door height in grid height. Intermediate heights from 5 door sections on request. See track applications for the ceiling height and clear passage (pages 38 - 39). **Please observe the size ranges of the door types.**

		A	B	C	D	DrH
RM	3000	6	500	1955	1955	831
	2875	6	479	1871	1871	799
	2750	5	550	2155	2155	906
	2625	5	525	2055	2055	868
	2500	5	500	1955	1955	831
	2375	5	475	1855	1855	793
	2250	4	562	2123	2203	924
	2205	4	550	2075	2155	906
	2125	4	531	1999	2079	877
	2080	4	520	1955	2035	861
	2000	4	500	1875	1955	831
	1955	4	488	1827	1907	813
	1875	4	468	1747	1827	782
	3 → 2500		5	No. of ventilation grilles with 40 cm ² ventilation cross section each		
3		No. of infills in aluminium frame per door section				
1 → 2500		3	No. of type D, M glazings per door section			
1 → 2370		3	No. of type S glazings per door section			
LZ		2375	2500	2750	3000	

- A** No. of door sections
- B** Door section height
- C** Clear passage height of wicket door (DHS)
- D** Clear passage height of wicket door (DHS) with top glazing type D, S, M
- DrH** Lever height
- RM** Grid height
- LZ** Clear frame dimensions (from 2000 mm)
- OK ST** Top edge of wicket door = DHS + 30 mm
- Up to width
- Only possible in intermediate heights for Sandgrain, Micrograin, Silkgrain and Decograin. Intermediate heights from 2875 (from RM 3000) and from 2575 (from RM 2750).

Notes:

- Sectional door with wicket door only possible with track application N or L!
- Wicket door multiple-point locking not possible.
- Only centre wicket door position possible.

Glazing options

- Aluminium frame (standard profile NF or thermal break profile WF)
- Glazing type D, 16 mm
- Panel glazing type S or M, 22 mm
- Glazing possible from the 3rd wicket door section and above the wicket door (from 3rd section from bottom)
- Glazing in the 1st and 2nd section on request

Arrangement of the wicket door

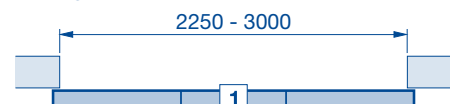

Sectional Door LPU 42 with Wicket Door and Threshold Rail

Double-skinned steel sections

S-panelled

Woodgrain or Decograin

External views

(The illustrations correspond to size 2500 × 2125 mm. Deviations may occur with other door sizes. The ground in front of the garage must be level or sloped to guarantee smooth opening of the wicket door (opening outwards) – see page 48.)

Basic model

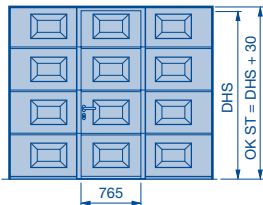

Style S0

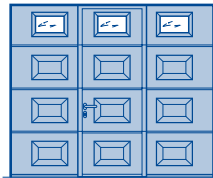

Style S1 with decorative rail (rhombus)

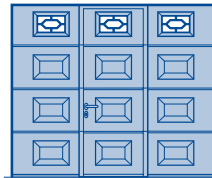

Style S2 with decorative rail (cross)

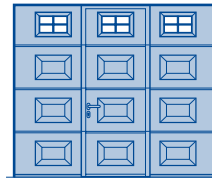

Wicket doors

The wicket doors are always in four parts. The clear passage width of the wicket door is 765 mm, the threshold height is 60 mm (distance from top edge of wicket door to FFL is 38.5 mm).

Size range

Door width in 5 mm increments, door height only in grid height. Intermediate heights are not possible. See track applications for the ceiling height and clear passage (pages 38-39). **Please observe the size ranges of the door types.**

RM			A	B	C	DrH
	3000			6	500	1955
2875	●	●	6	479	1871	799
2750	●	●	5	550	2155	906
2625	●	●	5	525	2055	868
2500			5	500	1955	831
2375			5	475	1855	793
2250			4	562	2203	924
2205	●	●	4	550	2155	906
2125			4	531	2079	877
2080	●	●	4	520	2035	861
2000			4	500	1955	831
1955	●	●	4	488	1907	813
	3	4	Numbers of panels/panel glazings per door section			

A	No. of door sections
B	Door section height
C	Clear passage height of wicket door (DHS)
DrH	Lever height
RM	Grid height
LZ	Clear frame dimensions (from 2250 mm)
OK ST	Top edge of wicket door = DHS + 30 mm
→	Up to width
●	Grid heights RM not possible with Decograin

Notes:

- Sectional door with wicket door only possible with track application N or L!
- Wicket door multiple-point locking not possible.
- Only centre wicket door position possible.

Special equipment

Glazing options – Panel glazing

Clear or crystal structure double panes, 16 mm

- Glazing S0
- Glazing S1
- Glazing S2
- Glazing S10, S20 (see page 17)
- Glazing possible from the 3rd wicket door section and above the wicket door (from 3rd section from bottom)
- Glazing in the 1st and 2nd section on request

Arrangement of the wicket door

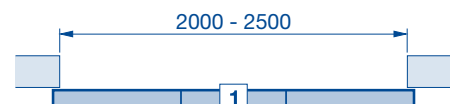

Sectional Door LTH 42

S-ribbed, M-ribbed, L-ribbed, V-panelled

Nordic Pine/Hemlock

External views

(The illustrations correspond to size 2500 × 2125 mm. Deviations may occur with other door sizes.)

Basic model S-ribbed



Basic model M-ribbed

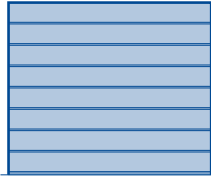

Basic model L-ribbed

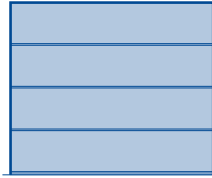

Basic model V-panelled

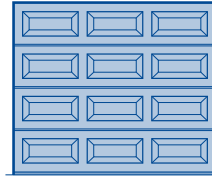

With glazing V0

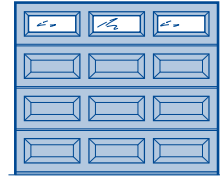

Size range

Door width in 10 mm increments. Intermediate heights are possible (on request for S-ribbed versions).

RM	S- / M- / L-ribbed					V-panelled
	A	B	C ₁	C ₂	C ₃	A
3000	6	500	125	250	-	6
2875	6	479	120	239	-	6
2750	5	550	138	275	-	6
2625	5	525	131	262	-	5
2500	5	500	125	250	-	5
2375	5	475	119	237	-	5
2250	4	562	141	281	-	5
2205	4	550	138	275	-	
2125	4	531	133	265	-	4
2080	4	520	130	260	-	
2000	4	500	125	250	-	4
1955	4	488	122	234	-	
1875	4	468	117	234	-	4

		Numbers of panels/panel glazings per door section			
		3	4	5	6
LZ	2250				
	2375				
	2500				
	2750				
	3000				
	3250				
	3500				
	3750				
	4000				
	4250				
	4500				
	4750				
5000					

Note:

Sectional door LTH 42 only with torsion spring assembly

- A** No. of door sections
B Door section height
C₁ S-ribbed spacing

- C₂** M-ribbed spacing
C₃ L-ribbed spacing
RM Grid height

- LZ** Clear frame dimensions (from 2000 mm)

Ventilation

- Ventilation slots in bottom seal (standard), ventilation cross section 65 cm² for one metre door width

Glazing options (for panelled versions only)

- Panel glazing with clear or crystal structure, 3 mm

Sectional door LTH 42 with special designs

Nordic Pine/Hemlock

External views

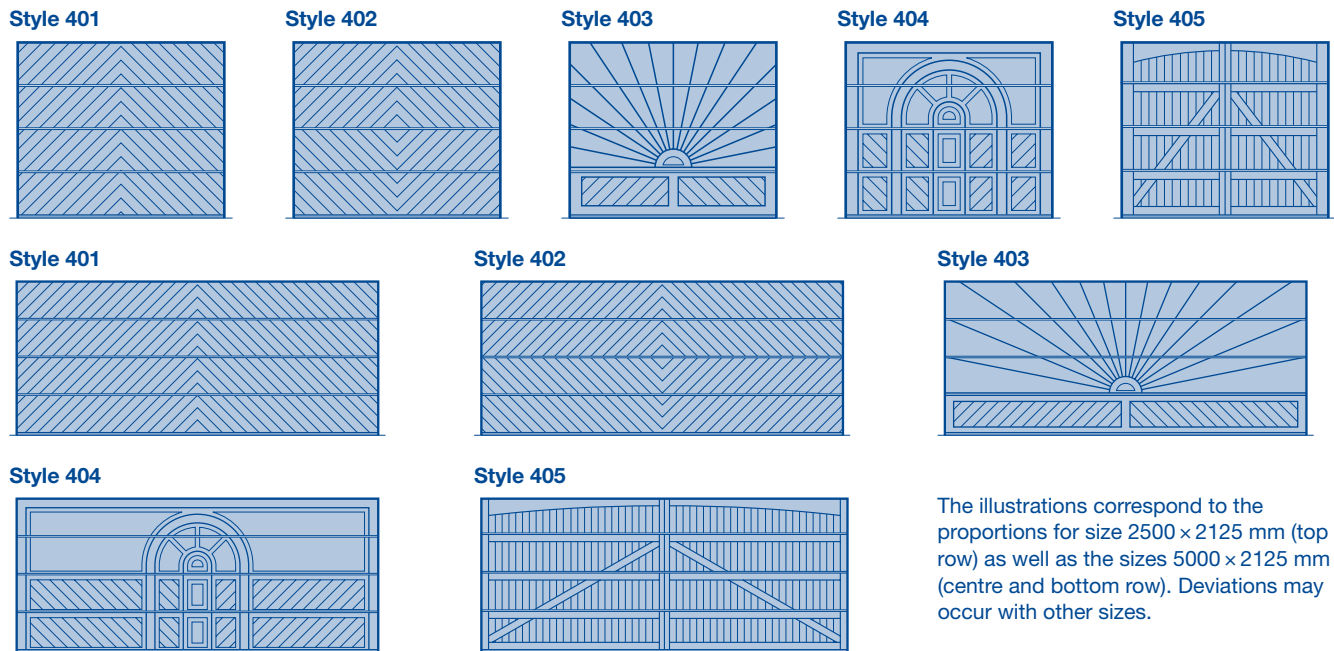

The illustrations correspond to the proportions for size 2500 × 2125 mm (top row) as well as the sizes 5000 × 2125 mm (centre and bottom row). Deviations may occur with other sizes.

Size range

Door width in 10 mm increments. Intermediate heights are possible. Further designs on request.

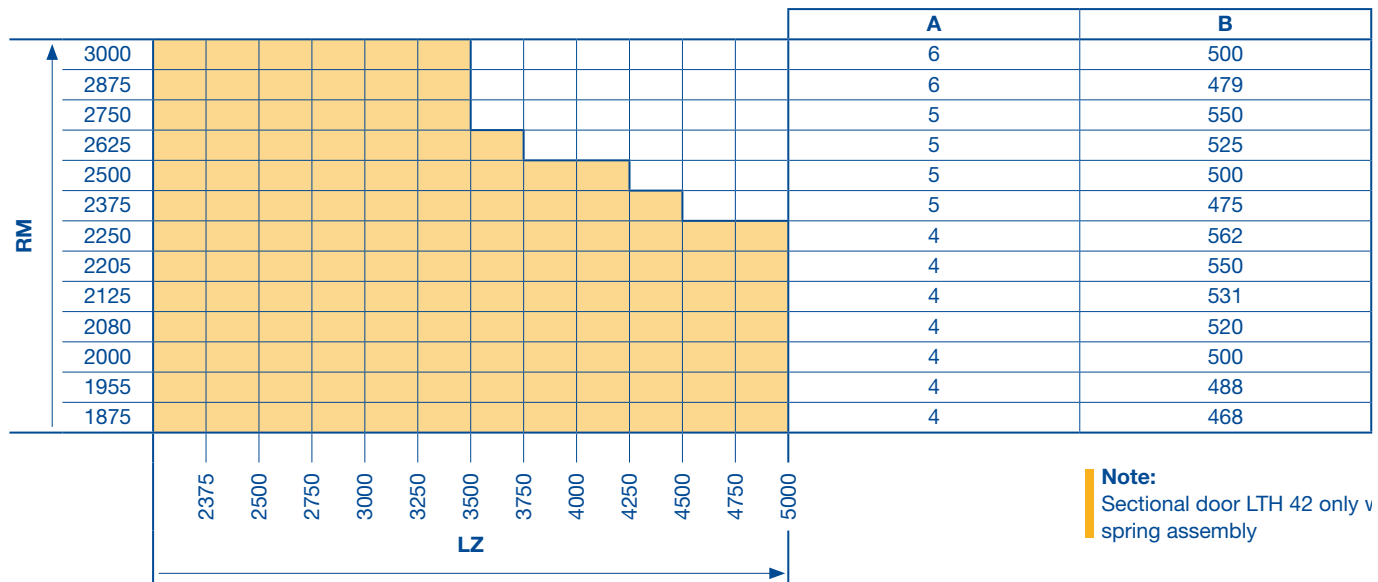

Note:
Sectional door LTH 42 only v
spring assembly

- A** No. of door sections
- B** Door section height
- RM** Grid height
- LZ** Clear frame dimensions (from 2250 mm)

Ventilation

- Ventilation slots in bottom seal (standard), ventilation cross section 65 cm² for one metre door width

Sectional Door LPU 42

Double-skinned steel sections, fitting in front of the reveal

S-ribbed

Woodgrain

External views

(The illustrations correspond to size 2500 × 2125 mm. Deviations may occur with other door sizes.)

Basic model

With aluminium frame
NF/WF

With glazing



Size range

Door width in 1 mm increments, door height in grid height. Intermediate heights are possible.

														A	B	C	
RM	2205													4	550	138	
	2125													4	531	133	
	2080													4	520	130	
	2000													4	500	125	
	1955													4	488	122	
	1875													4	468	117	
		4		6								No. of ventilation grilles with 40 cm ² ventilation cross section each					
		2		3								Number of infills per door section with glazing					
		2250	2375	2500	2750	3000	3250	3500	3750	4000	4250	4500	4750	5000			
		LZ															

Doors up to 3000 × 2500 mm with tension spring assembly

A No. of door sections

B Door section height

C Spacing

RM Grid height

LZ Clear frame dimensions (from 2000 mm)

Special equipment

Ventilation

- Ventilation slots in bottom seal, ventilation cross section 65 cm² for one metre door width
- Ventilation grille, ventilation cross section 40 cm² each
- Aluminium frame with expanded mesh, 58 % ventilation cross section

Glazing options

- Aluminium frame (standard profile NF or thermal break profile WF)
- Glazing type D, 16 mm

Sectional Door LPU 42

Double-skinned steel sections, fitting in front of the reveal

M-ribbed

Woodgrain or Silkgrain

External views

(The illustrations correspond to size 2500 × 2125 mm. Deviations may occur with other door sizes.)

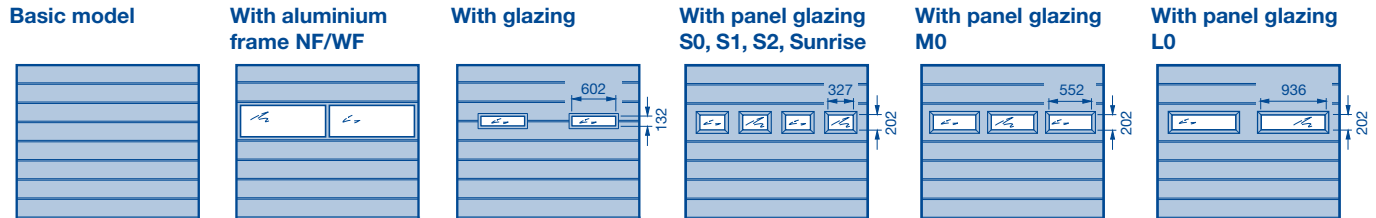

Size range

Door width in 1 mm increments, door height in grid height. Intermediate heights are possible.

												A	B	C			
RM	2205											4	550	275			
	2125											4	531	265			
	2080											4	520	260			
	2000											4	500	250			
	1955											4	488	244			
	1875											4	468	234			
		4	6											No. of ventilation grilles with 40 cm ² ventilation cross section each			
		2	3											No. of glazings – aluminium frame and type D			
3 → 2125		4	5											No. of glazings – type S			
2 → 2240		3												No. of glazings – type M			
		2												No. of glazings – type L			
		2250	2375	2500	2750	3000	3250	3500	3750	4000	4250	4500	4750	5000	LZ		

A No. of door sections
B Door section height
C Spacing
RM Grid height

LZ Clear frame dimensions (from 2000 mm)
 → Up to width

Special equipment

Ventilation

- Ventilation slots in bottom seal, ventilation cross section 65 cm² for one metre door width
- Ventilation grille, ventilation cross section 40 cm² each
- Aluminium frame with expanded mesh, 58 % ventilation cross section

Glazing options

- Aluminium frame (standard profile NF or thermal break profile WF)
- Glazing type D, 16 mm
- Panel glazing type S, M, L, 22 mm

Sectional Door LPU 42

Double-skinned steel sections, fitting in front of the reveal

L-ribbed

Woodgrain or Silkgrain

External views

(The illustrations correspond to size 2500 × 2125 mm. Deviations may occur with other door sizes.)

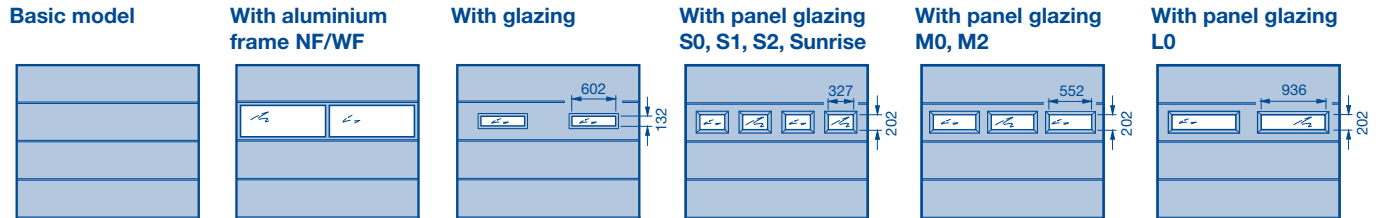

Size range

Door width in 1 mm increments, door height in grid height. Intermediate heights are possible.

														A	B	
RM	2205													4	550	
	2125													4	531	
	2080													4	520	
	2000													4	500	
	1955													4	488	
	1875													4	468	
		4	6											No. of ventilation grilles with 40 cm ² ventilation cross section each		
		2	3											No. of glazings – aluminium frame and type D		
3 → 2125		4	5											No. of glazings – type S		
2 → 2240		3												No. of glazings – type M		
		2												No. of glazings – type L		
		2250	2375	2500	2750	3000	3250	3500	3750	4000	4250	4500	4750	5000	LZ	

A No. of door sections
B Door section height
RM Grid height

LZ Clear frame dimensions (from 2000 mm)
→ Up to width

Special equipment

Ventilation

- Ventilation slots in bottom seal, ventilation cross section 65 cm² per metre of door width
- Ventilation grille, ventilation cross section 40 cm² each
- Aluminium frame with expanded mesh, 58 % ventilation cross section

Glazing options

- Aluminium frame (standard profile NF or thermal break profile WF)
- Glazing type D, 16 mm
- Panel glazing type S, M or L, 22 mm

Sectional Door LPU 42

Double-skinned steel sections, fitting in front of the reveal

S-panelled

Woodgrain

External views

(The illustrations correspond to size 2500 × 2125 mm. Deviations may occur with other door sizes.)

Basic model

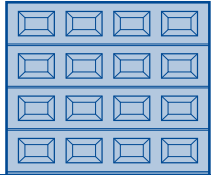

Style S0

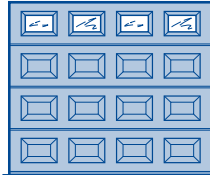

Style S1 with decorative rail (rhombus)

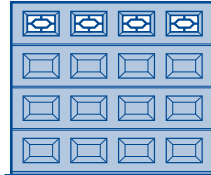

Style S2 with decorative rail (cross)

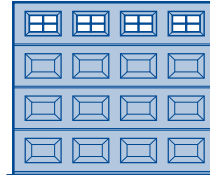

Style S10

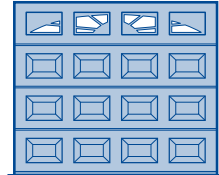

Size range

Door width in 1 mm increments, door height in grid height. Intermediate heights are possible.

														A	B	E			
RM	2205													4	550	2128 – 2205			
	2125													4	531	2058 – 2125			
	2080													4	520	2018 – 2080			
	2000													4	500	1948 – 2000			
	1955													4	488	1909 – 1955			
	1875													4	468	1839 – 1875			
		3 → 2125	4	5													Number of panels per door section		
		LZ 2250 2375 2500 2750 3000 3250 3500 3750 4000 4250 4500 4750 5000																	

A No. of door sections

B Door section height

E This range can be shortened (intermediate heights, shortening only possible from top)

RM Grid height

LZ Clear frame dimensions (from 2000 mm)

→ Up to width

Special equipment

Ventilation

- Ventilation slots in bottom seal, ventilation cross section 65 cm² for one metre door width

Glazing options – Panel glazing

Clear or crystal structure double panes, 16 mm

- Styles S0, S1, S2
- Designs S10, S20 (see page 17)

Track Application: Z

Z: Tension spring track application

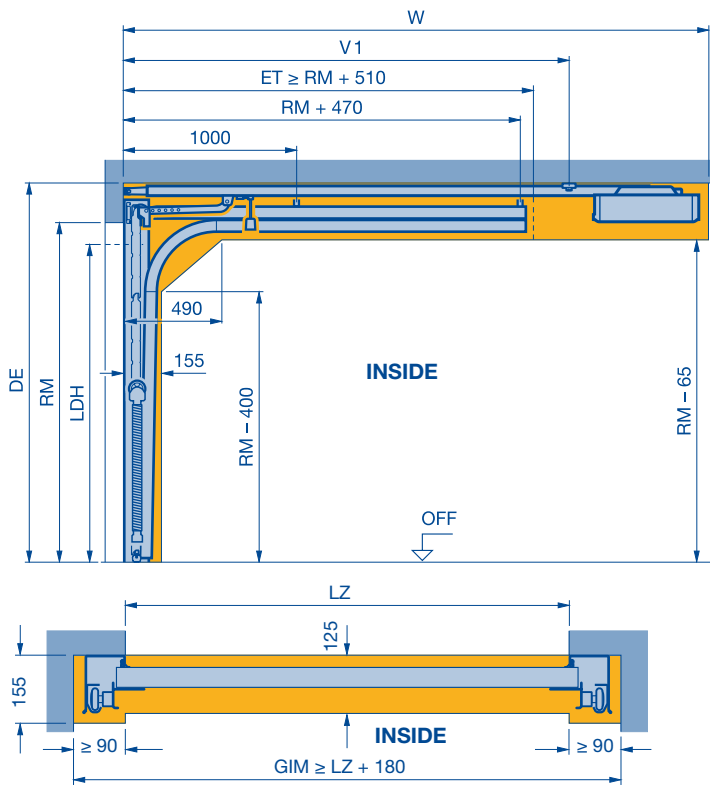

RM Height	Manual operation		With operator			
	Min. DE	LDH	Min. DE	Min. DE with Thermo Frame set 1	LDH	LDH (LPU 67 Thermo)
	RM + 100	RM - 80	RM + 115	RM + 145	RM - 30	RM - 55
1875	1975	1795	1990	2020	1845	1820
1955	2055	1875	2070	2100	1925	1900
2000	2100	1920	2115	2145	1970	1945
2080	2180	2000	2195	2225	2050	2025
2125	2225	2045	2240	2270	2095	2070
2205	2305	2125	2320	2350	2175	2150
2250	2350	2170	2365	2395	2220	2195
2375	2475	2295	2490	2520	2345	2320
2500	2600	2420	2615	2645	2470	2445
2625	2725	2545	2740	2765	2595	-

LDH Clear passage height

RM Grid height

LZ Clear frame dimensions

DE Ceiling height

Max. DE standard suspension = RM + 400

Max. DE with track suspension set = RM + 740

ET Distance back

GIM Inside garage dimension

V₁ Rear operator boom suspension

W Total distance back including operator head

Notes:

- The clearance for fitting and subsequent operation of the door must be complied with.
- No additional headroom is required for Thermo Frame set 4-5.
- LPU 67 Thermo not possible with ProMatic operator.
- LPU 67 Thermo not possible with aluminium frames.

ProMatic, SupraMatic E, P and HT	V ₁	W
With short boom (K) up to door height 2125	2775	3200
With medium boom (M) up to door height 2375	3025	3450
With long boom (L) up to door height 3000	3700	4125
With special length boom on request		

Track application: N

N: Normal track application

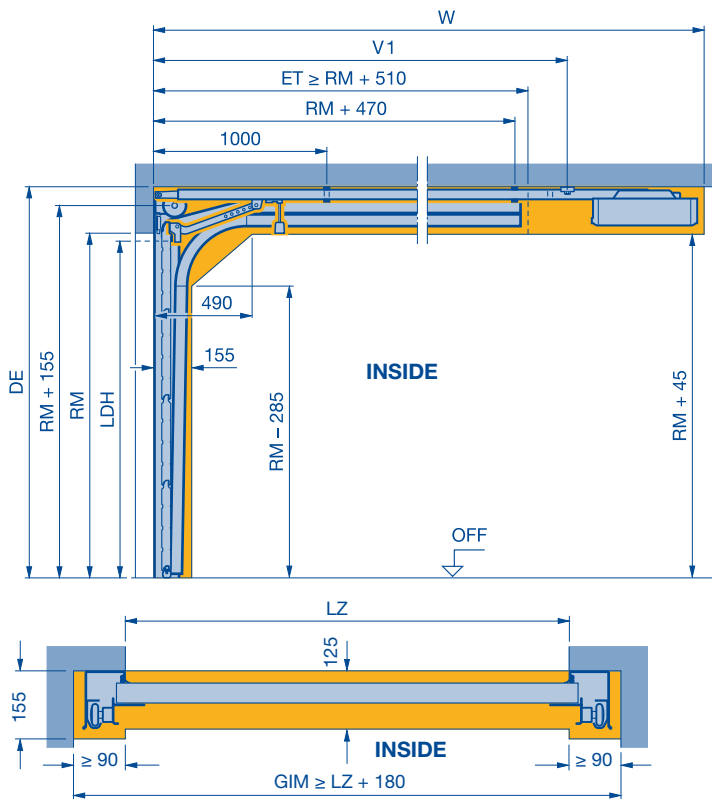

RM Height	Manual operation		With operator		
	Min. DE	LDH	Min. DE *	Min. DE with Thermo Frame set 1-2, 6, 7, 8, 9	LDH
	RM + 210	RM - 50	RM + 210	RM + 255	RM
1875	2085	1825	2085	2130	1875
1955	2165	1905	2165	2210	1955
2000	2210	1950	2210	2255	2000
2080	2290	2030	2290	2335	2080
2125	2335	2075	2335	2380	2125
2205	2415	2155	2415	2460	2205
2250	2460	2200	2460	2505	2250
2375	2585	2325	2585	2630	2375
2500	2710	2450	2710	2755	2500
2625	2835	2575	2835	2880	2625
2750	2960	2700	2960	3005	2750
2875	3085	2825	3085	3130	2875
3000	3210	2950	3210	3255	3000

LDH Clear passage height

RM Grid height

LZ Clear frame dimensions

DE Ceiling height

Max. DE standard suspension = RM + 515

Max. DE with track suspension set = RM + 850

ET Distance back

GIM Inside garage dimension

V₁ Rear operator boom suspension

W Total distance back including operator head

Notes:

- The clearance for fitting and subsequent operation of the door must be complied with.
- No additional headroom is required for Thermo Frame set 4-5.
- LPU 67 Thermo not possible with ProMatic operator.

Note:

* For doors under thermal loads, the operator is to be fitted 40 mm higher if applicable (RM + 210 + 40).

ProMatic, SupraMatic E, P and HT	LPU 42	LPU 67	V ₁	W
With short boom (K) up to door height 2250	2250	2125	2775	3200
With medium boom (M) up to door height 2500	2500	2375	3025	3450
With long boom (L) up to door height 3000	3000	3000	3700	4125
With special length boom on request				

Track application: L

L: Low headroom track application

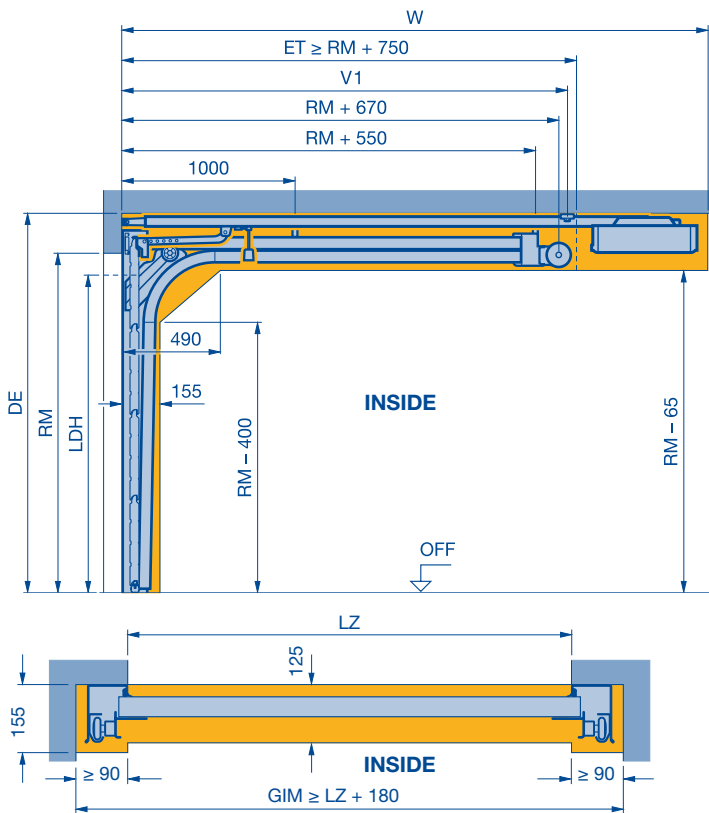

RM Height	Manual operation		With operator			
	Min. DE	LDH	Min. DE*	Min. DE with Thermo Frame set 1-2, 6, 7, 8, 9	LPU 42	
					LDH Up to LZ = 3000 mm	LDH From LZ = 3010 mm
RM + 100	RM - 100	RM + 115	RM + 145	RM - 30	RM - 80	
1875	1975	1775	1990	2020	1845	1795
1955	2055	1855	2070	2100	1925	1875
2000	2100	1900	2115	2145	1970	1920
2080	2180	1980	2195	2225	2050	2000
2125	2225	2025	2240	2270	2095	2045
2205	2305	2105	2320	2350	2175	2125
2250	2350	2150	2365	2395	2220	2170
2375	2475	2275	2490	2520	2345	2295
2500	2600	2400	2615	2645	2470	2420
2625	2725	2525	2740	2790	2595	2545
2750	2850	2650	2865	2895	2720	2670
2875	2975	2775	2990	3020	2845	2795
3000	3100	2900	3115	3145	2970	2920

RM Height	LPU 67 Thermo with operator	
	LDH Up to LZ = 3000 mm	LDH From LZ = 3010 mm
	RM - 55	RM - 105
1875	1820	1770
1955	1900	1850
2000	1945	1895
2080	2025	1975
2125	2070	2020
2205	2150	2100
2250	2195	2145
2375	2320	2270
2500	2445	2395
2625	-	-
2750	2695	2645
2875	-	-
3000	2945	2895

- LDH** Clear passage height
RM Grid height
LZ Clear frame dimensions
DE Ceiling height
 Max. DE with track suspension set = $RM + 740$
ET Distance back
GIM Inside garage dimension
V₁ Rear operator boom suspension
W Total distance back including operator head

Notes:

- The clearance for fitting and subsequent operation of the door must be complied with.
- For $DE > RM + 285$ an additional 120×60 extrusion is required to strengthen the suspension construction in the area of the torsion springs.
- No additional headroom is required for Thermo Frame set 4 - 5.
- LPU 67 Thermo not possible with ProMatic operator.

Note:

- * For doors under thermal loads, the operator is to be fitted 40 mm higher if applicable ($RM + 115 + 40$).

ProMatic, SupraMatic E, P and HT	V ₁	W
With short boom (K) up to door height 2125	2775	3200
With medium boom (M) up to door height 2375	3025	3450
With long boom (L) up to door height 3000	3700	4125
With special length boom on request		

Track Applications: H

H: High-lift track application

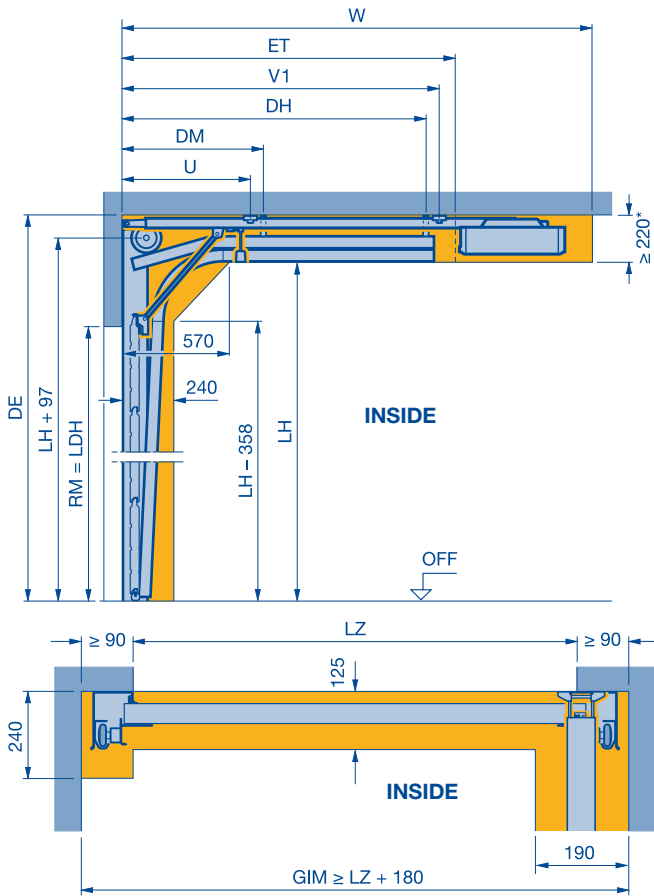

Not for versions with wicket door.

Door height RM Height	Track height			
	(1) with spring buffer		(2) with buffer stop	
	Min.	Max.	Min.	Max.
1875	2260	2634	2635	3190
1955	2340	2714	2715	3270
2000	2385	2759	2760	3315
2080	2465	2839	2840	3395
2125	2510	2884	2885	3440
2205	2590	2964	2965	3520
2250	2635	3009	3010	3565
2375	2760	3134	3135	3690
2500	2885	3259	3260	3815
2625	3010	3384	3385	3940
2750	3135	3509	3510	4065
2875	3315	3634	3635	4190
3000	3565	3759	3760	4315

- LDH** Clear passage height
- RM** Grid height
- LH** Structural opening
- LH** Track height
- LZ** Clear frame dimensions
- DE** Ceiling height
- DH** Rear ceiling anchor = $ET - 200$
- DM** Centre ceiling anchor = $DH / 2$
- ET** Distance back
(1) = $2 \times RM + 690 - LH$
(2) = $2 \times RM + 490 - LH$
- GIM** Minimum inside garage dimension
- U** Front operator boom suspension
- V₁** Rear operator boom suspension
- W** Total distance back including operator head
* With ThermoFrame ≥ 255

Notes:

- The clearance for fitting and subsequent operation of the door must be complied with.
- Not possible as LPU 67 Thermo.

ProMatic, SupraMatic E, P and HT	U	V ₁	W	Length of operator boom
With short boom (K) up to door height 2125	1100	2775	3200	3000
With medium boom (M) up to door height 2375	1100	3025	3450	3250
With long boom (L) up to door height 3000	1300	3700	4125	3925
With special length boom on request				

Track application H size range for LPU 42 with Woodgrain, Sandgrain, Micrograin and Decograin surface

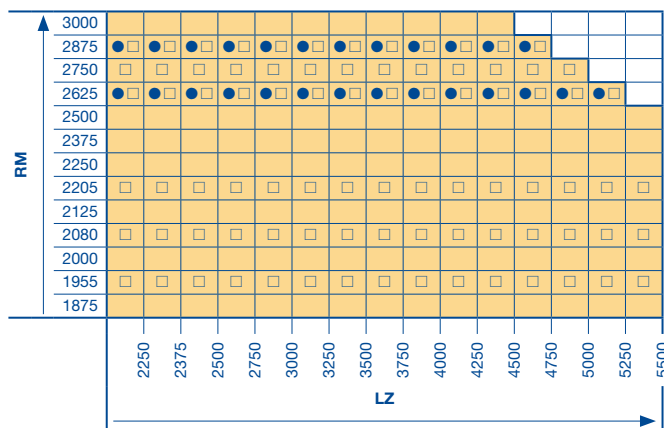

- Grid heights RM not possible with Decograin, Sandgrain, Silkgrain and Micrograin
- Grid heights RM not possible with Decograin (S-panelled)

Size range for LPU 42 with Silkgrain surface

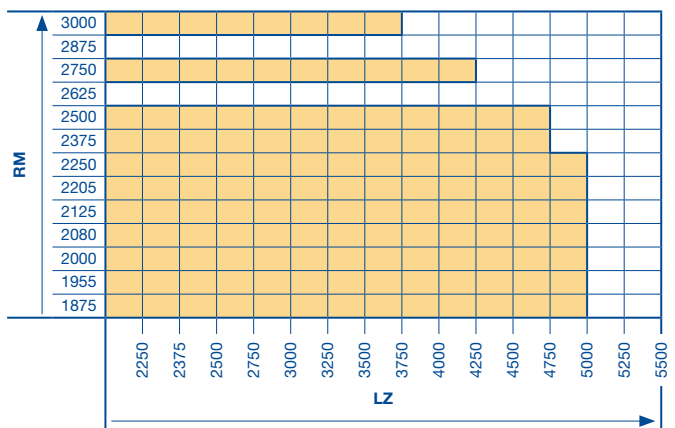

Track Application: N

(LPU 42) wicket door with trip-free threshold

N: Normal track application

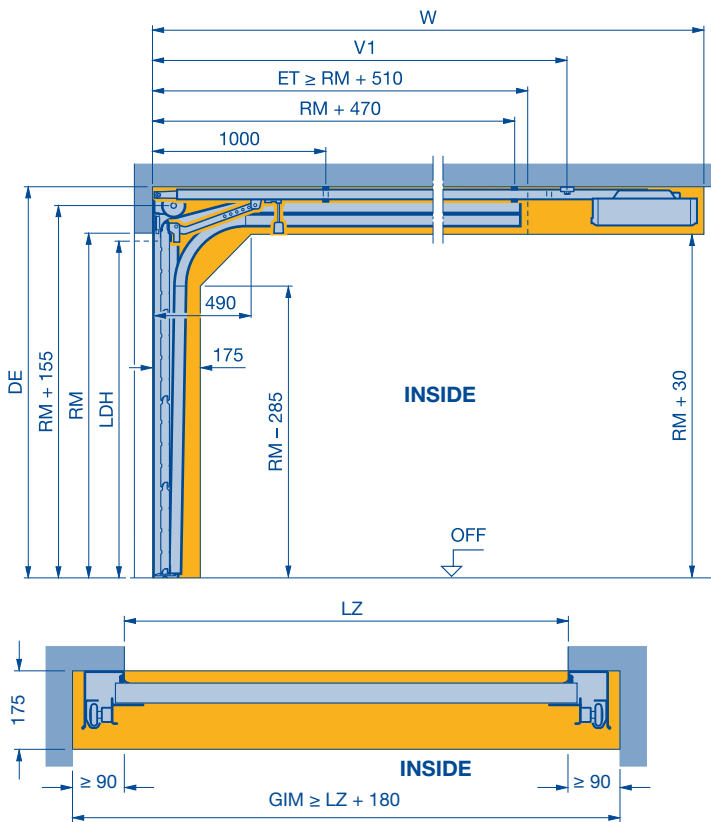

RM Height	Manual operation		With operator		
	Min. DE	LDH	Min. DE *	Min. DE with Thermo Frame set 1-2	LDH
	RM + 220	RM - 160	RM + 235	RM + 255	RM - 100
1875	2095	1715	2110	2130	1775
1955	2175	1795	2190	2210	1855
2000	2220	1840	2235	2255	1900
2080	2300	1920	2315	2335	1980
2125	2345	1965	2360	2380	2025
2205	2425	2045	2440	2460	2105
2250	2470	2090	2485	2505	2150
2375	2595	2215	2610	2630	2275
2500	2720	2340	2735	2755	2400
2625	2845	2465	2860	2880	2525
2750	2970	2590	2985	3005	2650
2875	3095	2715	3110	3130	2775
3000	3220	2840	3235	3255	2900

LDH Clear passage height

RM Grid height

LZ Clear frame dimensions

DE Ceiling height

Max. DE standard suspension = RM + 515

Max. DE with track suspension set = RM + 740

ET Distance back

GIM Inside garage dimension

V₁ Rear operator boom suspension

W Total distance back including operator head

Notes:

- The clearance for fitting and subsequent operation of the door must be complied with.
- Due to the low threshold height, the ground in front of the garage must be level or sloped to guarantee smooth opening of the wicket door (opening outwards) - see page 48.
- For doors up to 2250 mm in S-panelled versions or in S, M or L-ribbed versions and with top glazing type D, S and M, the distance from FFL to the bottom edge of the lintel must be equal to or greater than the ordering size (RM). Deviating sizes on request!
- Not possible as LPU 67 Thermo.

Note:

* For doors under thermal loads, the operator is to be fitted 40 mm higher if applicable (RM + 235 + 40).

ProMatic, SupraMatic E, P and HT	V ₁	W
With short boom (K) up to door height 2250	2775	3200
With medium boom (M) up to door height 2500	3025	3450
With long boom (L) up to door height 3000	3700	4125
With special length boom on request		

Clearance required for fitting the multiple-point locking linking rods

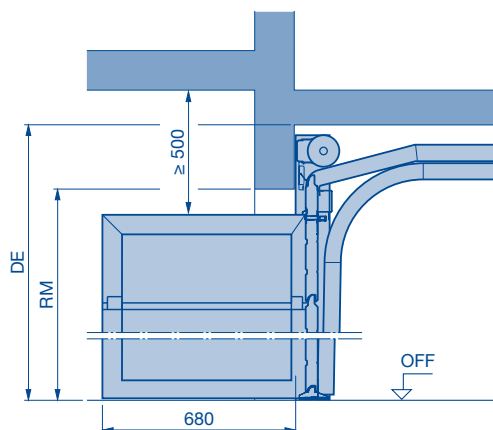

Track Application: L

(LPU 42) wicket door with trip-free threshold

L: Low headroom track application

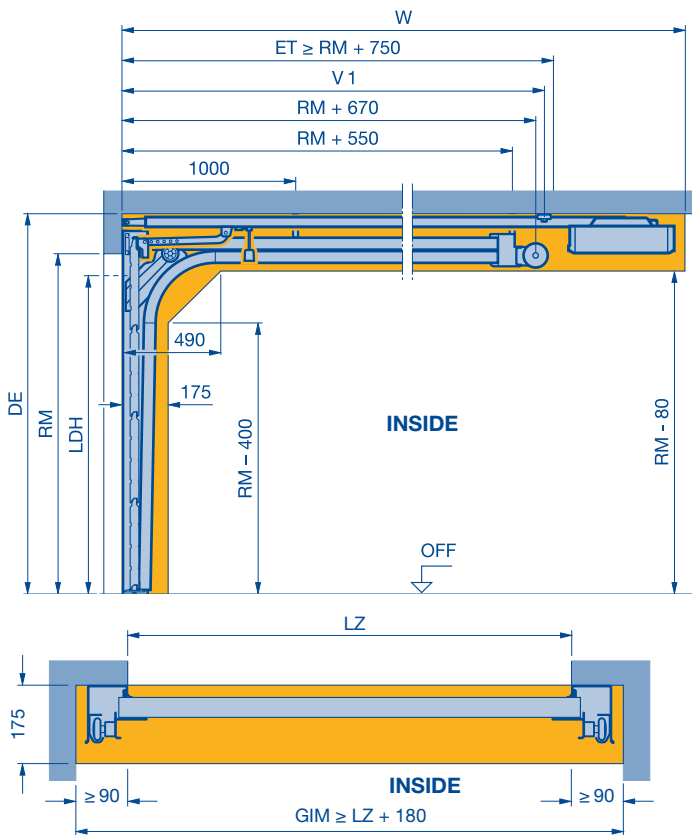

RM Height	Manual operation		With operator		
	Min. DE	LDH	Min. DE*	Min. DE with Thermo Frame set 1-2	LDH
	RM + 125	RM - 160	RM + 125	RM + 145	RM - 160
1875*	2000	1715	2000	2020	1715
1955	2080	1795	2080	2100	1795
2000	2125	1840	2125	2145	1840
2080	2205	1920	2205	2225	1920
2125	2250	1965	2250	2270	1965
2205	2330	2045	2330	2350	2045
2250	2375	2090	2375	2395	2090
2375	2500	2215	2500	2520	2215
2500	2625	2340	2625	2645	2340
2625	2750	2465	2750	2770	2465
2750	2875	2590	2875	2895	2590
2875	3000	2715	3000	3020	2715
3000	3125	2840	3125	3145	2840

* These versions are only available for S/M/L-ribbed doors

LDH Clear passage height

RM Grid height

LZ Clear frame dimensions

DE Ceiling height

Max. DE standard suspension = RM + 400

Max. DE with track suspension set = RM + 740 mm

ET Distance back

GIM Inside garage dimension

V₁ Rear operator boom suspension

W Total distance back including operator head

Notes:

- The clearance for fitting and subsequent operation of the door must be complied with.
- Due to the low threshold height, the ground in front of the garage must be level or sloped to guarantee smooth opening of the wicket door (opening outwards) - see page 48.
- For doors up to RM 2250 in S-panelled versions or in S, M or L-ribbed versions and with top glazing type D, S and M, the distance from FFL to the bottom edge of the lintel must be equal to or greater than the ordering size (RM). Deviating sizes on request!
- For DE > RM + 285 mm an additional 120 × 60 mm extrusion is required to strengthen the suspension construction in the area of the torsion springs.
- Not possible as LPU 67 Thermo.

Note:

* For doors under thermal loads, the operator is to be fitted 40 mm higher if applicable (RM + 125 + 40).

ProMatic, SupraMatic E, P and HT	V ₁	W
With short boom (K) up to door height 2125	2775	3200
With medium boom (M) up to door height 2375	3025	3450
With long boom (L) up to door height 3000	3700	4125
With special length boom on request		

Track Application: N

(LPU 42) wicket door with threshold rail

N: Normal track application

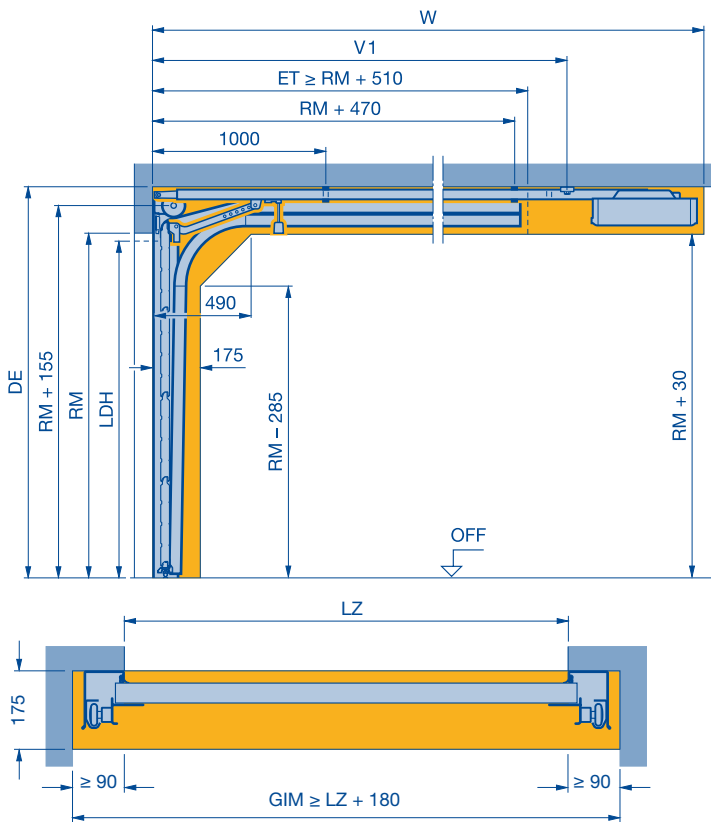

RM Height	Manual operation		With operator		
	Min. DE	LDH	Min. DE*	Min. DE with Thermo Frame set 1-2	LDH
	RM + 220	RM - 100	RM + 235	RM + 255	RM - 70
1875	2095	1775	2110	2130	1805
1955	2175	1855	2190	2210	1885
2000	2220	1900	2235	2255	1930
2080	2300	1980	2315	2335	2010
2125	2345	2025	2360	2380	2055
2205	2425	2105	2440	2460	2135
2250	2470	2150	2485	2505	2180
2375	2595	2275	2610	2630	2305
2500	2720	2400	2735	2755	2430
2625	2845	2525	2860	2880	2555
2750	2970	2650	2985	3005	2680
2875	3095	2775	3110	3130	2805
3000	3220	2900	3235	3255	2930

LDH Clear passage height

RM Grid height

LZ Clear frame dimensions

DE Ceiling height

Max. DE standard suspension = $RM + 515$

Max. DE with track suspension set = $RM + 740$

ET Distance back

GIM Inside garage dimension

V₁ Rear operator boom suspension

W Total distance back including operator head

Notes:

- The clearance for fitting and subsequent operation of the door must be complied with.
- Due to the low threshold height, the ground in front of the garage must be level or sloped to guarantee smooth opening of the wicket door (opening outwards) - see page 48.
- For doors up to 2250 mm in S-panelled versions or in S, M or L-ribbed versions and with top glazing type D, S and M, the distance from FFL to the bottom edge of the lintel must be equal to or greater than the ordering size (RM). Deviating sizes on request!
- Not possible as LPU 67 Thermo.

Note:

* For doors under thermal loads, the operator is to be fitted 40 mm higher if applicable ($RM + 235 + 40$).

ProMatic, SupraMatic E, P and HT	V ₁	W
With short boom (K) up to door height 2250	2775	3200
With medium boom (M) up to door height 2500	3025	3450
With long boom (L) up to door height 3000	3700	4125
With special length boom on request		

Track Application: L

(LPU 42) wicket door with threshold rail

L: Low headroom track application

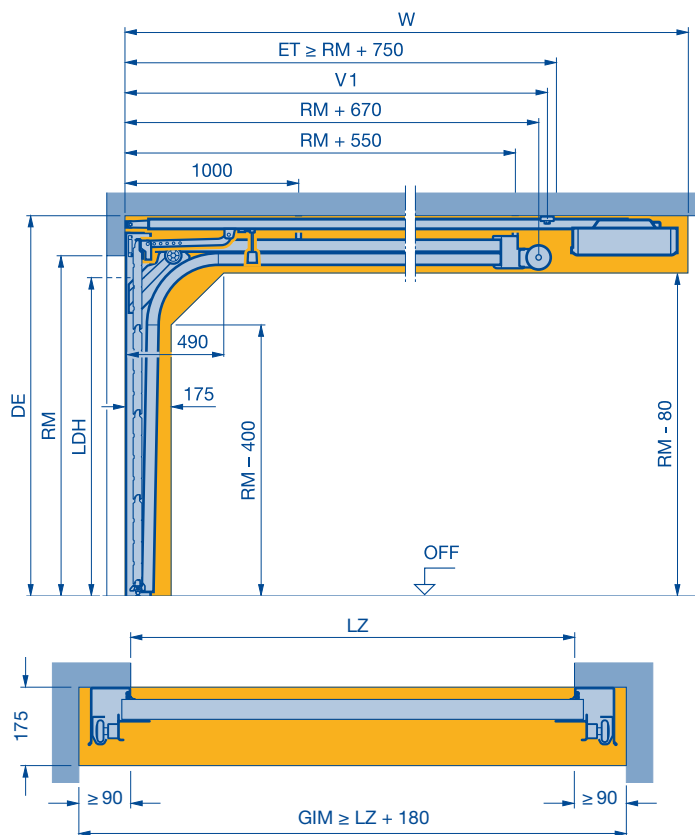

RM Height	Manual operation		With operator		
	Min. DE	LDH	Min. DE*	Min. DE with Thermo Frame set 1-2	LDH
	RM + 125	RM - 150	RM + 125	RM + 145	RM - 120
1875*	2000	1725	2000	2020	1755
1955	2080	1805	2080	2100	1835
2000	2125	1850	2125	2145	1880
2080	2205	1930	2205	2225	1960
2125	2250	1975	2250	2270	2005
2205	2330	2055	2330	2350	2285
2250	2375	2100	2375	2395	2130
2375	2500	2225	2500	2520	2255
2500	2625	2350	2625	2645	2380
2625	2750	2475	2750	2770	2505
2750	2875	2600	2875	2895	2630
2875	3000	2725	3000	3020	2755
3000	3125	2850	3125	3145	2880

* These versions are only available for S/L-ribbed doors

LDH Clear passage height

RM Grid height

LZ Clear frame dimensions

DE Ceiling height

Max. DE standard suspension = RM + 400

Max. DE with track suspension set = RM + 740 mm

ET Distance back

GIM Inside garage dimension

V₁ Rear operator boom suspension

W Total distance back including operator head

Notes:

- The clearance for fitting and subsequent operation of the door must be complied with.
- Due to the low threshold height, the ground in front of the garage must be level or sloped to guarantee smooth opening of the wicket door (opening outwards) - see page 48.
- For doors up to RM 2250 in S-panelled versions or in S, M or L-ribbed versions and with top glazing type D, S and M, the distance from FFL to the bottom edge of the lintel must be equal to or greater than the ordering size (RM). Deviating sizes on request!
- For DE > RM + 285 an additional 120 x 60 extrusion is required to strengthen the suspension construction in the area of the torsion springs.
- Not possible as LPU 67 Thermo.

Note:

* For doors under thermal loads, the operator is to be fitted 40 mm higher if applicable (RM + 125 + 40).

ProMatic, SupraMatic E, P and HT	V ₁	W
With short boom (K) up to door height 2125	2775	3200
With medium boom (M) up to door height 2375	3025	3450
With long boom (L) up to door height 3000	3700	4125
With special length boom on request		

Track Application: BZ

BZ: Track application Z / Track application for fascia panel flush-fitting

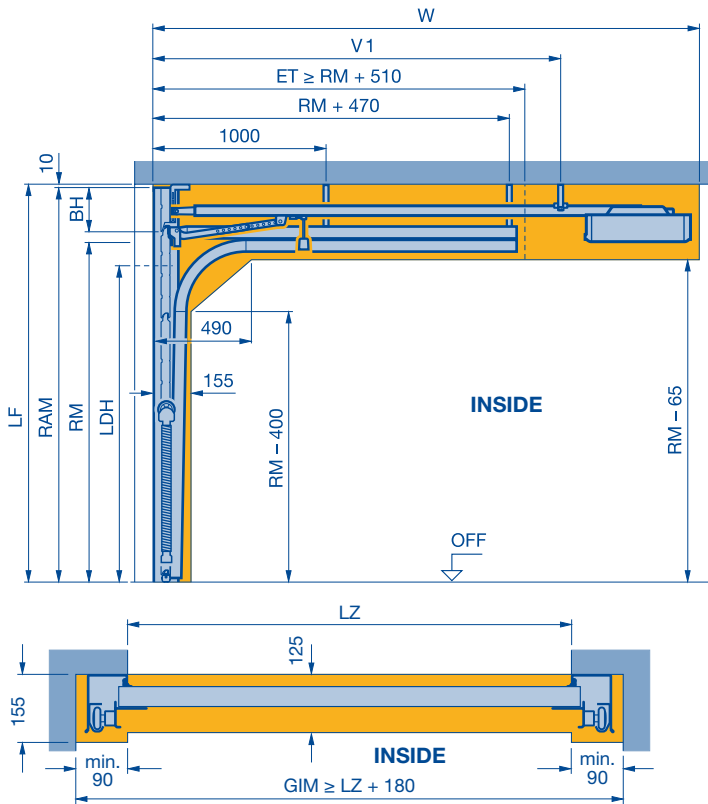

RM Height	RAM		Manual operation	With operator
	Min. RM + 190	Max.	LDH RM - 80	LDH RM - 30
1875	2065	2360	1795	1845
1955	2145	2460	1875	1925
2000	2190	2520	1920	1970
2080	2270	2620	2000	2050
2125	2375	2675	2045	2095
2205	2395	2770	2125	2175
2250	2440	2830	2170	2220
2375	2565	2870	2295	2345
2500	2690	3020	2420	2470
2625	2815	3170	2545	2595

- LDH** Clear passage height
- RM** Grid height
- LZ** Clear frame dimensions
- DE** Ceiling height
- ET** Min. distance back = RM + 440
- GIM** Inside garage dimension
- BH** Panel height
- RAM** Overall frame dimension = ordering size
Min. RAM = RM + 190
Max. RAM = 3189
- LF** Structural opening
- V₁** Rear operator boom suspension
- W** Total distance back including operator head

Notes:

- The clearance for fitting and subsequent operation of the door must be complied with.
- Shortened top door section or top aluminium frame is not possible.
- Intermediate sizes possible, shortened from bottom.
- Not possible as LPU 67 Thermo.

ProMatic	V ₁	W
With short boom (K) up to door height 2125	2847	3272
With medium boom (M) up to door height 2375	3097	3522
With long boom (L) up to door height 3000	3772	4197
With special length boom on request		

Clearance for lintel fitting with flush-fitting panel

Without lintel

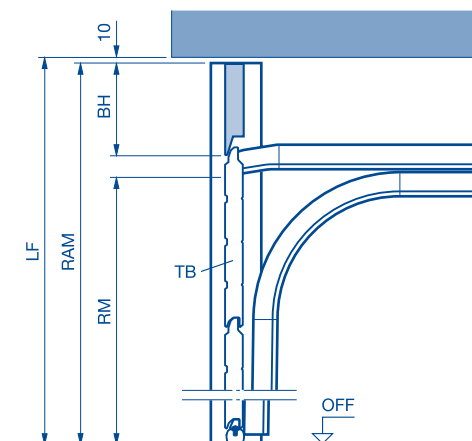

With lintel

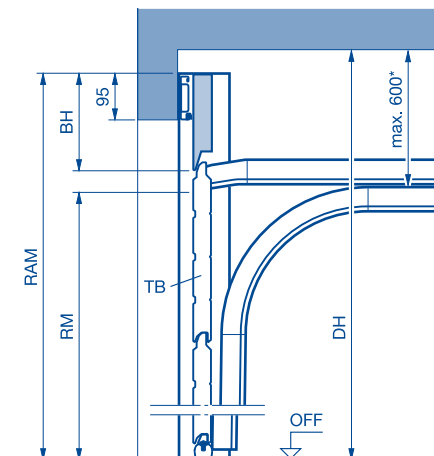

Track application	Panel version
BZ and BL	PU fascia, S, M and L-ribbed
	S-panelled on request

- DH** Ceiling height
- RAM** Bottom edge of lintel + 95 mm
- TB** Door leaf
- * Suspension = DH - RM = max. 600 mm

RAM LF - 10 mm

Track Application: BL

BL: track application L / track application for flush-fitting panel

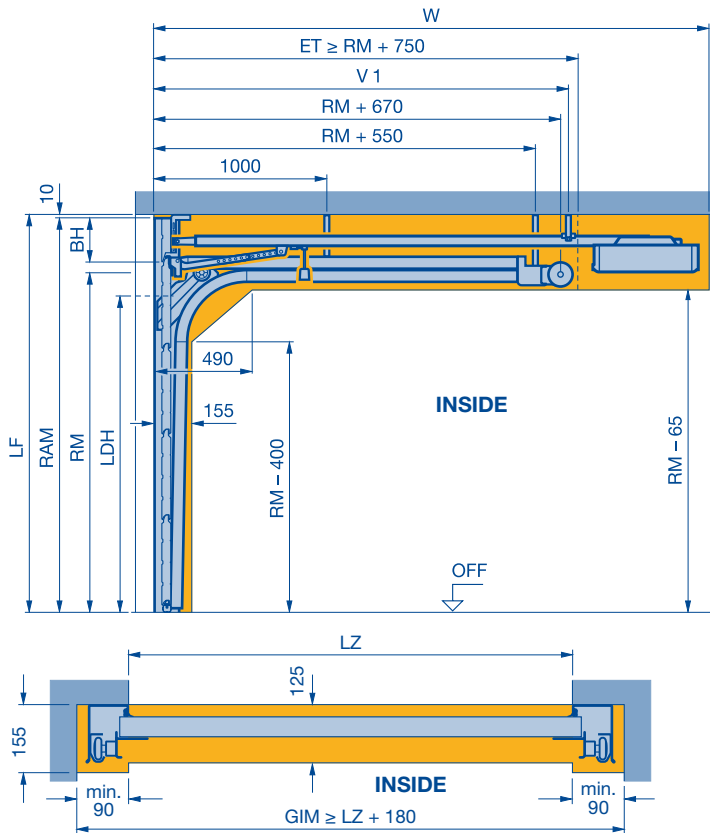

RM Height	RAM		Manual operation	With operator	
	Min.	Max.	LDH	LDH up to LZ ≤ 3000	LDH from LZ ≥ 3010
	RM + 190		RM - 100	RM - 30	RM - 80
1875	2065	2360	1775	1845	1795
1955	2145	2460	1855	1925	1875
2000	2190	2520	1900	1970	1920
2080	2270	2620	1980	2050	2000
2125	2315	2675	2025	2095	2045
2205	2395	2770	2105	2175	2125
2250	2440	2830	2150	2220	2170
2375	2565	2870	2275	2345	2295
2500	2690	3020	2400	2470	2420
2625	2815	3170	2525	2595	2545
2750	2940	3320	2650	2720	2670
2875	3065	3373	2775	2845	2795
3000	3190	3520	2900	2970	2920

- LDH** Clear passage height
- RM** Grid height
- LZ** Clear frame dimensions
- DE** Ceiling height
- ET** Distance back
- GIM** Inside garage dimension
- BH** Panel height
- RAM** Overall frame dimension = ordering size
Min. RAM = RM + 190
Max. RAM = 3539
- LF** Structural opening
- V₁** Rear operator boom suspension
- W** Total distance back including operator head

Notes:

- The clearance for fitting and subsequent operation of the door must be complied with.
- Shortened top door section or top aluminium frame is not possible.
- Intermediate sizes possible, shortened from bottom.
- Not possible as LPU 67 Thermo.

ProMatic, SupraMatic E, P and HT	V ₁	W
With short boom (K) up to door height 2125	2847	3272
With medium boom (M) up to door height 2375	3097	3522
With long boom (L) up to door height 3000	3772	4197
With special length boom on request		

Clearance for lintel fitting with flush-fitting panel

Without lintel

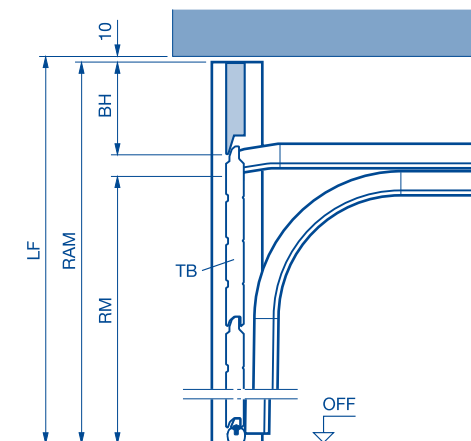

With lintel

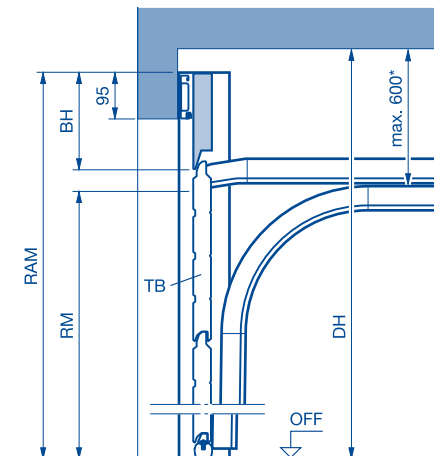

Track application	Panel version
BZ and BL	PU fascia, S, M and L-ribbed
	S-panelled on request

- DH** Ceiling height
- RAM** Bottom edge of lintel + 95 mm
- TB** Door leaf
- * Suspension = DH - RM = max. 600 mm

RAM LF-10 mm

Track Application: BL

(LPU 42) wicket door with trip-free threshold

BL: track application L / track application for flush-fitting panel

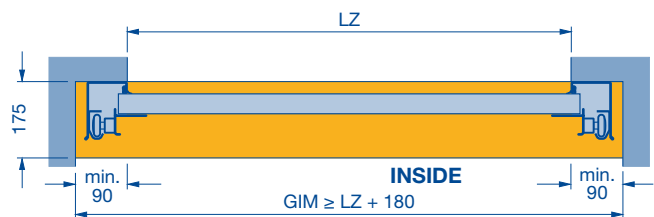
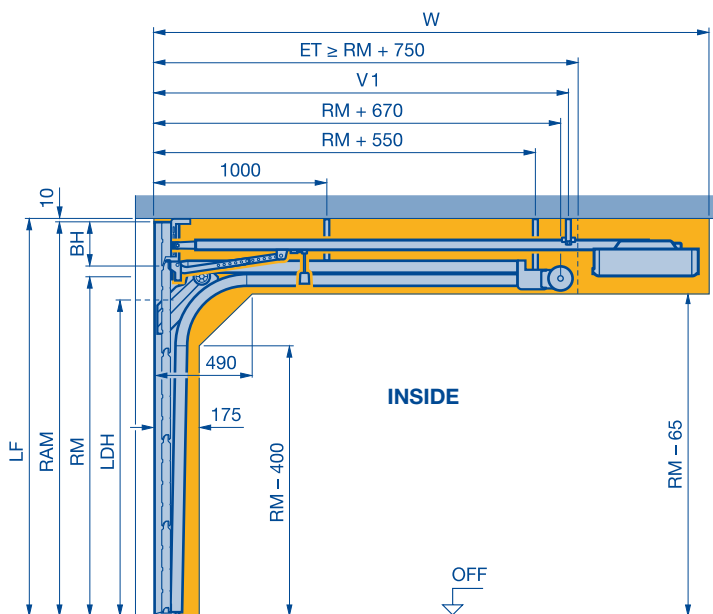

RM Height	RAM		Manual operation	With operator
	Min. RM + 190	Max.	LDH RM - 160	LDH RM - 160
1875	2065	2360	1715	1715
1955	2145	2460	1795	1795
2000	2190	2520	1840	1840
2080	2270	2620	1920	1920
2125	2315	2675	1965	1965
2205	2395	2770	2045	2045
2250	2440	2830	2090	2090
2375	2565	2870	2215	2215
2500	2690	3020	2340	2340
2625	2815	3170	2465	2465
2750	2940	3320	2590	2590
2875	3065	3373	2715	2715
3000	3190	3520	2840	2840

- LDH** Clear passage height
- RM** Grid height
- LZ** Clear frame dimensions
- DE** Ceiling height
- ET** Distance back
- GIM** Inside garage dimension
- BH** Panel height
- RAM** Overall frame dimension = ordering size
Min. RAM = RM + 190
Max. RAM = 3539
- LF** Structural opening
- V₁** Rear operator boom suspension
- W** Total distance back including operator head

Notes:

- The clearance for fitting and subsequent operation of the door must be complied with.
- Due to the low threshold height, the ground in front of the garage must be level or sloped to guarantee smooth opening of the wicket door (opening outwards) - see page 48.
- Shortened top door section or top aluminium frame is not possible.
- Not possible as LPU 67 Thermo.

ProMatic, SupraMatic E, P and HT	V ₁	W
With short boom (K) up to door height 2125	2847	3272
With medium boom (M) up to door height 2375	3097	3522
With long boom (L) up to door height 3000	3772	4197
With special length boom on request		

Clearance for lintel fitting with flush-fitting panel

Without lintel

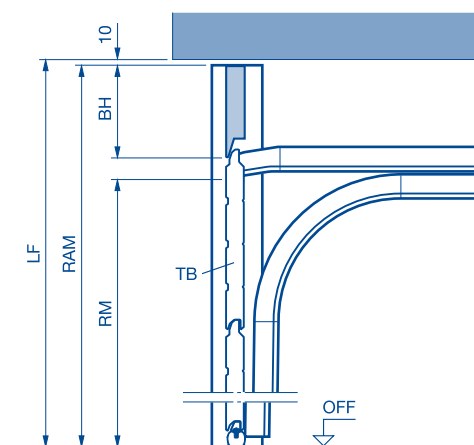

With lintel

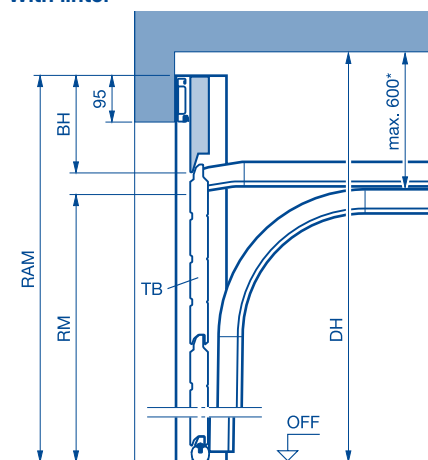

Track application	Panel version
BZ and BL	PU fascia, S, M and L-ribbed
	S-panelled on request

- DH** Ceiling height
- RAM** Bottom edge of lintel + 95 mm
- TB** Door leaf
- * Suspension = DH - RM = max. 600 mm

RAM LF - 10 mm

Track application: Z

Fitting in front of the reveal

Z: Tension spring track application

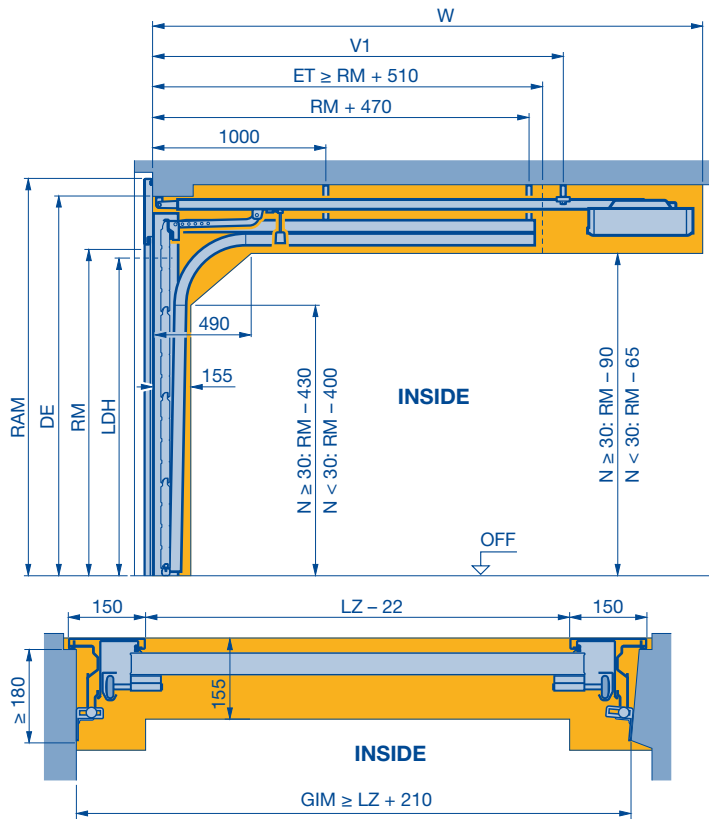

RM Height	N ≥ 30			
	Manual operation		With operator	
	Min. DE RM + 75	LDH RM - 110	Min. DE RM + 90	LDH RM - 60
1875	1950	1765	1965	1815
1955	2030	1845	2045	1895
2000	2075	1890	2090	1940
2080	2155	1970	2170	2020
2125	2200	2015	2215	2065
2205	2280	2095	2295	2145

RM Height	N < 30			
	Manual operation		With operator	
	Min. DE RM + 100	LDH RM - 80	Min. DE RM + 115	LDH RM - 30
1875	1975	1795	1990	1845
1955	2055	1875	2070	1925
2000	2100	1920	2115	1970
2080	2180	2000	2195	2050
2125	2225	2045	2240	2095
2205	2305	2125	2320	2175

- LDH** Clear passage height
- RM** Grid height
- LZ** Clear frame dimensions
- DE** Ceiling height
- ET** Distance back
- GIM** Inside garage dimension
- N** Height difference between interior and exterior garage floor
- RAM** Overall frame dimension
- RAM** Min. = RM + 115 mm
- height** Max. = RM + 185 mm
- V₁** Rear operator boom suspension
- W** Total distance back including operator head

Examples for fitting situation

With N ≥ 30 mm

LDH = RM - 110 mm without operator

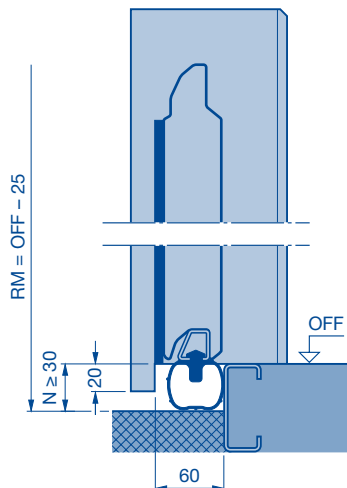

With N < 30 mm

LDH = RM - 80 mm without operator

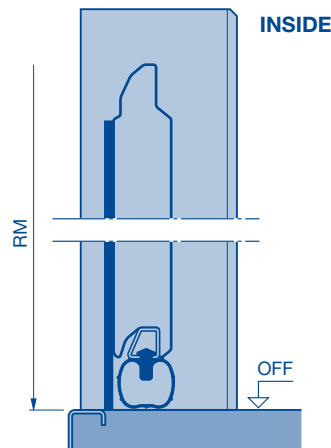

Distance back without operator:

RM + 510 mm

Notes:

- The clearance for fitting and subsequent operation of the door must be complied with.
- Not possible as LPU 67 Thermo.

ProMatic, SupraMatic E, P and HT	V ₁	W
With short boom (K) up to door height 2125	2775	3200
With medium boom (M) up to door height 2375	3025	3450

Sideroom

Track applications Z, N, L, H

Normal track application, **sideroom 90 mm**, fixing inside the frame

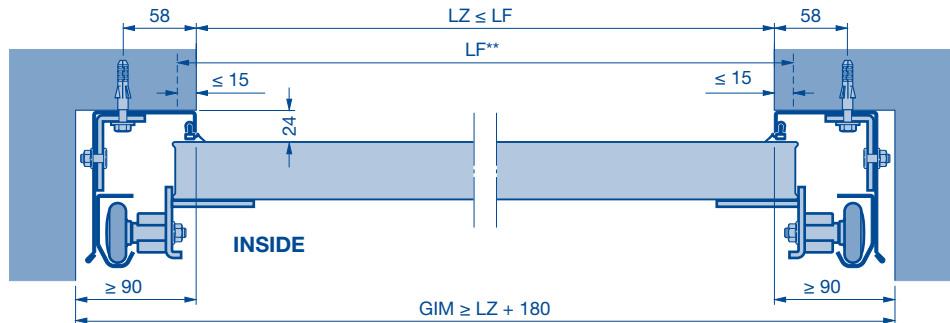

Sideroom less than 75 mm, or without sideroom. Frame fixing with special anchor

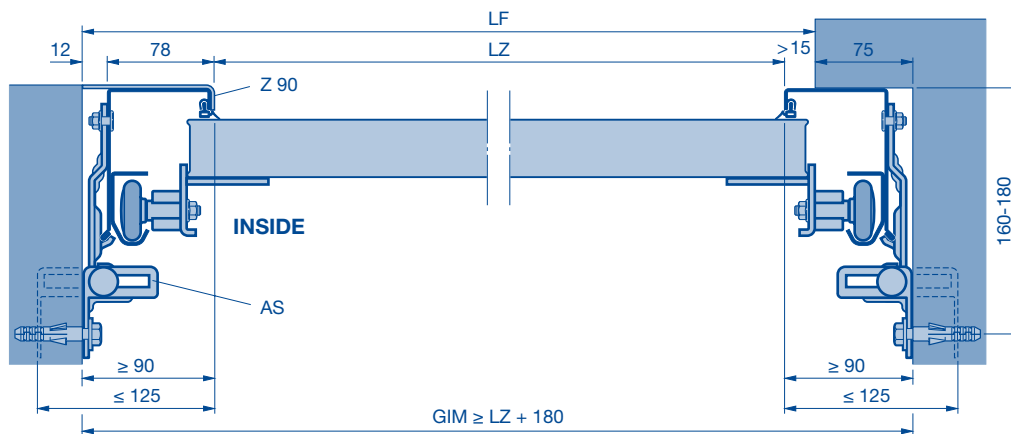

Min. sideroom 75 mm, fixing outside the frame

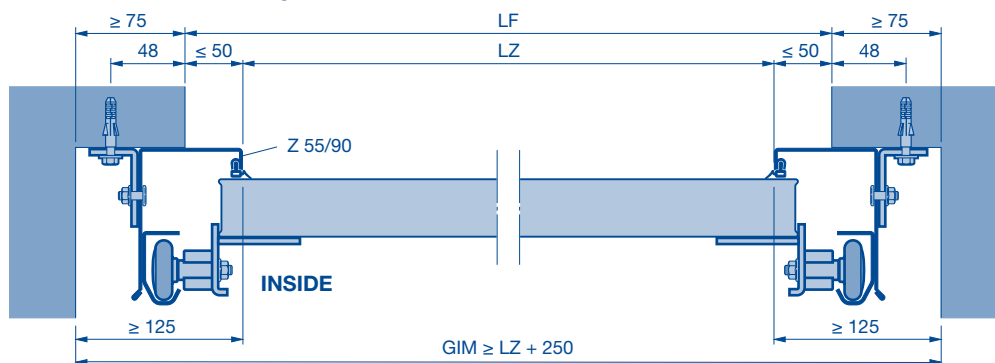

Frame fixing to tube with fixed element using special anchor

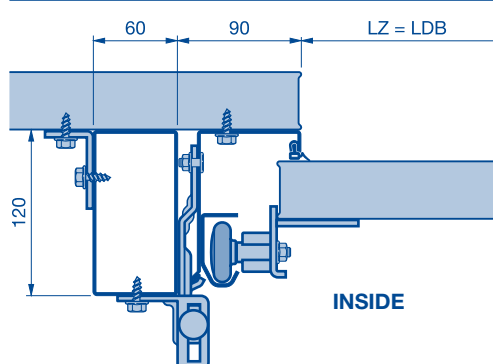

Frame fixing when using a thermal insulation composite system

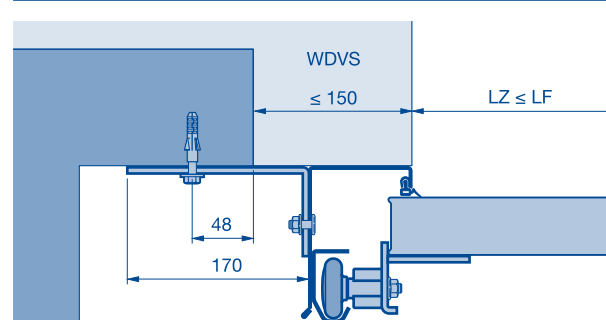

(See next page for the legend)

Sideroom and lintel fitting with ThermoFrame

Track applications Z, N, L, H with ThermoFrame

Normal track application, **sideroom 90 mm**, fixing inside the frame

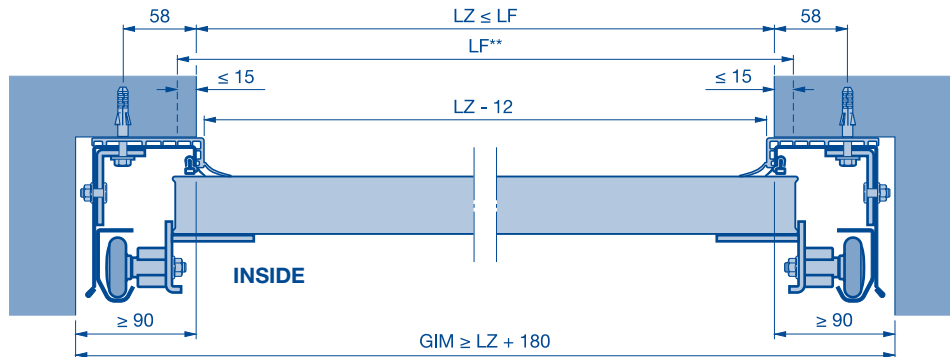

Sideroom less than 75 mm, or without sideroom. Frame fixing with special anchor

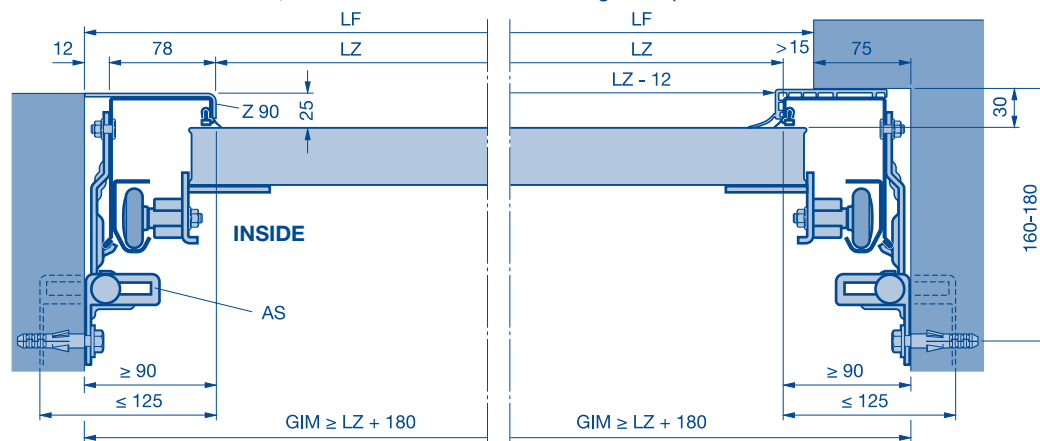

Lintel fitting with ThermoFrame

LPU 42 (set 1-3)

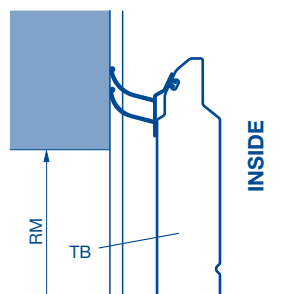

LPU 42 (set 4-5)

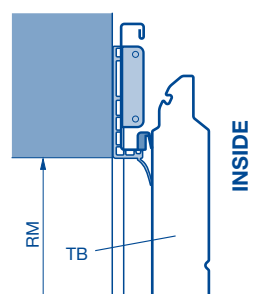

LPU 67 Thermo (set 6-7)

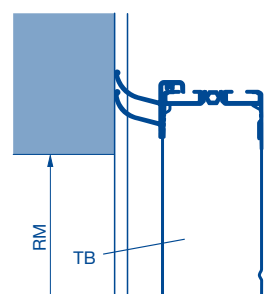

LPU 67 Thermo with aluminium frame (set 8-9)

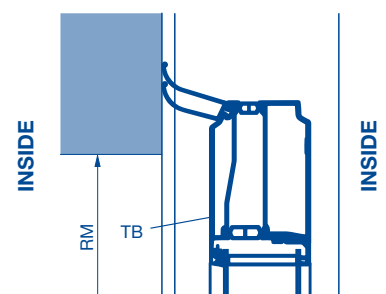

* Min.
** Max.
LZ Clear frame dimensions
LF Structural opening
GIM Inside garage dimension
Z 55 Frame covering 55

Z 90 Frame covering 90 mm
AS Special anchor
RAMB Overall frame dimension width
TB Door leaf
WDVS Thermal insulation composite system

Sideroom

Fitting in front of the reveal

Fitting in front of the reveal

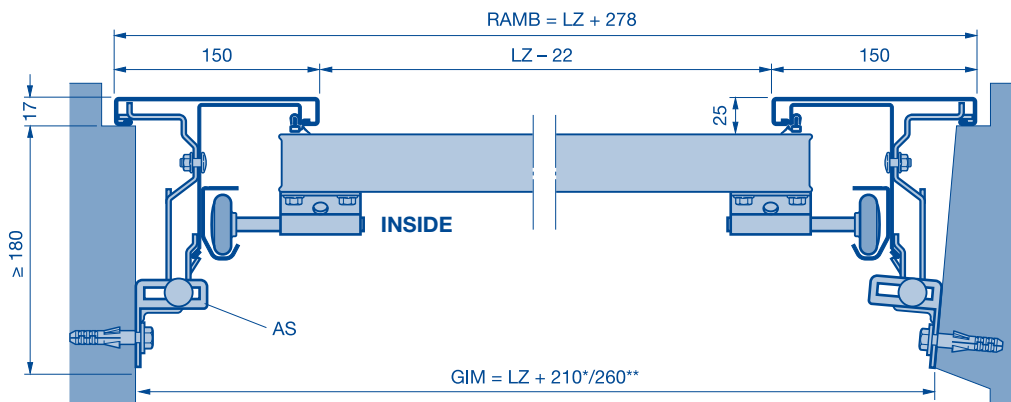

Fitting in the opening

Fascia frame -95-

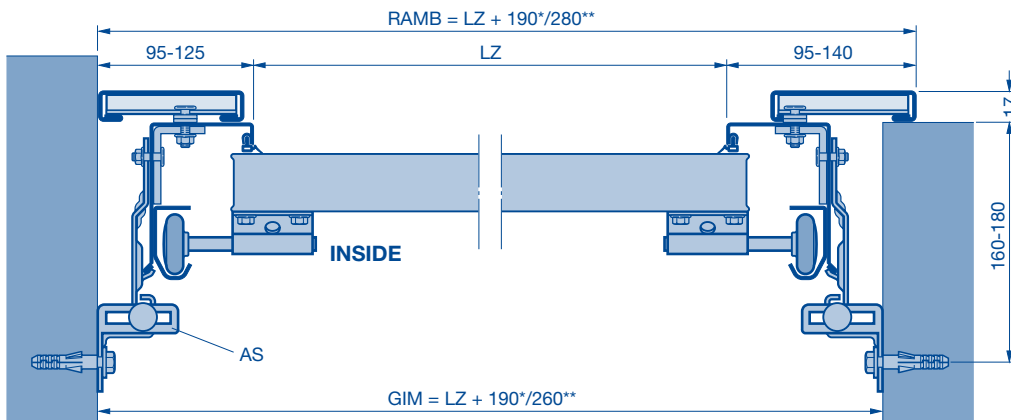

Fitting behind the opening

Retrofit fascia

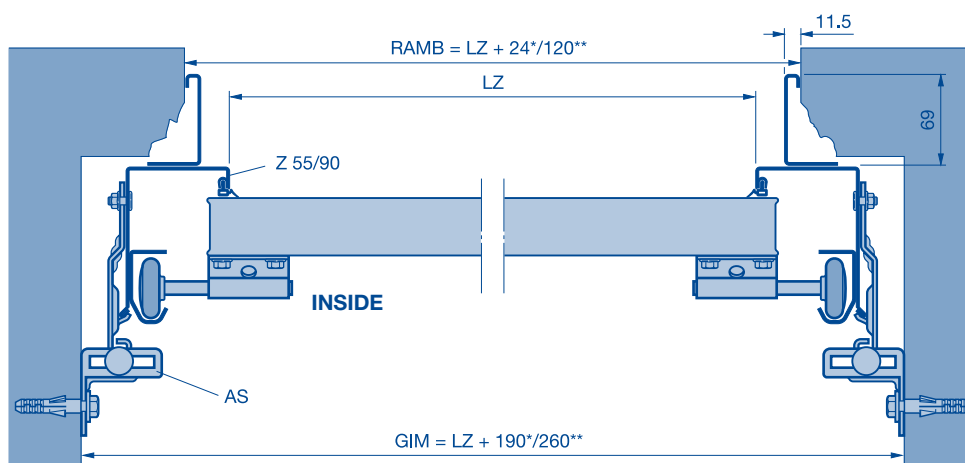

* Min.
 ** Max.
 LZ Clear frame dimensions
 LF Structural opening
 GIM Inside garage dimension
 Z 55 Frame covering 55

Z 90 Frame covering 90
 AS Special anchor
 RAMB Overall frame dimension width
 TB Door leaf

Lintel fitting with fascia panels

LTE 42, LPU 42, LPU 67 Thermo

View A
LTE 42, LPU 42

LPU 67 Thermo

View B

View C

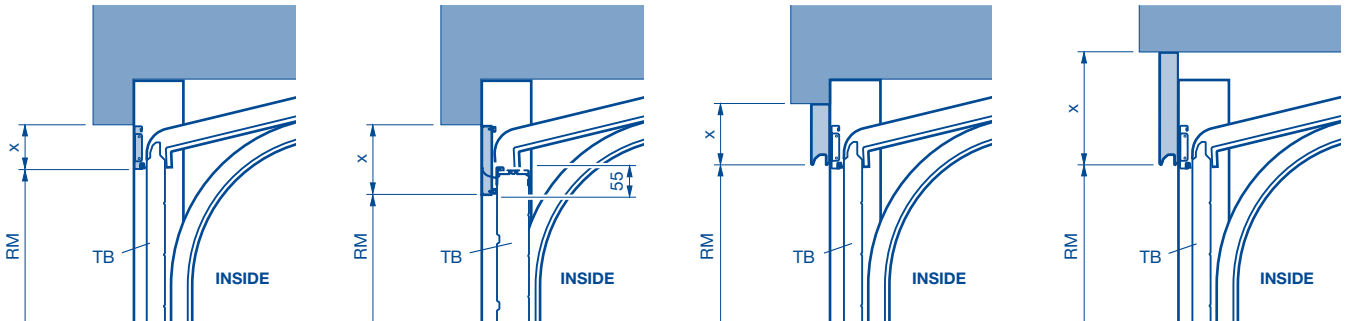

Track application	Panel version	Dimension x		
		View A	View B	View C
Z, N and L	Steel fascia (in scope of delivery)	Up to 100 mm	-	-
	PU fascia, S/L-ribbed	-	61 – 562 mm	61 – 562 mm
	PU panel, M-ribbed	-	250 – 562 mm	250 – 562 mm
	PU fascia, S-panelled	-	-	468, 475, 479, 488, 500, 520, 525, 531, 550, 562

LTH 42 (A steel fascia is included in the scope of delivery for LTH 42 doors!)

View A

View B

View C

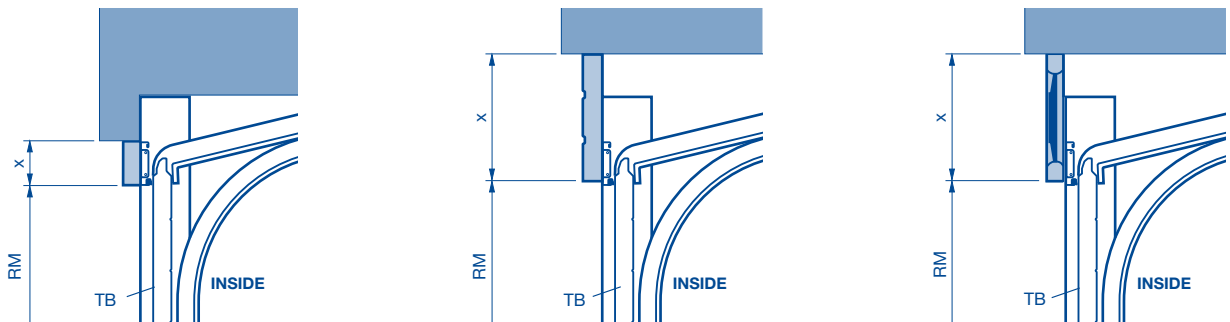

Track application	Panel version	Dimension x		
		View A	View B	View C
N and L	Smooth timber panel	31 – 290 mm	-	-
	Timber panel, S-ribbed	-	146 – 562 mm	-
	Timber panel, V-panelled	-	-	291 – 562 mm

LTE 42, LPU 42

Retrofit fascias

Aluminium fascia panel

Fascia frame -95-

Angle section

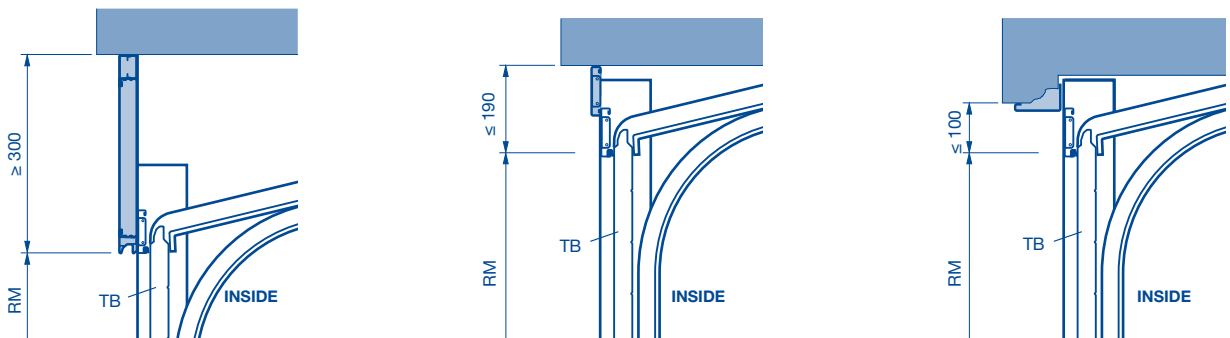

Attention:

Observe the frame's plug and screw fitting points in the lintel area, since they are subject to an increased torque with track application N (torsion spring).

TB	Door leaf	LDH	Clear passage height
RM	Grid height	LF	Structural opening

Bottom Edge

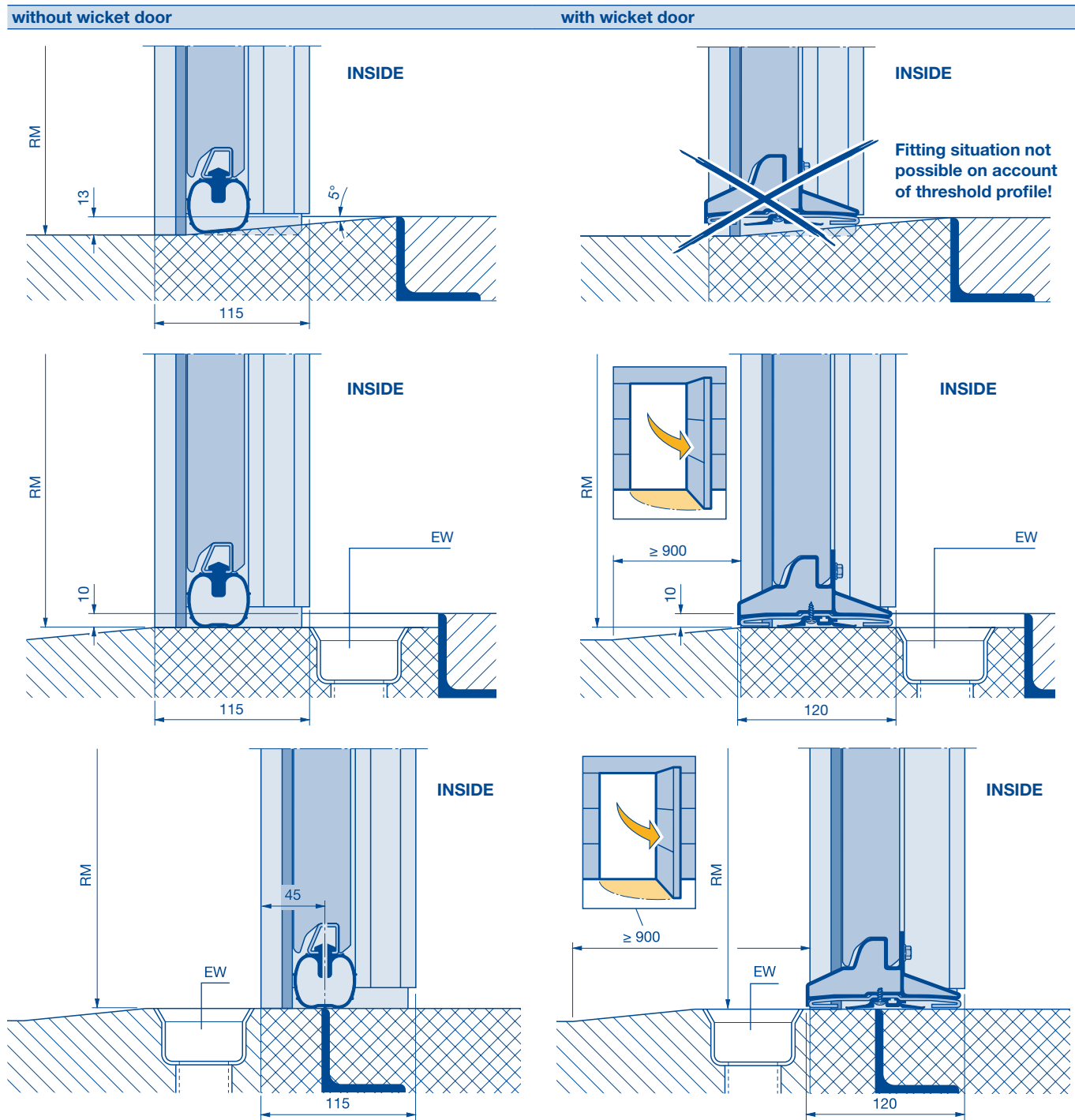

Chamfered height adjustment of the bottom door section

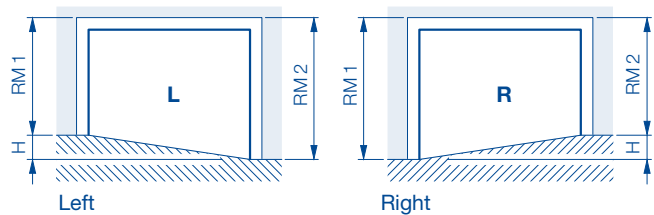

Chamfered bottom section – view of fitting side (from inside)

H = Height difference max. 300 mm

Notes:

- Only possible for LPU 42 with track application N or L up to LZ ≤ 4500 mm!
- Not for versions with wicket door or panelled doors!
- LDH reduced by H.
- Min. RM 1 / RM 2 = 2000 mm.

EW Drainage
LDH Clear passage height
RM Grid

Bottom Edge LPU 67 Thermo

without wicket door

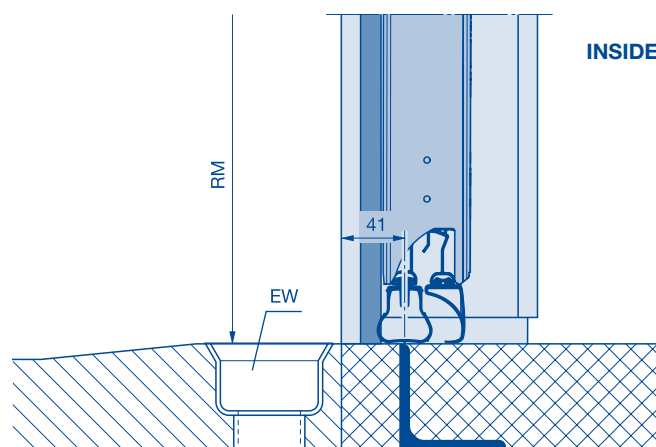
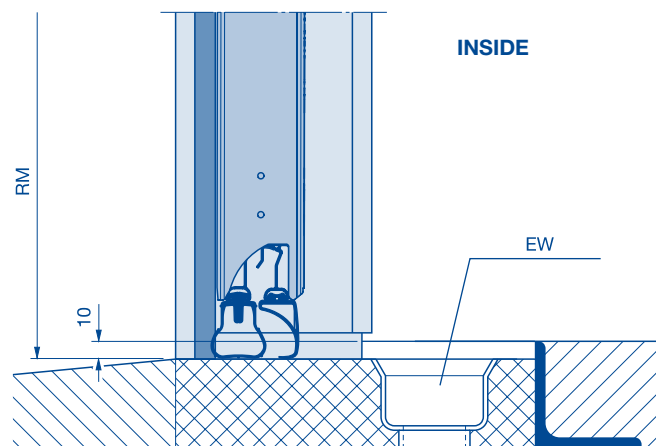
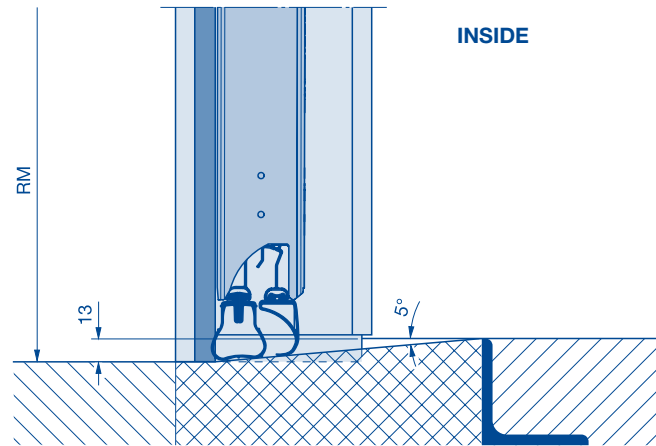

EW Drainage
RM Grid

Fixed Elements

External views

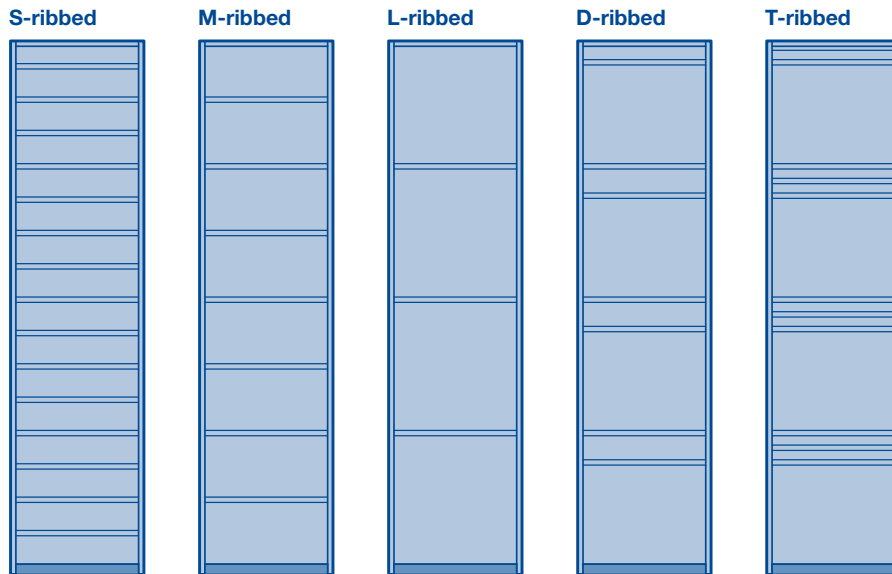

Possible fitting types

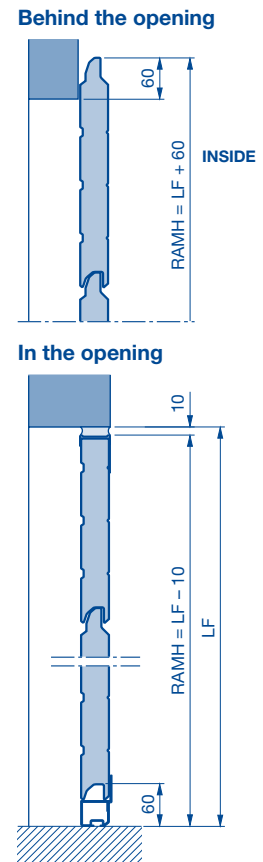

Fitting examples

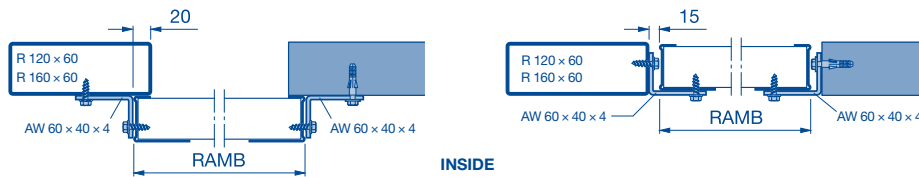

Height table of ribbed versions

B	RM	A	In the opening		Behind the opening
			Min. RAMH	Max. RAMH	RAMH
468	1875	1	100	506	528
468	1875	2	568	974	997
468	1875	3	1036	1442	1466
468	1875	4	1504	1910	1935
468	1875	5	1972	2378	2403
468	1875	6	2440	2846	2872
475	2375	1	100	513	535
475	2375	2	575	988	1010
475	2375	3	1050	1463	1485
475	2375	4	1525	1938	1960
475	2375	5	2000	2413	2435
475	2375	6	2475	2888	2910
479	2875	1	100	517	539
479	2875	2	579	996	1058
479	2875	3	1058	1475	1497
479	2875	4	1537	1954	1976
479	2875	5	2016	2433	2455
479	2875	6	2495	2912	2935
488	1955	1	100	526	548
488	1955	2	588	1014	1037
488	1955	3	1076	1502	1526
488	1955	4	1564	1990	2015
488	1955	5	2052	2478	2503
488	1955	6	2540	2966	2992
500	2000, 2500, 3000	1	100	538	560
500	2000, 2500, 3000	2	600	1038	1060
500	2000, 2500, 3000	3	1100	1538	1560
500	2000, 2500, 3000	4	1600	2038	2060
500	2000, 2500, 3000	5	2100	2538	2560
500	2000, 2500, 3000	6	2600	3038	3060

B	RM	A	In the opening		Behind the opening
			Min. RAMH	Max. RAMH	RAMH
520	2080	1	100	558	580
520	2080	2	620	1078	1100
520	2080	3	1140	1598	1620
520	2080	4	1660	2118	2140
520	2080	5	2180	2638	2660
520	2080	6	2700	3158	3180
525	2625	1	100	563	585
525	2625	2	625	1088	1110
525	2625	3	1150	1613	1635
525	2625	4	1675	2138	2160
525	2625	5	2200	2663	2685
525	2625	6	2725	3188	3210
531	2125	1	100	569	591
531	2125	2	631	1100	1122
531	2125	3	1162	1631	1653
531	2125	4	1693	2162	2185
531	2125	5	2224	2663	2716
531	2125	6	2755	3224	3247
550	2205, 2750	1	100	588	610
550	2205, 2750	2	650	1138	1160
550	2205, 2750	3	1200	1688	1710
550	2205, 2750	4	1750	2238	2260
550	2205, 2750	5	2300	2788	2810
550	2205, 2750	6	2850	3338	3360
562	2250	1	100	600	622
562	2250	2	662	1162	1185
562	2250	3	1224	1724	1747
562	2250	4	1786	2286	2310
562	2250	5	2348	2848	2872
562	2250	6	2910	3410	3435

Note:

RAMB at least 135 mm.

Not possible in Silkgrain, Sandgrain, Decograin and Micrograin
A No. of door sections

B Door section height
AW Aluminium angle
LF Structural opening

RAMB Overall frame width
RAMH Overall frame height
RM Grid height

Side Doors NT 60

With corner frame made of aluminium profiles

Standard/special sizes

External views

(The illustrations correspond to the size of the structural opening for 1000 × 2125 mm. Deviations may occur with other door sizes.)

* For possible design elements, see page 18 for L-ribbed doors in Silkgrain and Sandgrain (number of elements based on technical feasibility)

Profile type 1

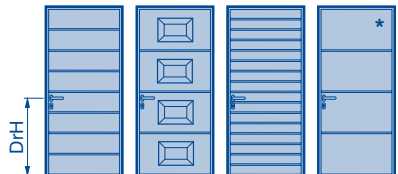

Profile type 2

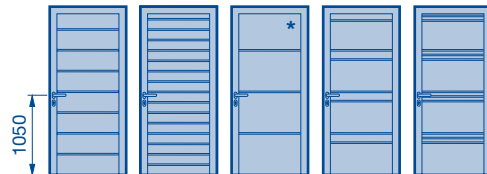

Standard sizes

Profile type 1, only opening inwards, S, M, L-ribbed or S-panelled
Fitting: internal fitting

Ordering sizes = BRB	DrH from FFL	B
875 × 2000	955	500
875 × 2125	1010	531
1000 × 2000	955	500
1000 × 2125	1010	531

Profile type 2 S-, M-, L-ribbed
Fitting: internal or external fitting

Ordering sizes = BRB	DrH from FFL	B
875 × 2000	1050	500
875 × 2125	1050	531
1000 × 2000	1050	500
1000 × 2125	1050	531

Special sizes

Profile type 1 internal fitting S-, M-, L-ribbed						
B	RM	A	BRB*	Min. BRH	Max. BRH	DrH
468	1875	4	550-1284	1800	1935	898
475	2375	4	550-1284	1800	1963	911
479	2875	4	550-1284	1800	1979	917
488	1955	4	550-1284	1800	2015	934
500	2000	4	550-1284	1800	2063	955
520	2080	4	550-1284	1800	2143	990
525	2625	4	550-1284	1800	2163	1000
531	2125	4	550-1284	1800	2187	1010
550	2205/2750	4	550-1284	1800	2263	1043
562	2250	4	550-1284	1804	2311	1064
468	1875	5	550-1284	1990	2403	898
475	2375	5	550-1284	2018	2438	911
479	2875	5	550-1284	2034	2458	917
488	1955	5	550-1284	2070	2500	934
500	2000	5	550-1284	2118	2500	955
520	2080	5	550-1284	2198	2500	990
525	2625	5	550-1284	2218	2500	1000
531	2125	5	550-1284	2242	2500	1010
550	2205/2750	5	550-1284	2318	2500	1043
562	2250	5	550-1284	2366	2500	1064

Profile type 2 internal or external fitting S, M, L-ribbed***						
B	RM	A	BRB*	Min. BRH**	Max. BRH	DrH
468	1875	4	550-1284	1800	1958	1050
475	2375	4	550-1284	1800	1986	1050
479	2875	4	550-1284	1800	2002	1050
488	1955	4	550-1284	1800	2038	1050
500	2000	4	550-1284	1800	2086	1050
520	2080	4	550-1284	1800	2166	1050
525	2625	4	550-1284	1800	2186	1050
531	2125	4	550-1284	1800	2210	1050
550	2205/2750	4	550-1284	1800	2286	1050
562	2250	4	550-1284	1804	2334	1050
468	1875	5	550-1284	1990	2426	1050
475	2375	5	550-1284	2018	2461	1050
479	2875	5	550-1284	2034	2481	1050
488	1955	5	550-1284	2070	2500	1050
500	2000	5	550-1284	2118	2500	1050
520	2080	5	550-1284	2198	2500	1050
525	2625	5	550-1284	2218	2500	1050
531	2125	5	550-1284	2242	2500	1050
550	2205/2750	5	550-1284	2318	2500	1050
562	2250	5	550-1284	2366	2500	1050

Profile type 1 internal fitting, S-panelled						
B	RM	A	BRB**	Min. BRH*	Max. BRH	DrH
468	1875	4	633-1284	1886	1935	898
475	2375	4	633-1284	1911	1963	911
479	2875	4	633-1284	1925	1979	917
488	1955	4	633-1284	1956	2015	934
500	2000	4	633-1284	1998	2063	955
520	2080	4	633-1284	2068	2143	990
525	2625	4	633-1284	2086	2163	1000
531	2125	4	633-1284	2107	2187	1010
550	2205/2750	4	633-1284	2173	2263	1043
562	2250	4	633-1284	2215	2311	1064
468	1875	5	633-1284	2354	2403	898
475	2375	5	633-1284	2386	2438	911
479	2875	5	633-1284	2404	2458	917
488	1955	5	633-1284	2444	2500	934
500	2000	5	633-1284	2498	2500	955

* Glazing min. BRB: aluminium frame = 550 mm, S window (S-, M-, L-ribbed) = 603 mm, S window (S-panelled) = 633 mm, M window = 828 mm, D window = 888 mm

** BRH < 1800 only with profile type 2 and DRH = BRH/2 possible on request

*** 3-point locking from BRH > 1960 mm

Note:

Smaller doors possible on request.

A No. of door sections
B Door section height
BRB Nominal size-width

BRH Nominal size-height
DrH Lever height
RM Grid height

Side Doors NT 60

With corner frame made of aluminium profiles

Standard/special sizes

Profile type 1
(only opening inwards)

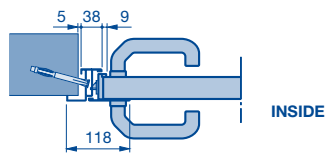

Profile type 2
(opening inwards)

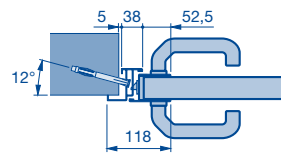

Profile type 2
(opening outwards)

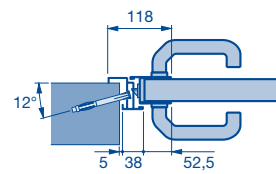

Internal fitting

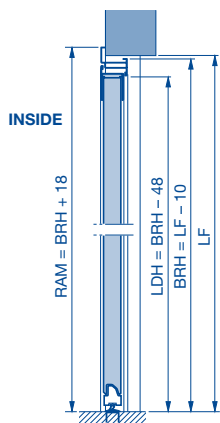

External fitting

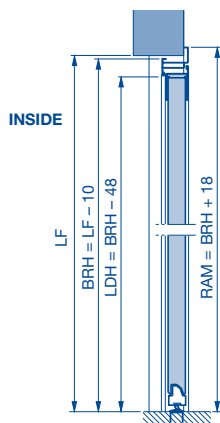

Internal fitting (opening inwards), profile type 1 or 2

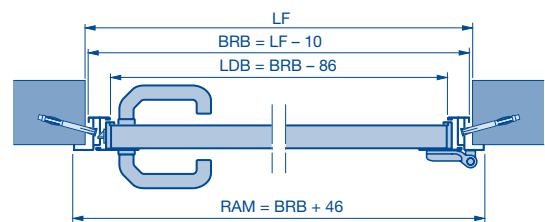
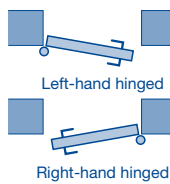

External fitting (opening outwards), profile type 2

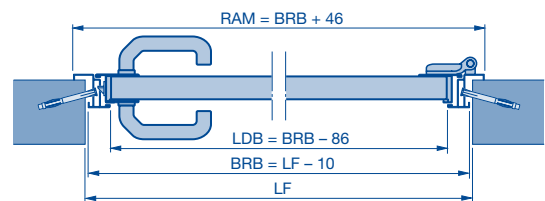
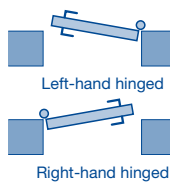

Profile type 1, 2

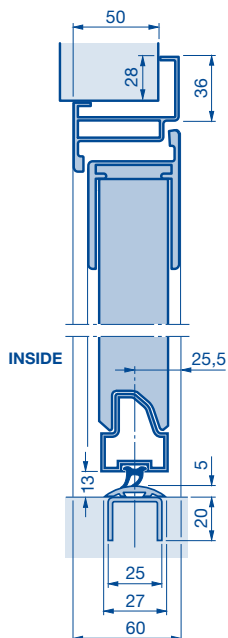

BRB Nominal size-width
BRH Nominal size-height
LDB Clear passage width

LDH Clear passage height
LF Structural opening
RAM Overall frame dimension

Side Doors NT 60

With block frame made of aluminium profiles

Standard sizes

External views

(The illustrations correspond to the size of the structural opening for 1000 × 2125 mm. Deviations may occur with other door sizes.)

* For possible design elements, see page 18 for L-ribbed doors in Silkgrain and Sandgrain (number of elements based on technical feasibility)

Profile type 1

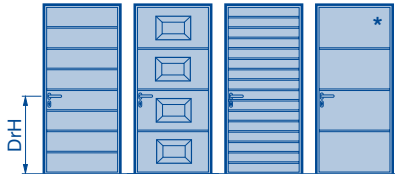

Profile type 2

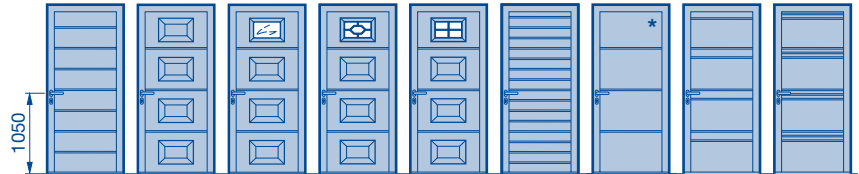

Standard sizes (profile type 1, only opening inwards)

Profile type 1 (fitting behind the opening), S-, M-, L-ribbed, S-panelled			
LF of the opening	Ordering sizes = RAM	DrH from FFL	B
855–875 × 1990–2000	990 × 2058	955	500
855–875 × 2115–2125	990 × 2183	1010	531
980–1000 × 1990–2000	1115 × 2058	955	500
980–1000 × 2115–2125	1115 × 2183	1010	531

Profile type 2 (fitting behind the opening), S-, M-, L-ribbed, S-panelled			
LF of the opening	Ordering sizes = RAM	DrH from FFL	B
855–875 × 1990–2000	990 × 2058	1050	500
855–875 × 2115–2125	990 × 2183	1050	531
980–1000 × 1990–2000	1115 × 2058	1050	500
980–1000 × 2115–2125	1115 × 2183	1050	531

Profile type 2 (fitting in the opening), S, M, L-ribbed***			
LF of the opening	Ordering sizes = RAM	DrH from FFL	B
875 × 2000	855 × 1990	1050	500
875 × 2125	855 × 2115	1050	531
1000 × 2000	980 × 1990	1050	500
1000 × 2125	980 × 2115	1050	531

Note with glazing type D: min. RAM width 935 mm

(See next page for the legend)

B Door section height
DrH Lever height
LF Structural opening
RAM Overall frame dimension

Side Doors NT 60

With block frame made of aluminium profiles

Standard sizes

Profile type 1

Profile type 2

Profile type 1/2

Profile type 1/2
Panel in front of the side door

Profile type 1/2
Panel over the side door

Profile type 1/2

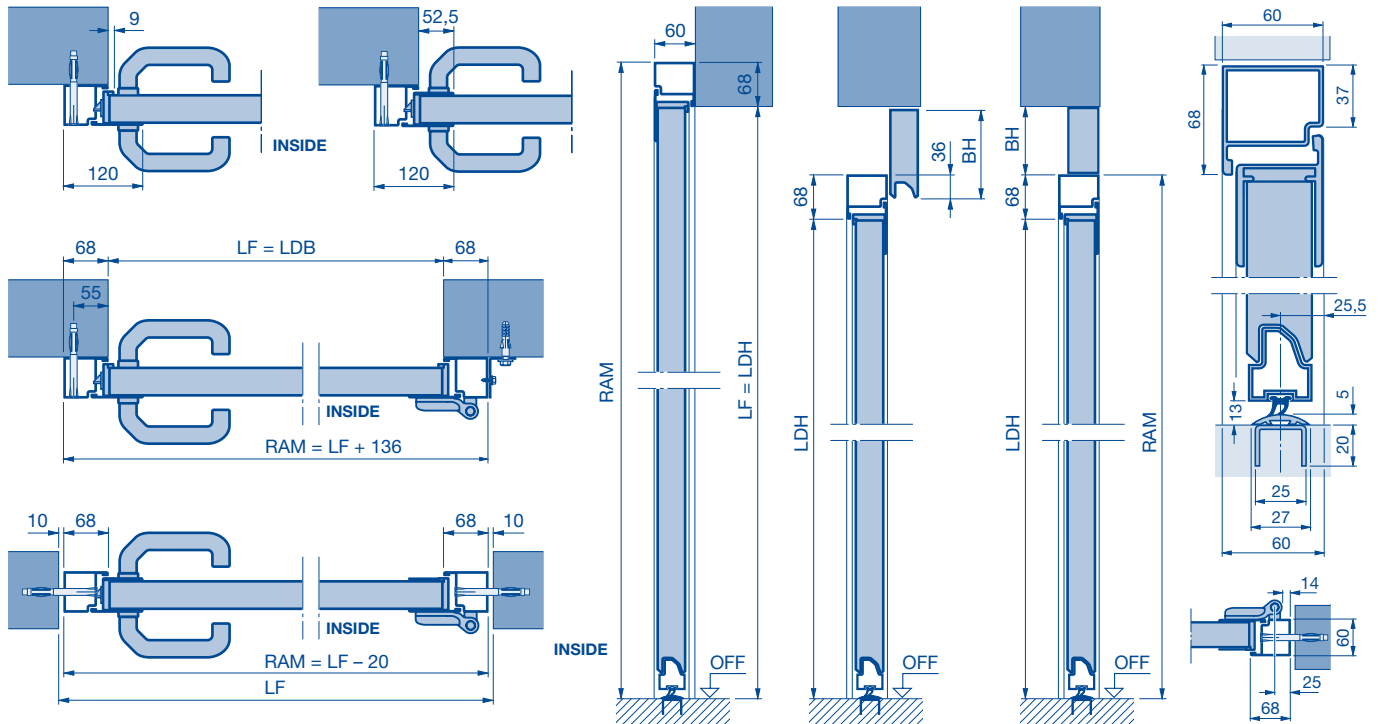

Fitting arrangements

Fitting in the opening

Fitting next to the door, opening inwards or outwards, RH or LH hinged



Fitting in the opening, opening inwards or outwards, RH or LH hinged



Fitting behind the opening

Only opening inwards, RH or LH hinged

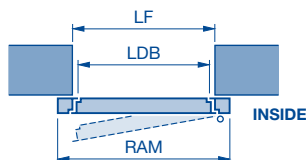

Note:

Dowel holes in the frame must be selected additionally (not standard).

BH Panel height
LDB Clear passage width
LDH Clear passage height
LF Structural opening

RAM Overall frame dimension

Side Doors NT 60

With block frame made of aluminium profiles

Special sizes

External views

(The illustrations correspond to the size of the structural opening for 1000 × 2125 mm. Deviations may occur with other door sizes.)

Profile type 2



Special sizes (profile type 1, only opening inwards)

Profile type 1 (fitting in or behind the opening), S, M, L-ribbed						
B	RM	A	RAMB*	Min. RAMH	Max. RAMH	DrH
468	1875	4	550-1330	1800	1955	898
475	2375	4	550-1330	1800	1983	911
479	2875	4	550-1330	1800	1999	917
488	1955	4	550-1330	1800	2035	934
500	2000	4	550-1330	1800	2083	955
520	2080	4	550-1330	1800	2163	990
525	2625	4	550-1330	1800	2183	1000
531	2125	4	550-1330	1800	2207	1010
550	2205/2750	4	550-1330	1800	2283	1043
562	2250	4	550-1330	1825	2331	1064
468	1875	5	550-1330	2011	2423	898
475	2375	5	550-1330	2039	2458	911
479	2875	5	550-1330	2055	2478	917
488	1955	5	550-1330	2091	2523	934
500	2000	5	550-1330	2139	2558	955
520	2080	5	550-1330	2219	2558	990
525	2625	5	550-1330	2239	2558	1000
531	2125	5	550-1330	2263	2558	1010
550	2205/2750	5	550-1330	2339	2558	1043
562	2250	5	550-1330	2387	2558	1064

Profile type 2 (fitting in or behind the opening), S, M, L-ribbed***						
B	RM	A	RAMB*	Min. RAMH**	Max. RAMH	DrH
468	1875	4	550-1330	1800	1979	1050
475	2375	4	550-1330	1800	2007	1050
479	2875	4	550-1330	1800	2023	1050
488	1955	4	550-1330	1800	2059	1050
500	2000	4	550-1330	1800	2107	1050
520	2080	4	550-1330	1800	2187	1050
525	2625	4	550-1330	1800	2207	1050
531	2125	4	550-1330	1800	2231	1050
550	2205/2750	4	550-1330	1800	2307	1050
562	2250	4	550-1330	1825	2355	1050
468	1875	5	550-1330	2011	2447	1050
475	2375	5	550-1330	2039	2482	1050
479	2875	5	550-1330	2055	2502	1050
488	1955	5	550-1330	2091	2547	1050
500	2000	5	550-1330	2139	2558	1050
520	2080	5	550-1330	2219	2558	1050
525	2625	5	550-1330	2239	2558	1050
531	2125	5	550-1330	2263	2558	1050
550	2205/2750	5	550-1330	2339	2558	1050
562	2250	5	550-1330	2387	2558	1050

Profile type 1 (fitting behind the opening), S-panelled						
B	RM	A	RAMB	Min. RAMH	Max. RAMH	DrH
468	1875	4	725-1330	1907	1955	898
475	2375	4	725-1330	1931	1983	911
479	2875	4	725-1330	1945	1999	917
488	1955	4	725-1330	1977	2035	934
500	2000	4	725-1330	2019	2083	955
520	2080	4	725-1330	2089	2163	990
525	2625	4	725-1330	2106	2183	1000
531	2125	4	725-1330	2127	2207	1010
550	2205/2750	4	725-1330	2194	2283	1043
562	2250	4	725-1330	2236	2331	1064
468	1875	5	725-1330	2375	2423	898
475	2375	5	725-1330	2406	2458	911
479	2875	5	725-1330	2424	2478	917
488	1955	5	725-1330	2465	2523	934
500	2000	5	725-1330	2519	2558	955

Profile type 2 (fitting behind the opening), S-panelled						
B	RM	A	RAMB	Min. RAMH	Max. RAMH	DrH
468	1875	4	725-1330	1949	1979	1050
475	2375	4	725-1330	1973	2007	1050
479	2875	4	725-1330	1987	2023	1050
488	1955	4	725-1330	2019	2059	1050
500	2000	4	725-1330	2061	2107	1050
520	2080	4	725-1330	2131	2187	1050
525	2625	4	725-1330	2148	2207	1050
531	2125	4	725-1330	2169	2231	1050
550	2205/2750	4	725-1330	2236	2307	1050
562	2250	4	725-1330	2278	2355	1050
468	1875	5	725-1330	2417	2447	1050
475	2375	5	725-1330	2448	2482	1050
479	2875	5	725-1330	2466	2502	1050
488	1955	5	725-1330	2507	2547	1050

* Glazing type D: min RAMB = 935 mm or panel glazing type M: min RAMB = 875 mm

** RAMH < 1800 only with profile type 2 and DRH = RAMH/2 possible on request

*** 3-point locking from RAMH > 1940 mm

Note:

Smaller doors possible on request.

A No. of door sections
B Door section height
DrH Lever height
RAMB Overall frame width

RAMH Overall frame dimension height
RM Grid height

Side Doors NT 60

With block frame made of aluminium profiles

Special sizes

Fitting next to the door, opening outwards, RH or LH hinged

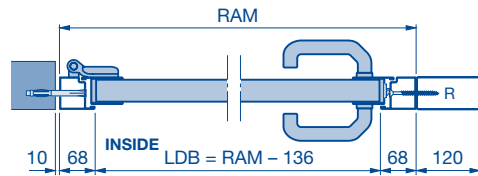

Fitting next to the door, opening inwards, RH or LH hinged

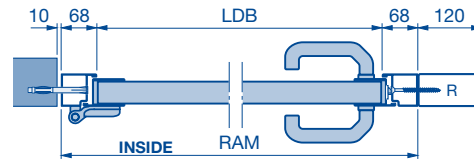

Fitting in the opening, opening inwards or outwards, RH or LH hinged

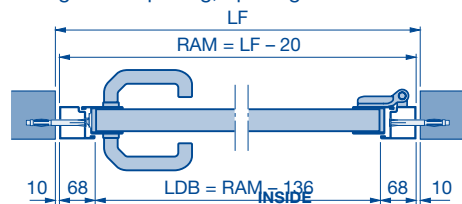

Fitting behind the opening, opening inwards, RH or LH hinged

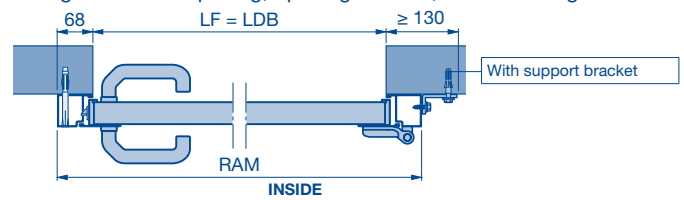

Fitting behind the opening

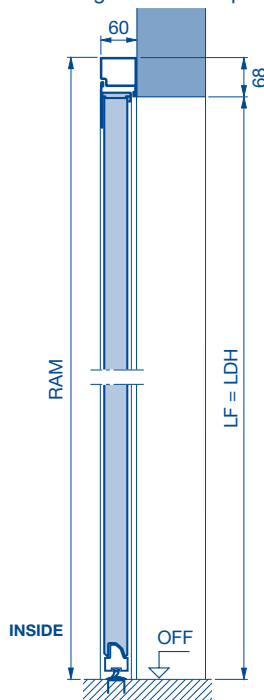

Fitting in the opening

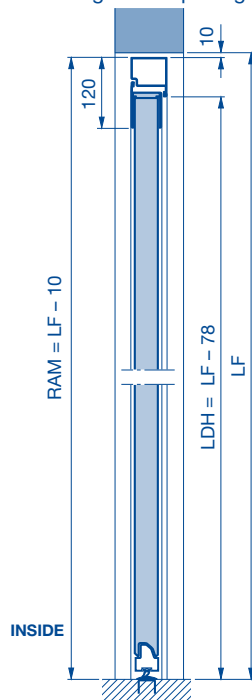

Note:

Dowel holes in the frame must be selected additionally (not standard).

DrH Lever height
LDB Clear passage width
LDH Clear passage height
LF Structural opening

R Box section
RAM Overall frame dimension

Side Doors NT 60

Double-leaf side doors with block frames made of aluminium profiles

Fitting in the opening, profile type 2, opening inwards or outwards, RH or LH hinged

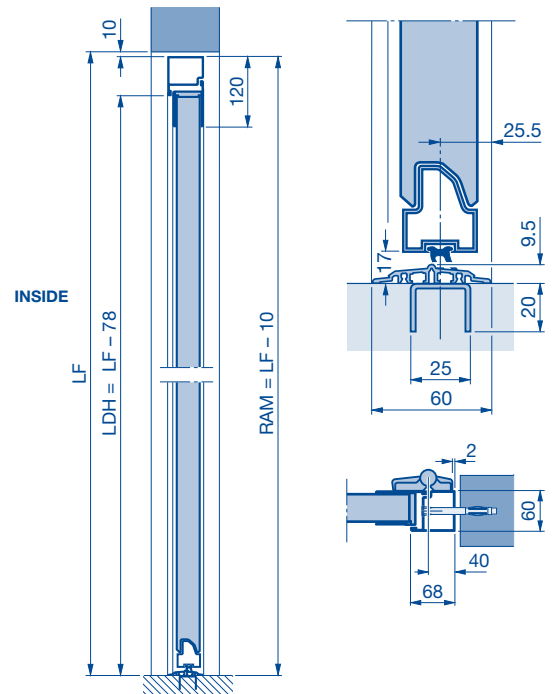
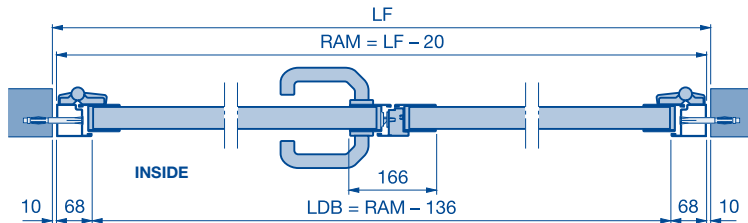

Note:

- The ground must be level or sloped to guarantee smooth opening of the double-leaf side door.
- Asymmetric division possible from $RAMB \leq 2000$ mm.
- With asymmetric division, the clear passage width for the traffic leaf is always 870 mm.
- No RC 2 possible with side door "opening inwards"!

Fitting arrangements

Fitting in the opening, opening outwards or inwards, right-hand hinged

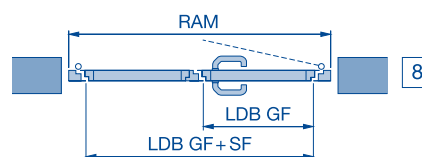
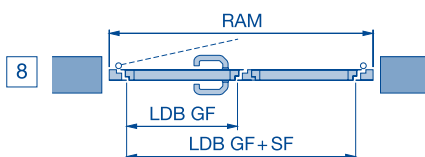

Fitting in the opening, opening outwards or inwards, left-hand hinged

Special sizes

Profile type 2 (fitting in the opening), S, M, L-ribbed***						
B	RM	A	RAMB	Min. RAMH	Max. RAMH	DrH
468	1875	4	1200-2500	1960	1979	1050
475	2375				2007	
479	2875				2023	
488	1955				2059	
500	2000				2107	
520	2080				2187	
525	2625				2207	
531	2125				2231	
550	2205 / 2750				2307	
562	2250				2355	
468	1875	5	1200-2500	2011	2447	1050
475	2375			2039	2482	
479	2875			2055	2502	
488	1955			2091	2547	
500	2000			2139	2558	
520	2080			2219	2558	
525	2625			2239	2558	
531	2125			2263	2558	
550	2205 / 2750			2339	2558	
562	2250			2387	2558	

A No. of door sections
B Door section height
DrH Lever height
LF Structural opening

LDB Clear passage width
GF Traffic leaf
SF Fixed leaf
LDH Clear passage height

RAM Overall frame dimension
RAMB Overall frame width
RAMH Overall frame height
RM Grid height

Timber Side Doors NT 60

Standard/special sizes

External views

(The illustrations correspond to the size of the structural opening for 1000 × 2125 mm. Deviations may occur with other door sizes.)

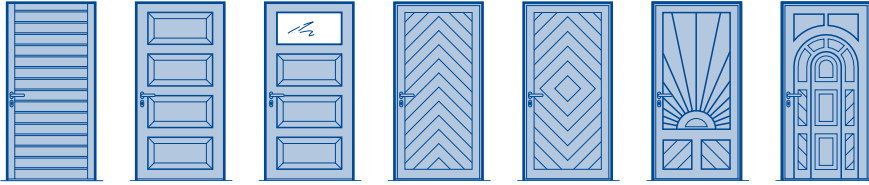

S-ribbed or V-panelled version			
Structural opening	Ordering sizes = RAM	Lever handle height from FFL	Spacing
Standard sizes			
855 – 875 × 2115 – 2125	1005 – 2190	1050	133
980 – 1000 × 2115 – 2125	1130 – 2190	1050	133
Special sizes			
	990 – 1250 × 1940 – 2315	1050	

Style version		
Structural opening	Ordering sizes = RAM	Lever handle height from FFL
Standard sizes		
980 – 1000 × 2115 – 2125	1130 – 2190	1050
Special sizes		
	1130 – 1250 × 1940 – 2315	1050

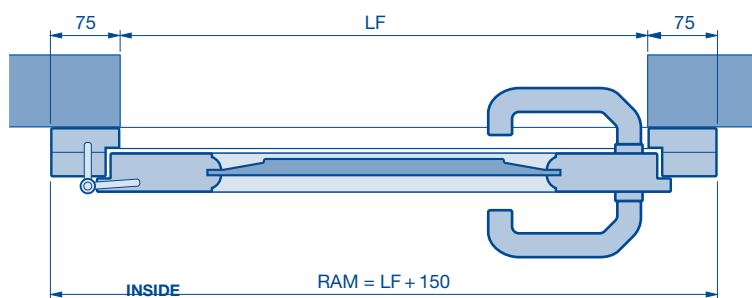
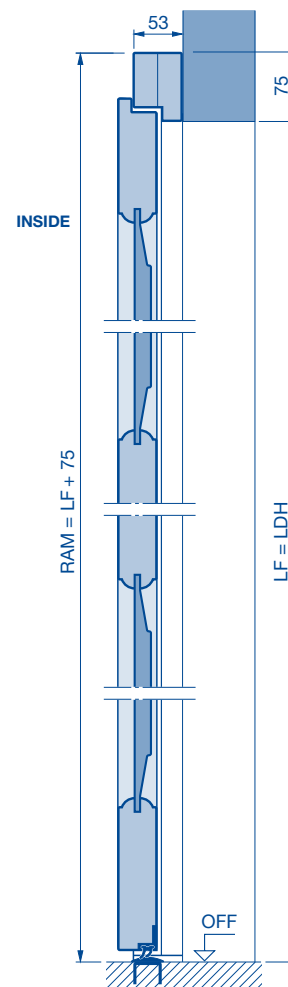

LF Structural opening
LDH Clear passage height
RAM Overall frame dimensions