

INNOVATIONS 2017



markilux 3300 pur

**Simple and straightforward design up to 400 cm extension –
with smooth front profile and wall seal**

01
02
03
04
05
06
07
08
09
10
11
12
13
14
15

folding arms
with bionic tendon
(standard)

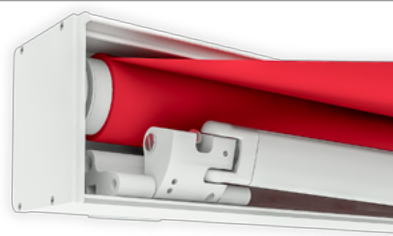

the windlock mechanism
prevents the awning
from lifting up at the
front in windy conditions

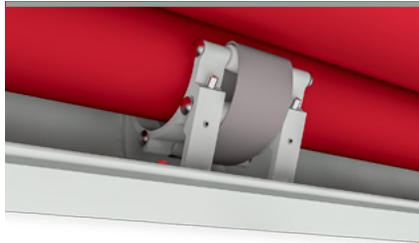

larger units are fitted
with a rolltex bearing
to prevent deflection
of the roller tube

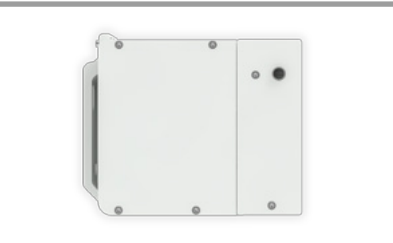

side view
face fixture

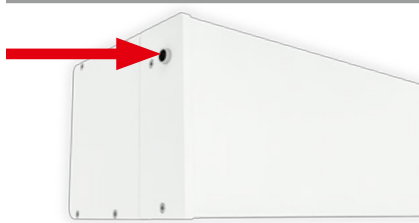

gutter with lateral
water spout



tilt device with wind
safety mechanism



side view
top fixture



detail: rubber
sealing strip with
aluminium profile

Design Features

the sturdy compact cassette with the perfect seal to the wall

elegant and robust front profile made of aluminium

self-supporting cassette made of extruded components

full cassette awning: when closed all components are fully protected from the weather

Technical Specification

the front profile with integrated double gutter ensures that water flows off to the side of the awning whether it is open or closed

the 85 mm roller tube ensures the highest stiffness and the best possible cover winding characteristics even at the largest widths

the extremely sturdy awning construction makes it possible to shade even very large areas safely

unique arm technology with power transference using bionic tendon made of high-tech fibres with extremely high tensile strength. Tested by The Fraunhofer Institute

Accessories

radio-controlled motor with radio remote control for ease of use

hard-wired motor operation (optionally with automatic weather controls) for straightforward and easy operation

in the case of manual operation ease of use is ensured with the spring-assisted gearbox

awning available in non-standard RAL colours

available with a valance

wall seal using aluminium / rubber sealing strip

Frame colours



traffic white
RAL 9016

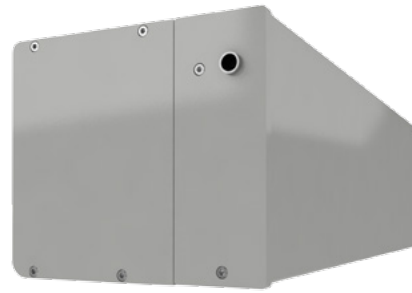

metallic aluminium
RAL 9006



off-white textured finish
5233



stone grey metallic
5215



anthracite metallic
5204



Havana brown
textured finish
5229









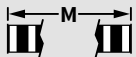
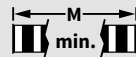

grey brown
similar to RAL 8019

- 01
- 02
- 03
- 04
- 05
- 06
- 07
- 08
- 09
- 10**
- 11
- 12
- 13
- 14
- 15

Colours similar to those in the RAL chart. Colours may differ slightly from those depicted in both hue and finish.

Dimensions and configuration options

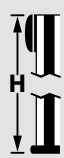
																
	250	300	350	400	450	500	550	600	650	700 ²⁾						
	190 250	251 300	301 350	351 400	401 450	451 500	501 550	551 600	601 650	651 700						
	150	3)									203	190	—	203	190	
	200	3)	3)								253	240	—	253	240	
	250	—	3)	3)							303	290	—	303	290	
	300	—	—	3)	3)						353	340	—	353	340	
	350	—	—	—	3)	3)				1) 2)	403	390	650	403	390	
	400 ²⁾	—	—	—	—	2) 3)	2) 3)	2)	2)	—	2)	453	440	700	—	—

dimensions in cm

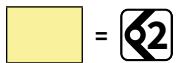
= =  =  

1) no intermediate sizes possible below the standard width of 650 cm

2) awnings with 3 arms are only available with motor (surcharge)

3) please note the minimum widths!

Operation / Drive

	Standard	Optional
manual operation	<input checked="" type="checkbox"/>	—
servo-assisted operation	—	<input checked="" type="checkbox"/>
hard-wired motor	—	<input checked="" type="checkbox"/>
io radio controls	—	<input checked="" type="checkbox"/>
silentec	—	<input checked="" type="checkbox"/> ⁴⁾
radio-controlled motor (433 MHz)	—	<input checked="" type="checkbox"/>

4) only single units with 2 folding arms

Coupled units

	Standard	Optional
2 fields	—	<input checked="" type="checkbox"/> ⁵⁾
3 fields	—	<input checked="" type="checkbox"/>
junction roller	—	<input checked="" type="checkbox"/> ⁶⁾
one-piece cover	—	<input checked="" type="checkbox"/> ⁷⁾

5) minimum widths see „Technical Information“

6) see overview „Bracket fixture range“

7) up to a maximum awning pitch of 15° and up to a maximum projection of 350 cm; on request

Miscellaneous

	Standard	Optional
bionic tendon	<input checked="" type="checkbox"/>	—
wall seal by way of aluminium + rubber sealing strip	—	<input checked="" type="checkbox"/>
insertable side blind	—	<input checked="" type="checkbox"/>
light and wind sensor	—	<input checked="" type="checkbox"/>
valance	—	<input checked="" type="checkbox"/>
infrared heater	—	<input checked="" type="checkbox"/>
vibrabox / radio control light sensor Sunis WireFree	—	<input checked="" type="checkbox"/>

Covers

	Fabric range no.	Standard	Optional
sunsilk snc	324 .. / 328 .. / 369 ..	<input checked="" type="checkbox"/>	—
sunsilk perla FR	374 ..	—	<input checked="" type="checkbox"/>
sunvas snc	310 .. / 311 .. 313 .. — 315 ..	<input checked="" type="checkbox"/>	—
sunvas perla	370 ..	—	<input checked="" type="checkbox"/>

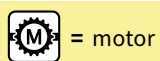

= motor



= manual operation

M = awning width

= no. of folding arms



= no. of bespoke arms

M min. = minimum widths









= no. of rolltex bearings

H = projection

Dimensions and tolerances

	Width	Projection
housing tolerances	+ 5 / - 5 mm	± 40 mm
awning cover width = awning width	- 170 mm	
awning cover length = awning projection		+ 150 mm

Frame colours

		Standard	Optional
traffic white	RAL 9016		
metallic aluminium	RAL 9006		
grey brown, similar to	RAL 8019		
off-white textured finish*	5233		
stone grey metallic*	5215		
anthracite metallic*	5204		
Havana brown textured finish*	5229		
non-standard powder-coated finish			

* = textured finish

Additional Information

The width of the awning cover is always **less** than that of the awning. Please refer cover sizes in the case of coupled units.

Pitch adjustment range:

from 5° to 45° (to the horizontal).

Definition of projection:

Please consult the section "Technical Information".

In the case of manual operation approximately **16 winding handle** revolutions can be assumed per metre of **awning projection**.

It takes approximately 12 seconds per metre to extend a **motor-driven awning**.

Coupled folding-arm awnings are available up to a max. of 3 single units side by side, however only with a maximum of 6 folding-arms and only operated by motor.

A coupled unit is available with **junction roller**. Pattern repeat mismatches are possible in the case of junction roller covers.

A junction roller may not fit when the projection is the maximum for the width of each awning. (see also the section on "Installation", the arm separation table).

Coupled folding-arm awnings with a one-piece cover on request.

If coupled blinds are fitted into a **recess or reveal** the overall width of the coupled awning must be at least 6 cm less than the width of the opening to allow the awning to be coupled.

If two single units are fitted side by side, a minimum gap of 5 cm between the units is required.

Colours similar to those in the RAL chart. Colours may differ slightly from those depicted in both hue and finish.

01 **Fixtures, fittings and accessories**

02 **Face fixture**

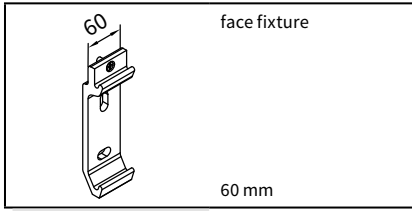

face fixture

60 mm

71995.

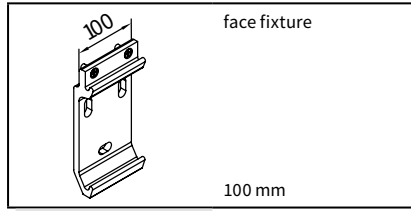

face fixture

100 mm

71994.

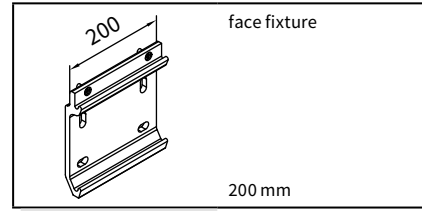

face fixture

200 mm

71996.

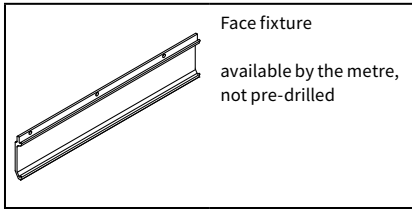

Face fixture

available by the metre,
not pre-drilled

71997.

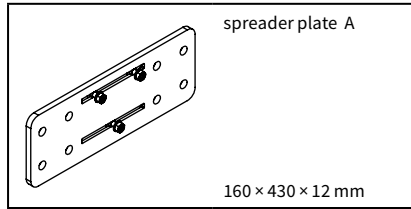

spreader plate A

160 × 430 × 12 mm

75324.

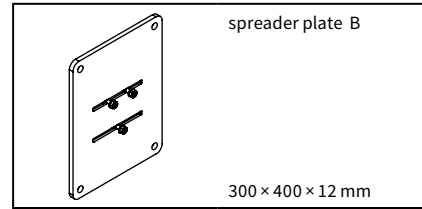

spreader plate B

300 × 400 × 12 mm

75323.

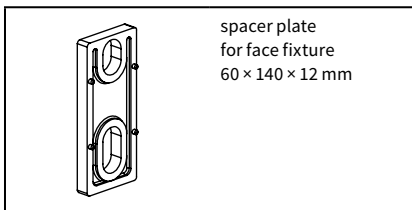

spacer plate
for face fixture
60 × 140 × 12 mm

71642.

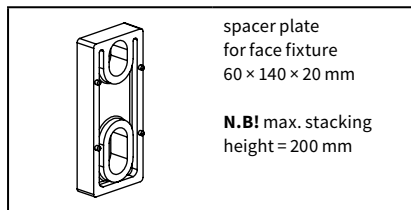

spacer plate
for face fixture
60 × 140 × 20 mm

N.B! max. stacking
height = 200 mm

716321

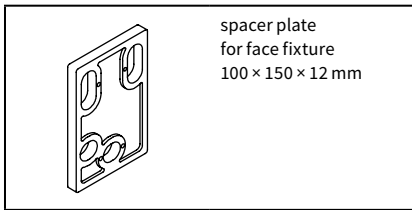

spacer plate
for face fixture
100 × 150 × 12 mm

718241

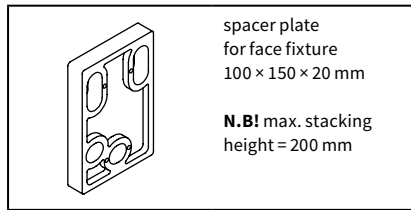

spacer plate
for face fixture
100 × 150 × 20 mm

N.B! max. stacking
height = 200 mm

718231

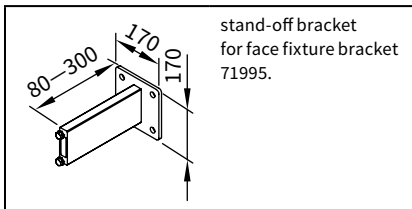

stand-off bracket
for face fixture bracket
71995.

77967.

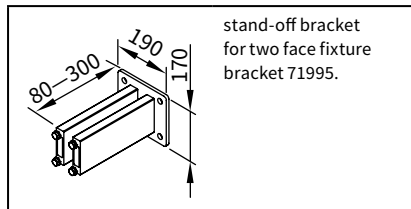

stand-off bracket
for two face fixture
bracket 71995.

77968.

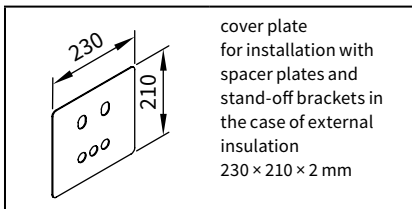

cover plate
for installation with
spacer plates and
stand-off brackets in
the case of external
insulation
230 × 210 × 2 mm

71843.

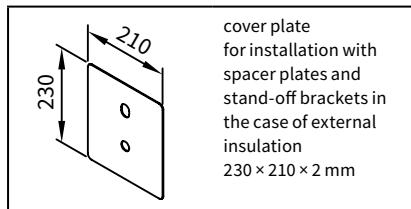

cover plate
for installation with
spacer plates and
stand-off brackets in
the case of external
insulation
230 × 210 × 2 mm

71844.

. = insert RAL colour code no

Fixtures, fittings and accessories

Top fixture

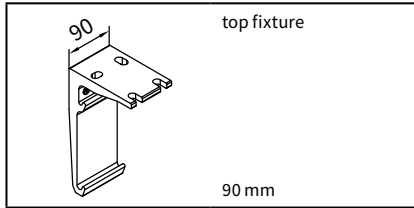

top fixture

90 mm

71651.

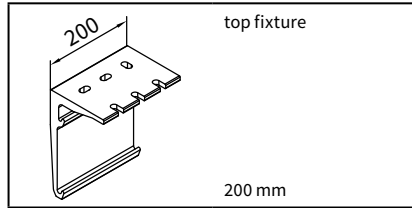

top fixture

200 mm

71652.

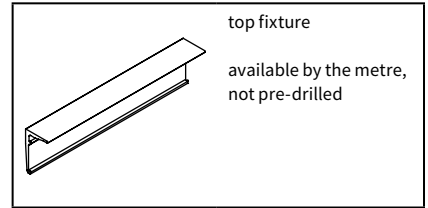

top fixture

available by the metre,
not pre-drilled

73470.

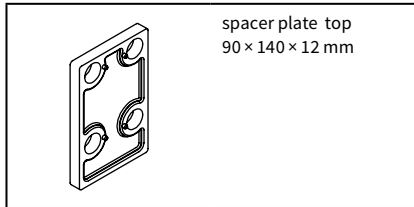

spacer plate top
90 x 140 x 12 mm

716411

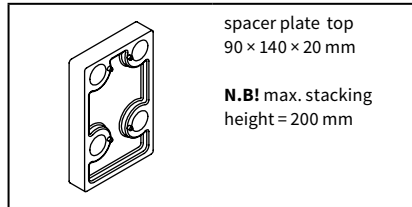

spacer plate top
90 x 140 x 20 mm

N.B! max. stacking
height = 200 mm

716311

Eaves fixture

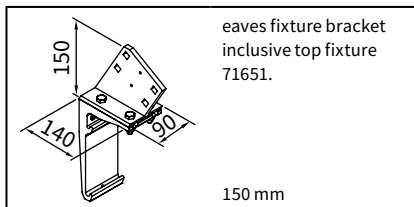

eaves fixture bracket
inclusive top fixture
71651.

150 mm

71898.

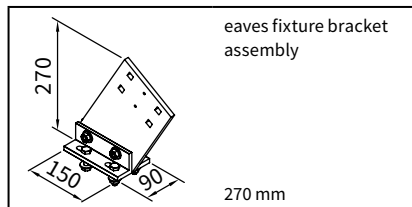

eaves fixture bracket
assembly

270 mm

71659.

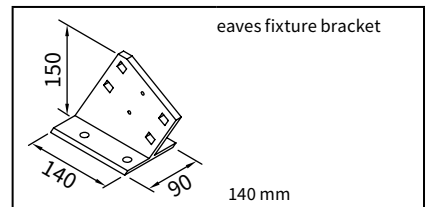

eaves fixture bracket

140 mm

71612.

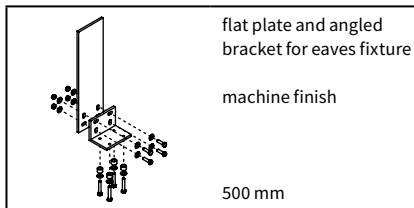

flat plate and angled
bracket for eaves fixture

machine finish

500 mm

716620

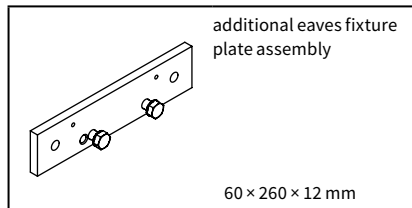

additional eaves fixture
plate assembly

60 x 260 x 12 mm

75383

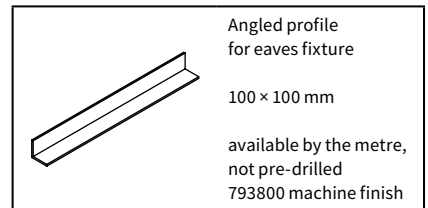

Angled profile
for eaves fixture

100 x 100 mm

available by the metre,
not pre-drilled
793800 machine finish

79380.

Accessories

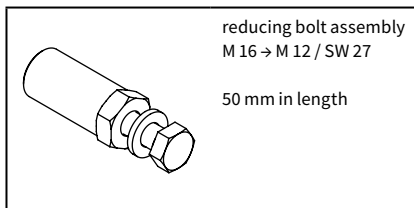

reducing bolt assembly
M 16 → M 12 / SW 27

50 mm in length

753891.

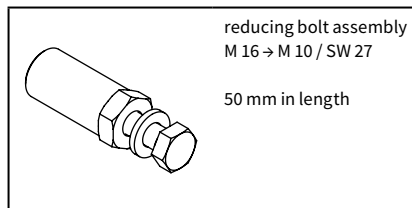

reducing bolt assembly
M 16 → M 10 / SW 27

50 mm in length

754921

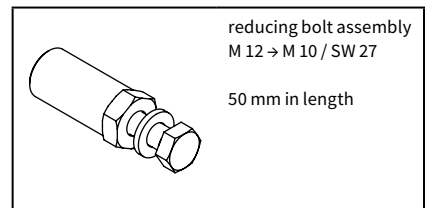

reducing bolt assembly
M 12 → M 10 / SW 27

50 mm in length

754911

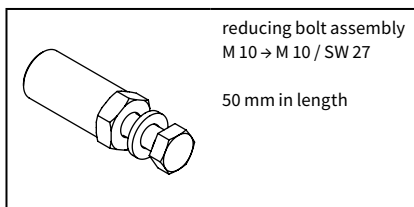

reducing bolt assembly
M 10 → M 10 / SW 27

50 mm in length

754901

. = insert RAL colour code no

01
02
03
04
05
06
07
08
09

10
11
12
13
14
15

Face fixture with spreader plate A

Pull-out force [N=Newton] per upper fixing point according to EN 13561, wind resistance class 2

compression-proof substrate
M [cm]

H [cm]	250	300	350	400	450	500	550	600	650	700
150	294	340	385	430	475	521	566	611	656	591
200	469	538	607	677	746	815	884	953	1023	927
250	—	764	862	960	1057	1155	1253	1350	1610	1454
300	—	—	1140	1271	1401	1532	1859	2008	2157	1944
350	—	—	—	1684	1852	2262	2455	2648	2422	2576
400	—	—	—	—	2577	2819	3062	3305	—	3210

non compression-proof substrate
M [cm]

H [cm]	250	300	350	400	450	500	550	600	650	700
150	418	483	547	611	675	740	804	868	932	840
200	666	765	863	961	1060	1158	1257	1355	1453	1317
250	—	1086	1225	1364	1502	1641	1780	1919	2288	2067
300	—	—	1620	1805	1991	2177	2641	2853	3065	2763
350	—	—	—	2393	2631	3214	3489	3763	3441	3661
400	—	—	—	—	3662	4007	4351	4696	—	4562

HT BHT	2 100 mm	2 100 mm 2 60 mm	2 100 mm 3 60 mm	3 100 mm 3 60 mm
BP	2	2	2	3
DP	—	2	3	3
BM	16	20	22	30

HT BHT	2 100 mm	2 100 mm 2 60 mm	2 100 mm 3 60 mm	3 100 mm 3 60 mm
BP	2	2	2	3
DP	—	2	3	3
BM	16	20	22	30

HT BHT	—	3 100 mm 3 60 mm
BP	—	3
DP	—	3
BM	—	30

HT BHT	—	3 100 mm 3 60 mm
BP	—	3
DP	—	3
BM	—	30

The pull-out force refers to the vertical centre to centre measurement between the fixing points of **76 mm**. In the case of spreader plates a washer conforming to DIN 9021 must be used.

- M** = awning width
- H** = projection
- FB** = pull-out force per fixing point
- HT | BHT** = bracket quantity | width
- BP** = no. of spreader plates
- DP** = no. of spacer plates
- BM** = no. of fixing points
- WA** = wall seal by way of aluminium + rubber sealing strip

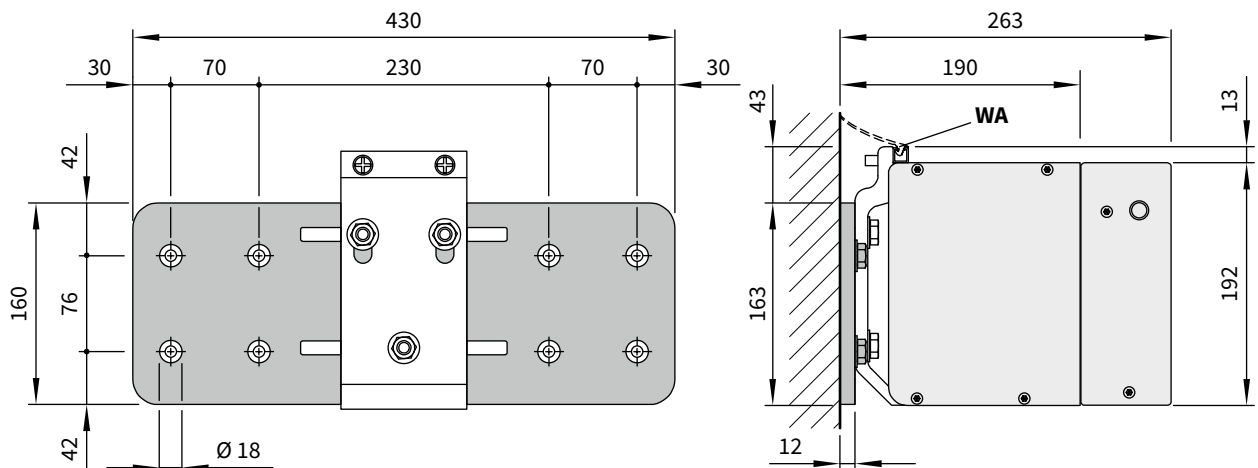

dimensions in mm

Face fixture with spreader plate B

Pull-out force [N=Newton] per upper fixing point according to EN 13561, wind resistance class 2

compression-proof substrate

M [cm]

250	300	350	400	450	500	550	600	650	700
-----	-----	-----	-----	-----	-----	-----	-----	-----	-----

H [cm]

FB [N]

150	174	201	228	255	281	308	335	362	388	350
200	277	318	359	400	441	482	523	564	605	549
250	—	452	510	568	626	683	741	799	857	861
300	—	—	675	752	829	907	1100	1188	1276	1151
350	—	—	—	996	1096	1339	1453	1567	1433	1524
400	—	—	—	—	1525	1668	1812	1956	—	1900

non compression-proof substrate

M [cm]

250	300	350	400	450	500	550	600	650	700
-----	-----	-----	-----	-----	-----	-----	-----	-----	-----

FB [N]

182	210	238	265	293	321	349	377	405	365
289	332	375	418	460	503	546	588	631	572
—	472	532	592	652	713	773	833	894	897
—	—	703	784	865	945	1147	1239	1331	1200
—	—	—	1039	1143	1396	1515	1634	1494	1590
—	—	—	—	1590	1740	1890	2039	—	1981

HT BHT	2 100 mm	2 100 mm 2 60 mm	2 100 mm 3 60 mm	3 100 mm 3 60 mm
BP	2	2	2	3
DP	—	2	3	3
BM	8	12	14	18

HT BHT	2 100 mm	2 100 mm 2 60 mm	2 100 mm 3 60 mm	3 100 mm 3 60 mm
BP	2	2	2	3
DP	—	2	3	3
BM	8	12	14	18

HT BHT	—	3 100 mm 1 60 mm
BP	—	3
DP	—	1
BM	—	14

HT BHT	—	3 100 mm 1 60 mm
BP	—	3
DP	—	1
BM	—	14

The pull-out force refers to the vertical centre to centre measurement between the fixing points of **350 mm**. In the case of spreader plates a washer conforming to DIN 9021 must be used.

M = awning width

H = projection

FB = pull-out force per fixing point

HT | BHT = bracket quantity | width

BP = no. of spreader plates

DP = no. of spacer plates

BM = no. of fixing points

WA = wall seal by way of aluminium + rubber sealing strip

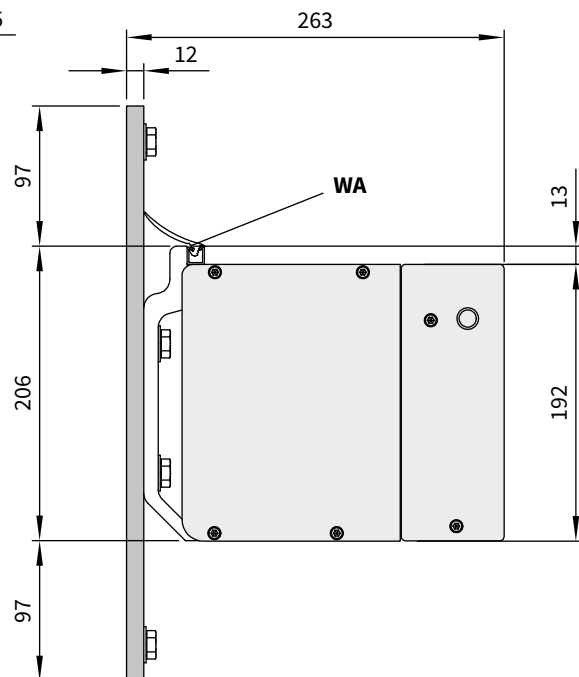
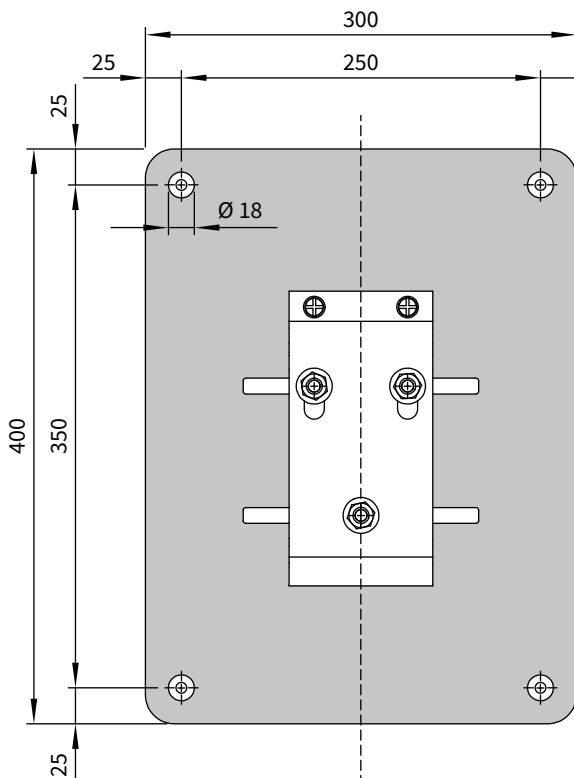

dimensions in mm

Face fixture with stand-off brackets

Pull-out force [N=Newton] per upper fixing point according to EN 13561, wind resistance class 2

compression-proof substrate
M [cm]

H [cm]	FB [N]									
	250	300	350	400	450	500	550	600	650	700
150	605	696	787	879	970	1061	1153	1244	1335	1206
200	919	1053	1187	1320	1454	1588	1722	1856	1990	1808
250	—	1448	1632	1815	1999	2183	2366	2550	3049	2758
300	—	—	2110	2350	2591	2831	3443	3718	3994	3604
350	—	—	—	3064	3368	4121	4472	4823	4414	4695
400	—	—	—	—	4633	5068	5503	5938	—	5772

non compression-proof substrate
M [cm]

H [cm]	FB [N]									
	250	300	350	400	450	500	550	600	650	700
150	680	783	886	989	1091	1194	1297	1400	1502	1357
200	1034	1184	1335	1486	1636	1787	1937	2088	2239	2034
250	—	1629	1836	2042	2249	2456	2662	2869	3430	3103
300	—	—	2373	2644	2914	3185	3874	4183	4493	4054
350	—	—	—	3447	3789	4636	5031	5426	4966	5282
400	—	—	—	—	5212	5701	6191	6680	—	6493

HT BHT	2 100 mm	2 100 mm 2 60 mm	2 100 mm 3 60 mm	3 100 mm 3 60 mm
DH 77968.	2	2	2	3
DH 77967.	—	2	3	3
BM	8	16	20	24

HT BHT	2 100 mm	2 100 mm 2 60 mm	2 100 mm 3 60 mm	3 100 mm 3 60 mm
DH 77968.	2	2	2	3
DH 77967.	—	2	3	3
BM	8	16	20	24

HT BHT	—	3 100 mm 1 60 mm
DH 77968.	—	3
DH 77967.	—	1
BM	—	16

HT BHT	—	3 100 mm 1 60 mm
DH 77968.	—	3
DH 77967.	—	1
BM	—	16

The pull-out force refers to the vertical centre to centre measurement between the fixing points of **120 mm**. In the case of stand-off brackets a washer conforming to DIN 9021 must be used.

M = awning width

H = projection

FB = pull-out force per fixing point

HT | BHT = bracket quantity | width

BM = no. of fixing points

DH = anzahl Distanzhalter

77967. = stand-off bracket for face fixture bracket 71995.

77968. = stand-off bracket for 2 pcs. face fixture bracket 71995.

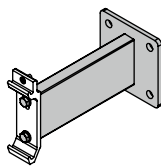

77967.

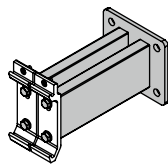

77968.

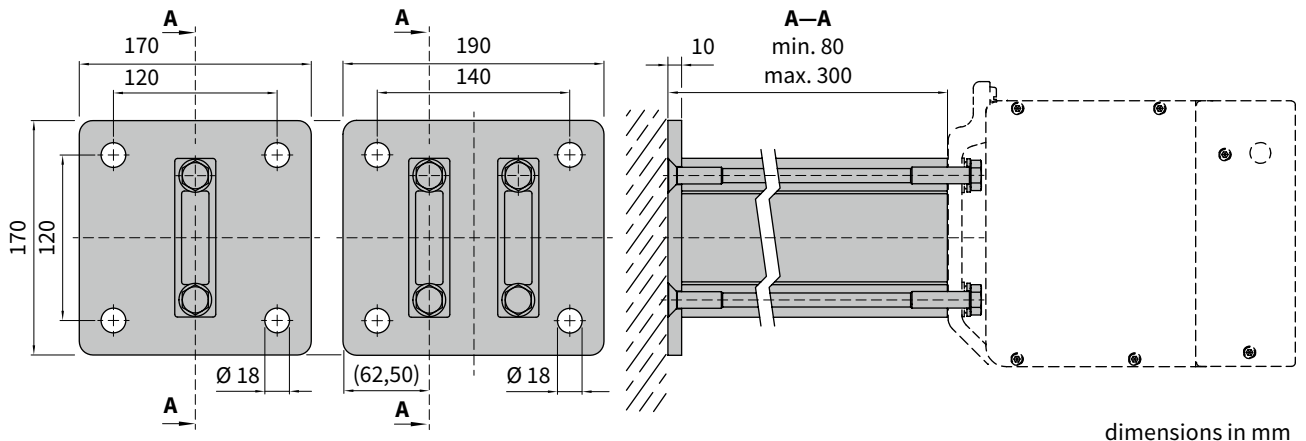

dimensions in mm

Top fixture

Pull-out force [N=Newton] per upper fixing point according to EN 13561, wind resistance class 2

compression-proof substrate

non compression-proof substrate

		M [cm]									
		250	300	350	400	450	500	550	600	650	700
H [cm]	FB [N]										
150		608	705	801	898	994	1091	1188	1284	1381	1271
200		934	1075	1217	1358	1500	1641	1782	1924	2065	1899
250		—	1498	1693	1887	2082	2277	2472	2666	3163	2884
300		—	—	2213	2470	2726	2983	3605	3895	4186	3802
350		—	—	—	3243	3569	4347	4720	5094	4683	4984
400		—	—	—	—	4926	5392	5858	6324	—	6172
HT BHT		2 90 mm		4 90 mm		5 90 mm		6 90 mm			
BM		8		16		20		24			
HT BHT		2 200 mm				—				3 200 mm 1 90 mm	
BM		12				—				22	

		M [cm]									
		250	300	350	400	450	500	550	600	650	700
H [cm]	FB [N]										
150		847	980	1114	1247	1380	1514	1647	1780	1914	1751
200		1315	1513	1711	1909	2106	2304	2502	2700	2898	2653
250		—	2046	2307	2569	2831	3093	3355	3617	4313	3895
300		—	—	3056	3406	3757	4108	4984	5384	5784	5214
350		—	—	—	4517	4969	6070	6588	7106	6498	6912
400		—	—	—	—	6919	7571	8223	8875	—	8621
HT BHT		2 90 mm		4 90 mm		5 90 mm		6 90 mm			
BM		8		16		20		24			
HT BHT		2 200 mm				—				3 200 mm 1 90 mm	
BM		12				—				22	

The pull-out force refers to the horizontal centre to centre measurement between the fixture points of **80 mm**.

- M** = awning width
- H** = projection
- FB** = pull-out force per fixing point
- HT | BHT** = bracket quantity | width
- BM** = no. of fixing points
- 71651.** = top fixture bracket assembly 90 mm
- 71652.** = top fixture bracket assembly 200 mm

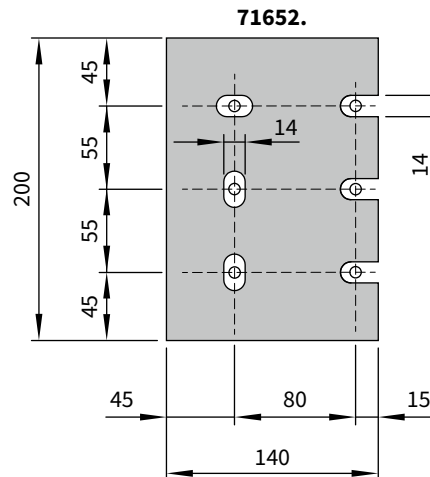
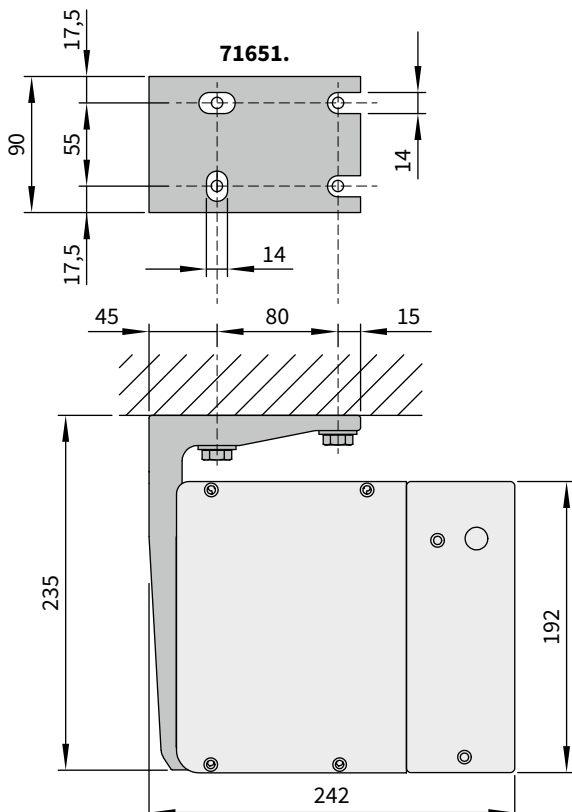

dimensions in mm

Eaves fixture

Torque [Nm = Newton metres] for the fixture bracket next to the arm, shear force [N = Newton] per fixing point according to EN 13561, wind resistance class 2

H [cm]	Torque M [cm]										Shear force M [cm]									
	250	300	350	400	450	500	550	600	650	700	250	300	350	400	450	500	550	600	650	700
	Md [Nm]										FS [N]									
150	126	145	164	184	203	222	242	261	280	252	1520	1760	1999	2239	2479	2719	2958	3198	3438	3152
200	200	230	260	289	319	349	378	408	438	397	2352	2706	3061	3415	3770	4124	4479	4833	5188	4756
250	—	327	369	411	453	495	537	579	690	623	—	3787	4277	4768	5259	5749	6240	6731	7992	7274
300	—	—	489	545	601	657	797	861	925	834	—	—	5607	6256	6904	7553	9136	9872	10608	9619
350	—	—	—	723	795	971	1054	1137	1040	1106	—	—	—	8231	9059	11040	11987	12934	11876	12639
400	—	—	—	—	1107	1211	1316	1420	—	1379	—	—	—	—	12526	13710	14893	16077	—	15676
HT	2		4		5		6				2		4		5		6			
BM	8		16		20		24				8		16		20		24			

The shear force is calculated on the basis of 2 fixing points per bracket, because – depending on the roof pitch – it cannot be guaranteed that 4 fixing points per bracket can be used.

- M** = awning width
- H** = projection
- Md** = torque value for the bracket in the immediate vicinity of the arm
- HT** = no. of brackets
- FS** = shear force
- BM** = no. of fixing points

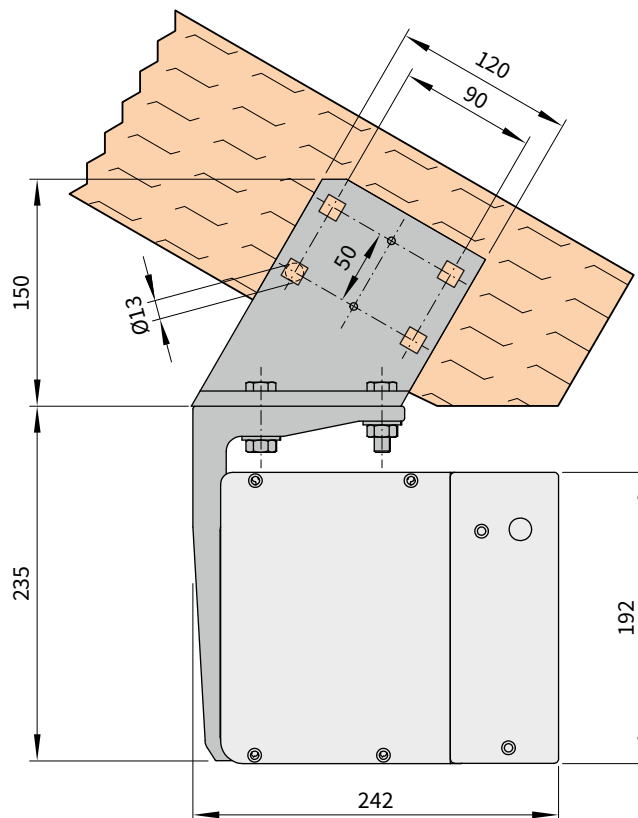

dimensions in mm

01 **Eaves fixture with additional spreader / backing plate**

02 Torque [Nm = Newton metres] for the fixture bracket next to the arm, shear force [N = Newton] per fixing point according to EN 13561, wind resistance class 2

03

04

05

06

07

08

09

H [cm]	Torque M [cm]										Shear force M [cm]									
	250	300	350	400	450	500	550	600	650	700	250	300	350	400	450	500	550	600	650	700
	Md [Nm]										FS [N]									
150	126	145	164	184	203	222	242	261	280	252	753	874	996	1118	1239	1361	1483	1604	1726	1611
200	200	230	260	289	319	349	378	408	438	397	1127	1300	1474	1647	1820	1993	2167	2340	2513	2333
250	—	327	369	411	453	495	537	579	623	623	—	1786	2021	2256	2490	2725	2959	3194	3429	3466
300	—	—	489	545	601	657	713	769	825	834	—	—	2620	2925	3231	3536	3842	4147	4452	4521
350	—	—	—	723	795	867	939	1011	1083	1106	—	—	—	3814	4200	4586	4972	5358	5744	5880
400	—	—	—	—	1107	1211	1316	1420	—	1379	—	—	—	—	5760	6307	6853	7400	—	7247
HT	2				4		5		6		2				4		5		6	
BM	4				8		10		12		4				16		20		12	

By using the additional spreader / backing plate, the shear force is reduced in comparison with conventional eaves fixture.

10

- 11 **M** = awning width
- 12 **H** = projection
- 13 **Md** = torque value for the bracket in the immediate vicinity of the arm
- 14 **HT** = no. of brackets
- 15 **FS** = shear force
- BM** = no. of fixing points

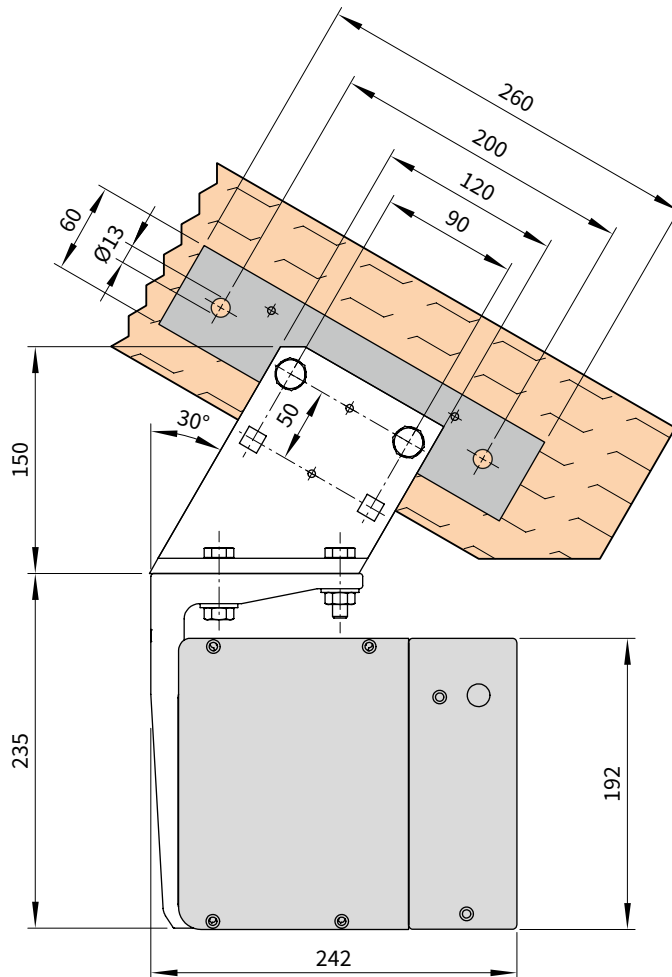

dimensions in mm

Recess fixture

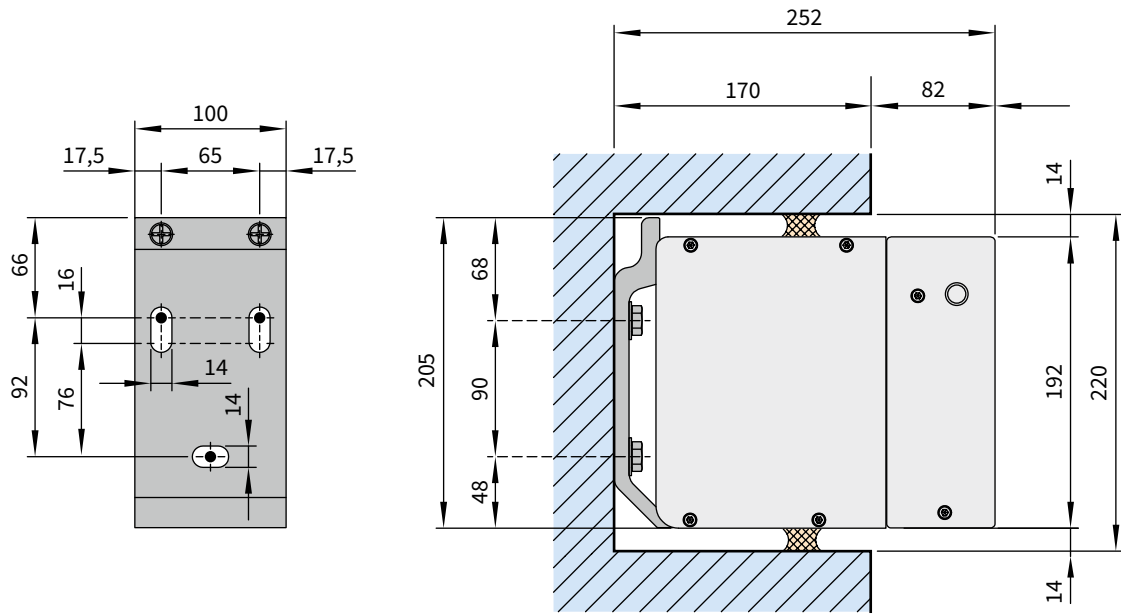

- 01
- 02
- 03
- 04
- 05
- 06
- 07
- 08
- 09
- 10**
- 11
- 12
- 13
- 14
- 15

dimensions in mm

Cable exit position on motor-driven units

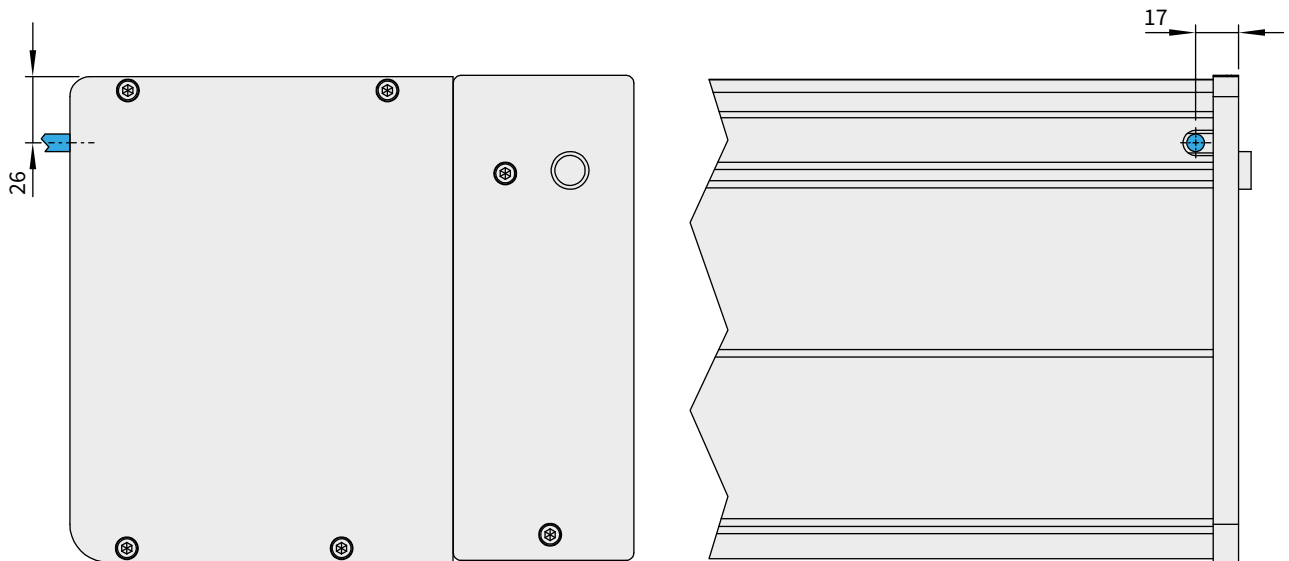

dimensions in mm

01 **Overview of the dimensions** (using face fixture with manual operation by way of example)

02

03

04

05

06

07

08

09

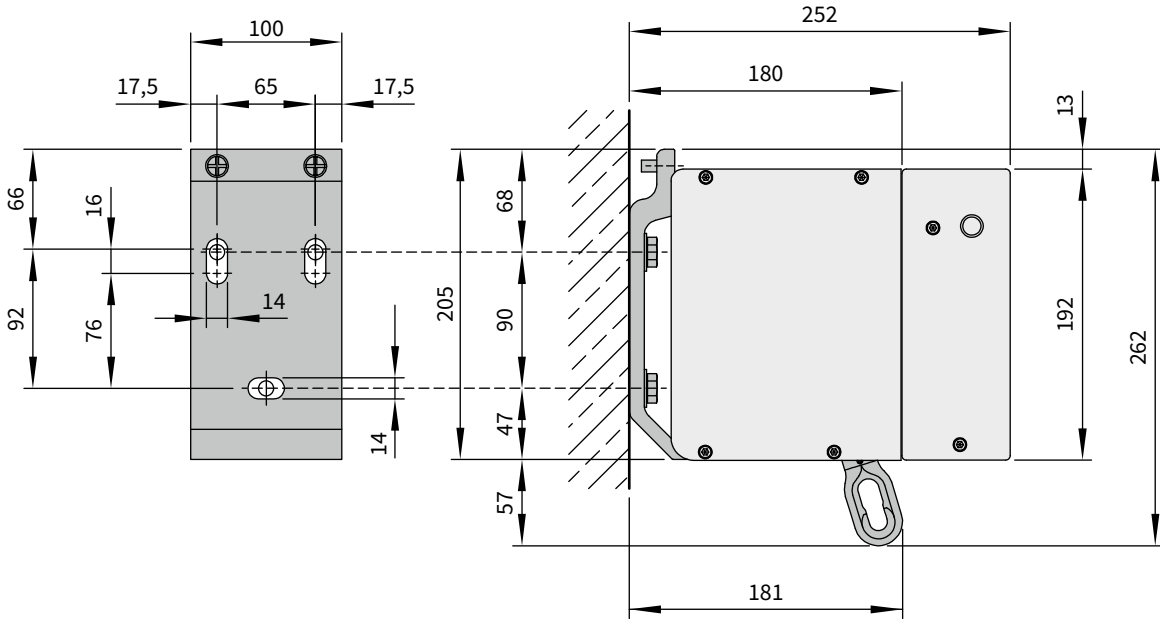

dimensions in mm

10

11

12

13

14 **Front view**

15

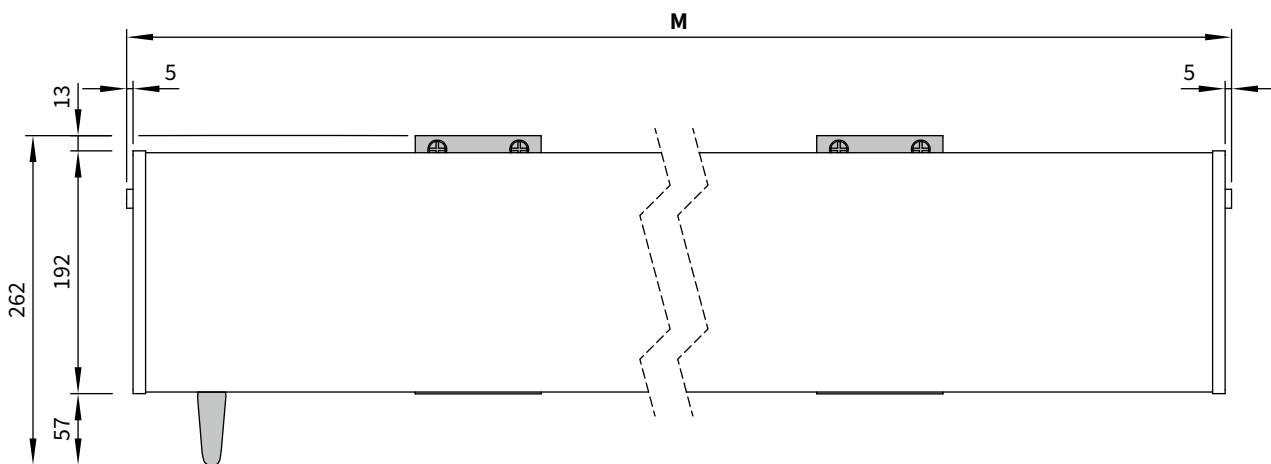

M = awning width

dimensions in mm

Bracket fixture range for awnings with 2 folding arms

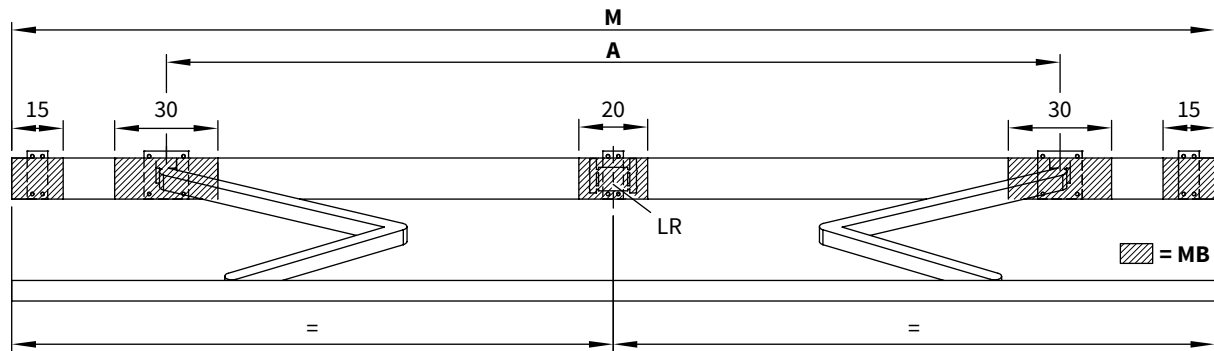

dimensions in cm

M [cm]	SB →	250	300	350	400	450	500	550	600	650
	ZB →		190–250	251–300	301–350	351–400	401–450	451–500	501–550	551–600

H [cm] ↓	A [cm]								
150	168**	230	260	300	340	380	410	450	490
200	205*	218**	260	300	340	380	410	450	490
250	—	255*	268**	300	340	380	410	450	490
300	—	—	305*	318**	340	380	410	450	490
350	—	—	—	355*	368**	380	440	450	—
400	—	—	—	—	405*	418**	440	450	—

dimensions in cm

W	BHT ↓	HT ↓		
	60 mm	—	—	2
100 mm	2	—	2	2
200 mm	—	2	—	—

W A/B	60 mm	—	—	2	3
	100 mm	2	2	2	2

DE / DA	90 mm	2	—	4	5
	200 mm	—	2	—	—

If the brackets cannot be positioned in accordance with this table, make sure the actual measurements are noted on the order form!

* = Please note the minimum widths! Dimension **A** is only valid for standard arms!

Coupled units are not available with junction roller.

** = Please note the minimum widths! Dimension **A** is only valid for standard arms! Dimension **A** is 13 cm smaller in the case of bespoke arms. Coupled units are only available with junction roller in the standard widths, in the case of other widths please ask us.

A = arm position

BHT = bracket width

DA = eaves fixture

DE = eop fixture

H = projection

HT = no. of brackets

LR = a rolltex bearing with accompanying bracket is always placed under a central seam

M = awning width

MB = bracket fixture range

SB = standard width

W = face fixture

W A/B = face fixture with spreader plate A/B

ZB = intermediate width

Bracket fixture range for awnings with 3 folding arms

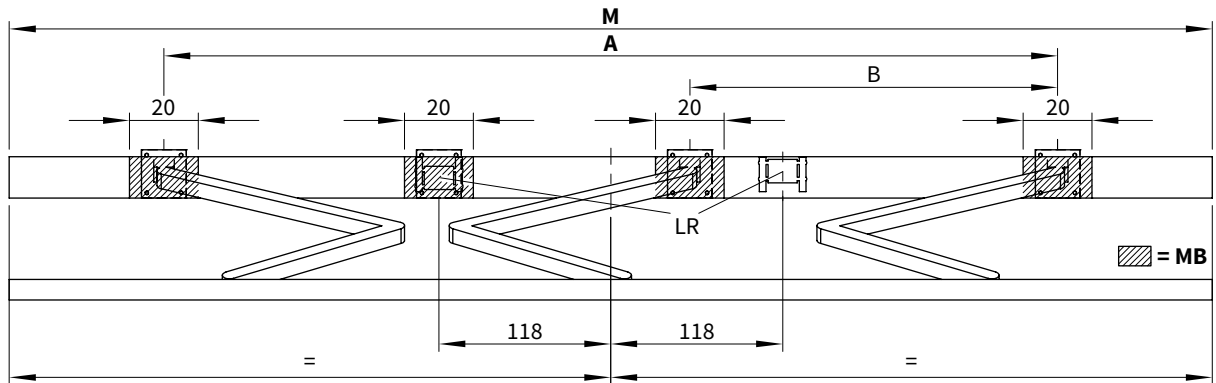

dimensions in cm

M [cm]	SB →	650	700		
	ZB →	—	651—700	651—689	700

H [cm] ↓	A [cm] ↓	B [cm] ↓	A [cm] ↓	B [cm] ↓	A [cm] ↓	B [cm] ↓	A [cm] ↓	B [cm] ↓
150	—	—	540	250	—	—	—	—
200	—	—	540	250	—	—	—	—
250	—	—	550	235	—	—	—	—
300	—	—	580	235	—	—	—	—
350	615	230	—	—	615	230	640	230
400	—	—	—	—	—	—	665	235

dimensions in cm

W	BHT ↓	HT ↓	HT ↓
	60 mm	1	3
	100 mm	—	3
	200 mm	3	—

W A/B	60 mm	1	3
	100 mm	3	3

DE / DA	90 mm	1	6
	200 mm	3	—

If the brackets cannot be positioned in accordance with this table, make sure the actual measurements are noted on the order form!

* = coupled units are not available with junction roller

A = arm position

BHT = bracket width

DA = eaves fixture

DE = top fixture

H = projection

HT = no. of brackets

LR = a rolltex bearing with accompanying bracket is always placed under a central seam

M = awning width

MB = bracket fixture range

SB = standard width

W = face fixture

W A/B = face fixture with spreader plate A/B

ZB = intermediate width