



FRONT ENTRANCE DOORS RD65



109



RYTERNA Front Entrance Doors

Entrance door is a key element of house façade. Every day You see, touch and use it. Door must be safe, warm, maintenance free and match the exterior.

We offer wide range of made to measure and standard size doors with numerous design choices including possibility to create Your own design. Latest technologies combined with perfect design results outstanding appearance and performance.

Certificated according to security and burglary Resistance Class RC2*



* For doors without windows

Entrance door RD65

- 1 - Polyurethane foam
- 2 - Cold rolled steel
- 3 - Hot dip galvanisation
- 4 - Chemical treatment
- 5 - Powder coated

U-value up to
0.73 W/m²K

Specifications

RD65 Frame is made of composite aluminium profiles with 24 mm thick thermal break. Leaf is 65 mm thick with steel sheet skin. Thermal insulation - freon free PU foam.

Door Seals

Door has 3 seal contours: 1 on the frame and 2 on the leaf. Three contour sealing ensures perfect insulation.

Door Hinges

Door comes with three Schuring hinges adjustable in three directions for easy adjustment and perfect operation.

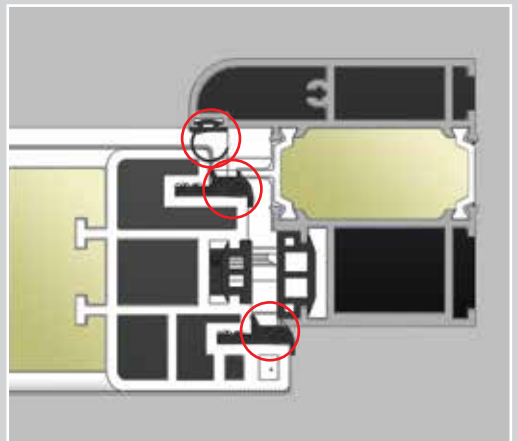
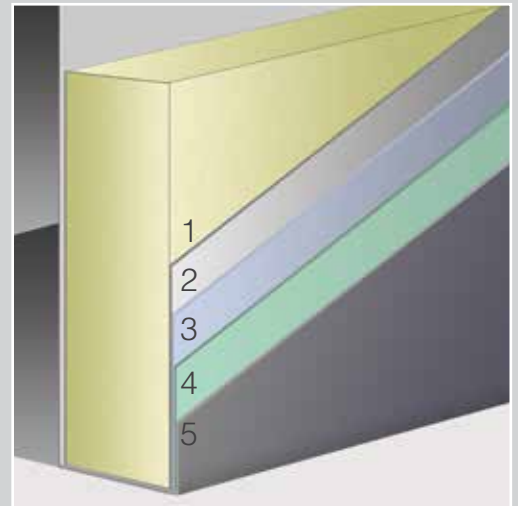

Threshold

Durable aluminium and PVC composite threshold profile.



Dimensions

Threshold height is 12 mm on the inside and 22.5 mm on the outside.

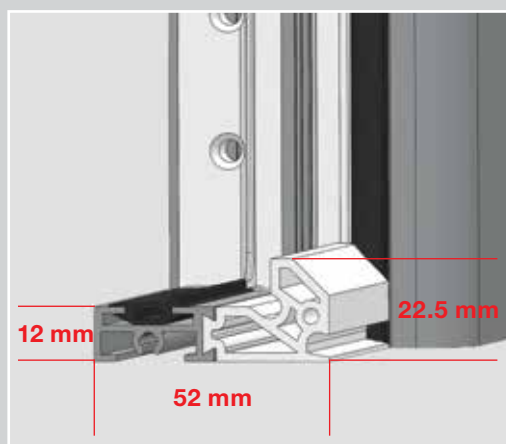

Add-on profiles

Add on bottom profiles. 15 mm and 30 mm height. Can be combined in series..
15mm+30mm+30mm.....

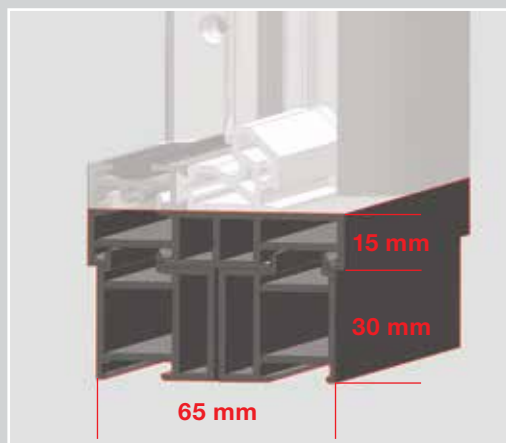

Colours

Outside RAL colours 7016 and 9016 come as a standard. Inside colour is RAL 9016. Door Outside could be painted any RAL colour upon request.





Design No. 101

Brushed Aluminium Decor

Durable aluminium appliqué will make Your door special.
Small highlight can dramatically change Your house curb appeal.



Draw your own Design



100



You can draw Your own design including windows and appliques. Consult manufacturer for feasibility and price.

 Please note that colours depicted for guidance only. Please use official printed materials for accurate colour.

Available brushed aluminium decor standard designs



101



102



103



104



105

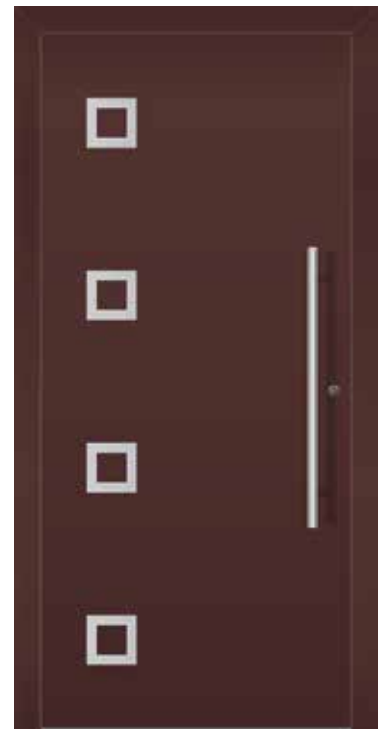

106



Please note that colours depicted for guidance only.
Please use official printed materials for accurate colour.

Available brushed aluminium decor and windows standard designs

Appliques combined with windows make Your door look distinctively.

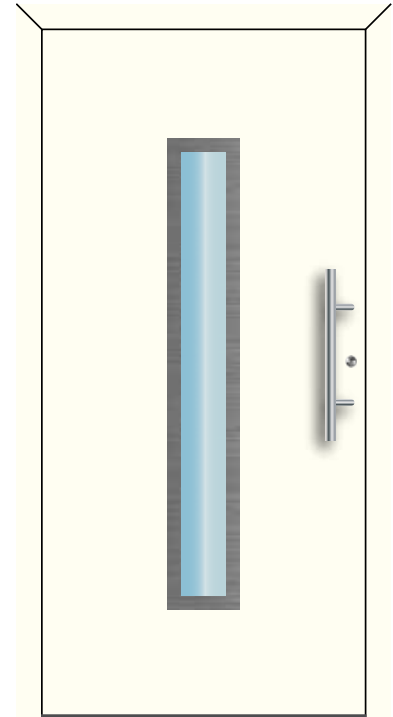

108

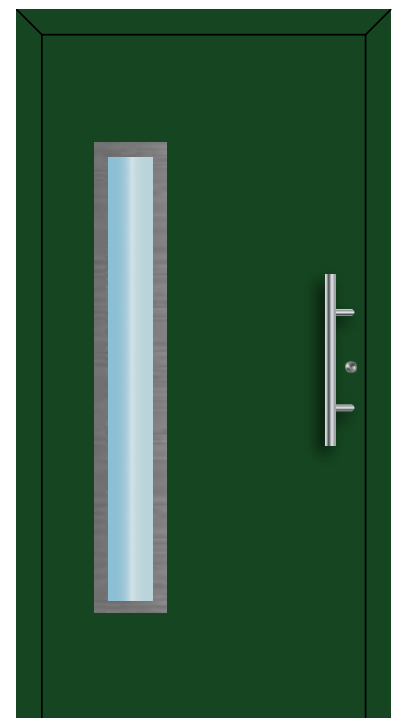

112



Please note that colours depicted for guidance only.
Please use official printed materials for accurate colour.

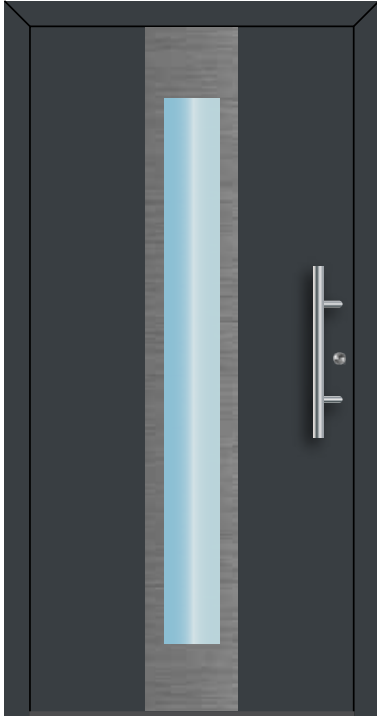

109

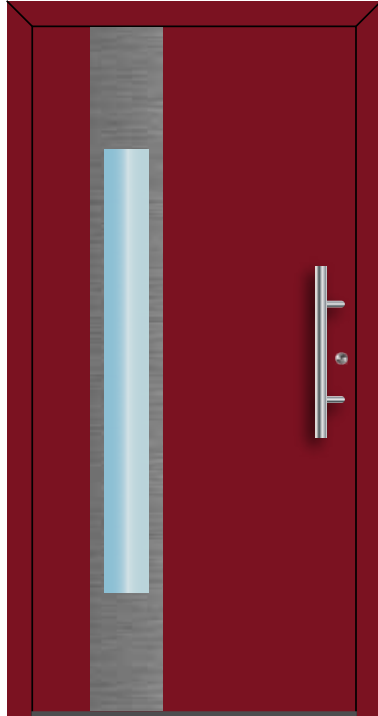

110



111

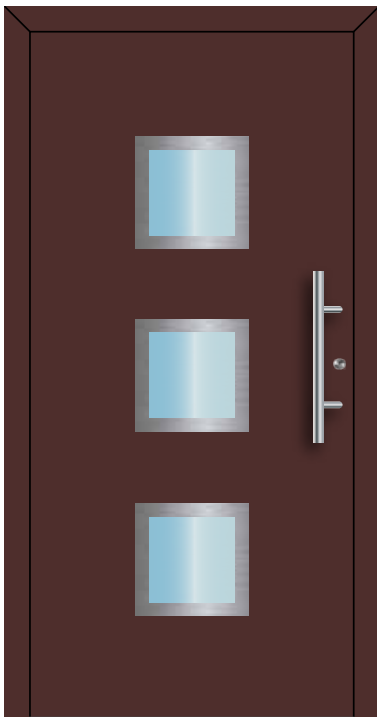

113

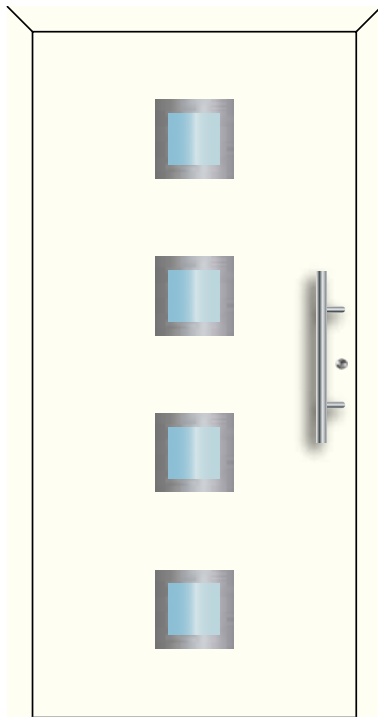

114

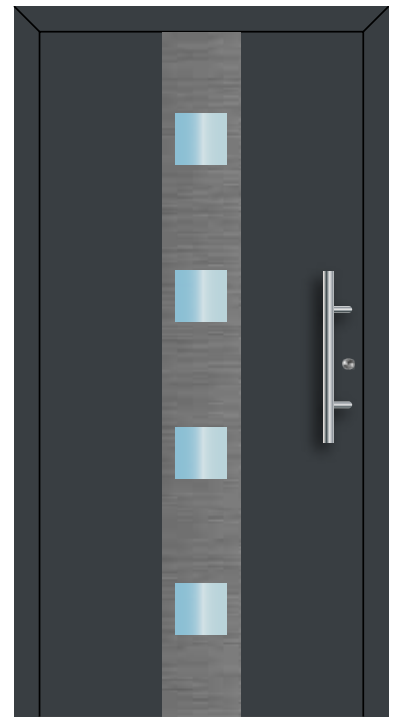

115

 Please note that colours depicted for guidance only. Please use official printed materials for accurate colour.



Design No. 109

Give your home extra sunlight

Made to measure side elements with triple safety glazing will let more sunlight in to Your home. Choose one of available glazing options: clear, matt and tinted. Custom design available on request.

Side and top elements

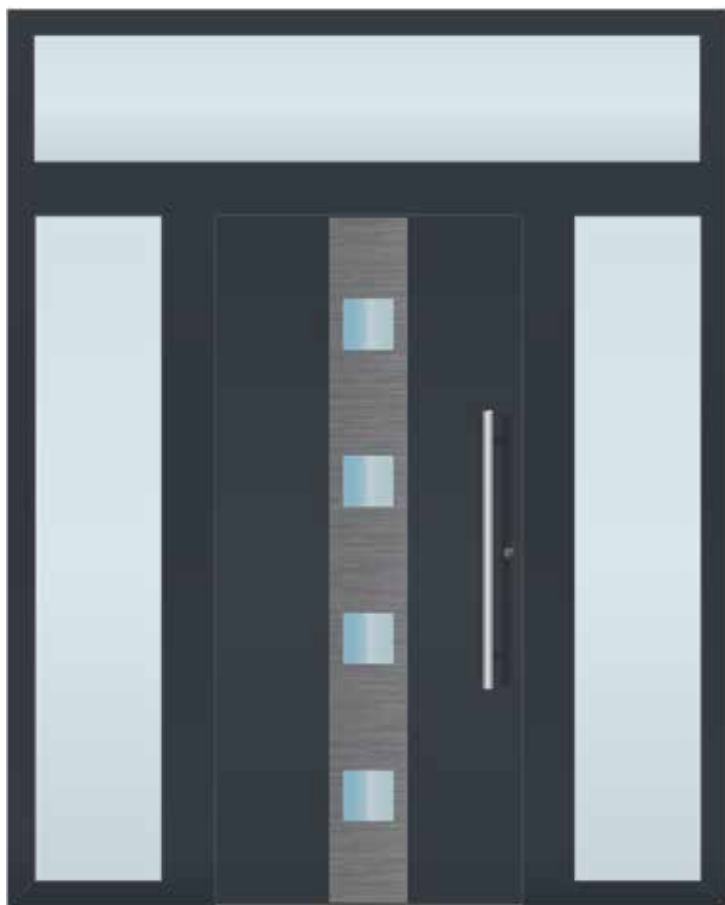

Glazing options:



Clear **SGC**



Tinted **SGT**



Matt **SGM**

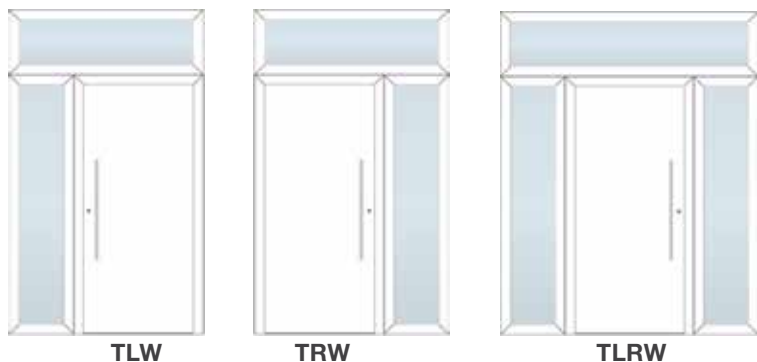
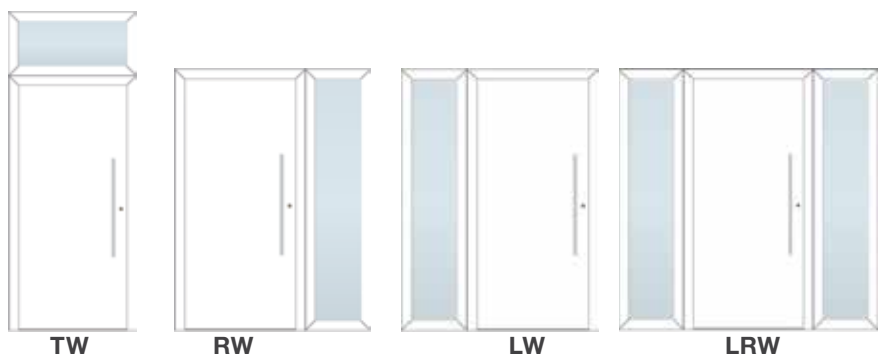

Hinges



Key cylinders (safety classes A,B,C)



Locks



3 points multiple lock **L3P**

5 points multiple lock **L5P**

Day & Night **L3P+D&N**

3 points multiple lock with option to switch off self-locking during daytime

Electric 1 **L3P+D&N+EM**

3 points multiple lock with electric strike and option to switch off self-locking during daytime.

Lock can be connected to finger-scan or keypad (optional)

Electric 2 **L5PMA**

5 points multiple lock, latch-bolts are self mechanically locking and opening by electric drive, dead-bolt operated by key.

Lock can be connected to finger-scan or keypad (optional)

Electric 3 **L5PA**

5 points multiple lock, Latch-bolts and dead-bolts are operated by electric drive.

Lock can be connected to finger-scan or keypad (optional)



L3P



L5P

Escutcheons



ESC-1

ESC-2

Finger scanners, keypads and remote handset available



FSC1

FSC2

FSC3

FSC4

KP1

KP2

KP3

RMT1

Stainless steel handles



H45R-500
Ø 30 mm
H 500 mm
45°

H45R-800
Ø 30 mm
H 800 mm
45°



H45S-500
30x20 mm
H 500 mm
45°

H45S-800
30x20 mm
H 800 mm
45°

Lever handles / Knob handles



HL-W (White)



HL-B (Black)



***HK-W** (White)



***HK-B** (Black)



HLA



HLS 01



HLS 02



HLS 03



HLS 04



HLS 05



HLS 06