

# GARAGE DOOR

PRICE LIST FEBRUARY 2018



**WESSEX**  
**DOORS**

Includes Auto Over Insulated Roller Garage Doors





## COMPOSITE GARAGE DOORS

Wessex Doors is Europe's largest manufacturer of low maintenance Composite garage doors and a leading innovator in the field of garage door design.

Based in Verwood, Dorset, with its head office at Blackrod, Bolton, Wessex Doors manufactures a range of hand built and finished doors in strong durable Composite with either luxury Gloss White or faithfully reproduced Woodgrain finishes..

### Welcome to the Wessex Garage Doors Price List

Composite G.R.P. is an incredibly strong, dent resistant modern laminate with a better strength to weight ratio than steel. The door face is devoid of joints, seams, rivets or fastenings to detract from its good looks. All doors are supplied fully finished, won't warp, shrink or rust and are virtually maintenance free. Up and over and side hinged doors are built onto a strong, corrosion protected steel chassis that provides a protective "picture frame" edge all around the door panel.



#### Contents:







COMPOSITE UP AND OVER GARAGE DOORS	3 - 5
UP & OVER DOOR OPTIONS	6
UP & OVER DOOR GENERAL INFORMATION	7
AUTOMATION	7
COMPOSITE SIDE HINGED GARAGE DOORS	8 - 9
INSULATED ROLLER GARAGE DOORS	10
TECHNICAL DETAILS	11 - 14
WARRANTY	16

#### PRICES & NOTES

All Prices are in £ Sterling and exclude VAT & delivery.

Illustrations in this brochure are intended as a guide only to product styles and profiles. Handle positions will vary dependent upon the style, operation and size of the door. Side and top stiles (the area around a particular design) may vary in width and height dependent upon the size, even on doors of the same style.

#### Key to symbols

Standard Sizes only	
Made to Measure available	
Security Multi-Point Locking	
Glazing Options available – see page 6 for pricing	
Frames available – see page 6 for pricing	
Doors available over 2134mm (7'0") high	

#### DELIVERY CHARGES



All doors

Delivery charges any quantity of door: **£55.00 NET**

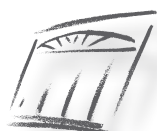
Mainland England, Scotland and Wales only. Northern Ireland, Channel Islands, Isle of Man, and export delivery – charges on application. Delivery charges and VAT to be added to all prices.

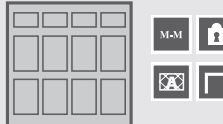

# ONE PIECE UP & OVER GARAGE DOORS

COMPOSITE GLOSS WHITE																
	DORIC		DORIC		GEORGIAN		GEORGIAN		HAMBLE		HAMBLE		WIMBORNE		WIMBORNE	
	CANOPY	RETRACTABLE	CANOPY	RETRACTABLE	CANOPY	RETRACTABLE	CANOPY	RETRACTABLE	CANOPY	RETRACTABLE	CANOPY	RETRACTABLE	CANOPY	RETRACTABLE	CANOPY	RETRACTABLE
STANDARD (WXH)	3	4	3	4	3	4	3	4	3	4	3	4	3	4	3	4
2084 x 1931/1981/2134 (6'10" x 6'4"/6'6"/7'0")					1203	1333	1253	1383					1390	1520	1440	1650
2134 x 1931/1981/2134 (7'0" x 6'4"/6'6"/7'0")	*1039	*1169	*1089	*1219	1203	1333	1253	1383	1203	1333	1253	1383	1390	1520	1440	1650
2259 x 1981/2134 (7'5" x 6'6"/7'0")					1243	1373	1293	1423	1300	1430	1350	1480	1528	1658	1578	1788
2284 x 1981/2134 (7'6" x 6'6"/7'0")					1243	1373	1293	1423	1459	1589	1509	1639	1528	1658	1578	1788
2439 x 1931/1981/2134 (8'0" x 6'4"/6'6"/7'0")					1328	1458	1378	1508					1568	1698	1618	1828
4269 x 1981/2134 14'0" x 6'6"/7'0"							1324	1454			2242	2452			2563	2773
SPECIAL SIZES WIDTH	MADE TO MEASURE SIZES IN 5MM INCREMENTS															
1981mm (6'6")					1288	1418	1338	1468					1488	1618	1538	1668
2134mm (7'0")					1288	1418	1338	1468					1488	1618	1538	1668
2286mm (7'6")					1320	1450	1370	1500					1635	1765	1685	1815
2438mm (8'0")					1418	1548	1468	1598					1692	1822	1742	1872
2743mm (9'0")																
3048mm (10'0")																
3353mm (11'0")																
3658mm (12'0")																
3962mm (13'0")																
4267mm (14'0")							2485	2695							2743	2953
4572mm (15'0")							2946	3156							3197	3407
4877mm (16'0")																
	SS widths: 7'0" SS heights: 6'6" or 7'0"				MtoM widths: 6'0" to 8'0" & 14'0" to 15'0" MtoM heights: 6'3" to 7'0"				SS widths: 7'0", 7'5", 7'6", 14'0" SS heights: 6'6" or 7'0"				MtoM widths: 6'0" to 8'0" & 14'0" to 15'0" MtoM heights: 6'4" to 7'0"			
	SS widths (mm): 2134 SS heights (mm): 1981 or 2134				MtoM widths (mm): 1828 to 2438 & 4269mm to 4572mm MtoM heights (mm): 1905 to 2134				SS widths (mm): 2134, 2259, 2284, 4269 SS heights (mm): 1981 or 2134				MtoM widths (mm): 1828 to 2438 & 4269 to 4572 MtoM heights (mm): 1931 to 2134			

**NOTES:**

Canopy doors and doors 10'0" (3048mm) wide and over are available in a maximum height of 7'0" (2134mm)  
 \* Available in 7'0" x 6'6" and 7'0" x 7'0" only. 7'0" x 6'6" retractable - only suitable for automation due to handle position.  
 On double doors the design will equate to 2 single doors side by side.



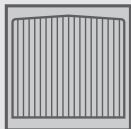
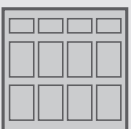
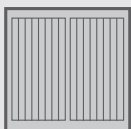
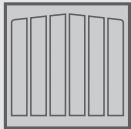

# ONE PIECE UP & OVER GARAGE DOORS

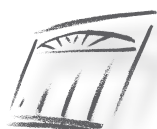
COMPOSITE WOODGRAIN	 <b>AVONBROOK</b>				 <b>CANTERBURY (WIDE GRAIN)</b>				 <b>FRENSHAM (WIDE GRAIN)</b>				 <b>PEMBROKE (WIDE GRAIN)</b>			
	CANOPY		RETRACTABLE		CANOPY		RETRACTABLE		CANOPY		RETRACTABLE		CANOPY		RETRACTABLE	
	3	4	3	4	3	4	3	4	3	4	3	4	3	4	3	4
<b>STANDARD (WXH)</b>																
2084 x 1931/ 1981/ 2134 (6'10" x 6'4" / 6'6" / 7'0")	1362	1492	1412	1622	1362	1492	1412	1622	1362	1492	1412	1622	1362	1492	1412	1622
2134 x 1931/1981/2134 (7'0" x 6'4" / 6'6" / 7'0")	1362	1492	1412	1622	1362	1492	1412	1622	1362	1492	1412	1622	1362	1492	1412	1622
2259 x 1981/2134 (7'5" x 6'6" / 7'0")	1568	1698	1618	1828	1568	1698	1618	1828	1568	1698	1618	1828	1568	1698	1618	1828
2284 x 1981/2134 (7'6" x 6'6" / 7'0")	1568	1698	1618	1828	1568	1698	1618	1828	1568	1698	1618	1828	1568	1698	1618	1828
2439 x 1931/1981/2134 (8'0" x 6'4" / 6'6" / 7'0")	1643	1773	1693	1903	1693	1823	1743	1953	1643	1773	1693	1903	1643	1773	1693	1903
4269 x 1981/2134 14'0" x 6'6" / 7'0"			2670	2880			2670	2880			2670	2880			2670	2880
<b>SPECIAL SIZES WIDTH</b>																
<b>MADE TO MEASURE SIZES IN 5MM INCREMENTS</b>																
1981mm (6'6")	1458	1588	1508	1638	1458	1588	1508	1638								
2134mm (7'0")	1458	1588	1508	1638	1458	1588	1508	1638	1458	1588	1508	1638	1458	1588	1508	1638
2286mm (7'6")	1678	1808	1728	1858	1678	1808	1728	1858	1678	1808	1728	1858	1678	1808	1728	1858
2438mm (8'0")	1733	1863	1783	1913	1733	1863	1783	1913	1733	1863	1783	1913	1733	1863	1783	1913
2743mm (9'0")							2053	2183							2053	2183
3048mm (10'0")							2233	2363							2233	2363
3353mm (11'0")							2448	2658							2448	2658
3658mm (12'0")							2735	2945							2735	2945
3962mm (13'0")							2830	3040							2830	3040
4267mm (14'0")			2857	3067			2857	3067			2802	3012			2857	3067
4572mm (15'0")			3270	3480			3270	3480			3270	3480			3270	3480
4877mm (16'0")			3596	3806			3596	3806							3596	3806
	MtoM widths: 6'7" to 8'0" & 14'0" to 16'0" MtoM heights: 6'6" to 7'0"				MtoM widths: 6'0" to 16'0" MtoM heights: 6'4" to 7'0"				MtoM widths: 6'9"/4" to 8'0" & 14'0" to 15'0" MtoM heights: 6'4" to 6'7" & 6'8"/4" to 7'0"				MtoM widths: 7'0" to 15'6" MtoM heights: 6'4"/4" to 7'0"			
	MtoM widths (mm): 2006 to 2438 & 4269 to 4879 MtoM heights (mm): 1981 to 2134				MtoM widths (mm): 1828 to 4724 MtoM heights (mm): 1931 to 2134				MtoM widths (mm): 2076 to 2439 & 4269 to 4572 MtoM heights (mm): 1931 to 2006 & 2050 to 2134				MtoM widths (mm): 2134 to 3498 MtoM heights (mm): 1949 to 2134			

**NOTES:**  
Canopy doors and doors 10'0" (3048mm) wide and over are available in a maximum height of 7'0" (2134mm)  
On double doors the design will equate to 2 single doors side by side.



# ONE PIECE UP & OVER GARAGE DOORS



COMPOSITE WOODGRAIN																
	RIPON		SHERWOOD (WIDE GRAIN)		YORK		LYMINGTON (WITH WINDOWS)									
	CANOPY	RETRACTABLE	CANOPY	RETRACTABLE	CANOPY	RETRACTABLE	CANOPY	RETRACTABLE								
STANDARD (WXH)	3' 4'	3' 4'	3' 4'	3' 4'	3' 4'	3' 4'	3' 4'	3' 4'								
2084 x 1931/1981/2134 (6'10" x 6'4"/6'6"/7'0")	1362	1492	1412	1622			1362	1492	1412	1622						
2134 x 1931/1981/2134 (7'0" x 6'4"/6'6"/7'0")	1362	1492	1412	1622	1607	1737	1657	1867	1362	1492	1412	1622	1410	1540	1460	1670
2259 x 1981/2134 (7'x5"x6'6"/7'0")	1568	1698	1618	1828	1655	1785	1705	1915	1568	1698	1618	1828	1480	1610	1530	1740
2284 x 1981/2134 (7'6"x6'6"/7'0")	1568	1698	1618	1828	1655	1785	1705	1915	1568	1698	1618	1828	1480	1610	1530	1740
2439 x 1931/1981/2134 (8'0" x 6'4"/6'6"/7'0")	1643	1773	1693	1903	1735	1865	1785	1995	1643	1773	1693	1903	1520	1650	1570	1780
4269 x 1981/2134 14'0" x 6'6"/7'0"			2670	2880			2704	2914			2670	2880				
SPECIAL SIZES WIDTH																
MADE TO MEASURE SIZES IN 5MM INCREMENTS																
1981mm (6'6")																
2134mm (7'0")	1458	1588	1508	1638	1720	1850	1770	1900	1458	1588	1508	1638	1490	1620	1540	1670
2286mm (7'6")	1678	1808	1728	1858	1771	1901	1821	1951	1678	1808	1728	1858	1560	1690	1610	1740
2438mm (8'0")	1733	1863	1783	1913	1825	1955	1875	2005	1733	1863	1783	1913	1610	1740	1660	1790
2743mm (9'0")			2053	2183							2053	2183				
3048mm (10'0")			2233	2363							2233	2363				
3353mm (11'0")			2448	2658							2448	2658				
3658mm (12'0")			2735	2945							2735	2945				
3962mm (13'0")			2830	3040							2830	3040				
4267mm (14'0")			2857	3067			3183	3393			2857	3067				
4572mm (15'0")			3270	3480			3249	3459			3270	3480				
4877mm (16'0")			3596	3806			3568	3778			3596	3806				
	MtoM widths: 6'0" to 15'0" MtoM heights: 6'4" to 7'6"				MtoM widths: 7'0" to *8'0" & *14'0" to 16'0" MtoM heights: 6'5 1/4" to 7'0"				MtoM widths: 6'0" to 16'0" **MtoM heights: 6'4" to 8'0"				MtoM widths: 6'11" to 8'0" MtoM heights: 6'4" to 7'6"			
	MtoM widths (mm): 1930 to 4572 MtoM heights (mm): 1920 to 2286				MtoM widths (mm): 2134 to *2438 & *4267 to 4877 MtoM heights (mm): 1975 to 2134				MtoM widths (mm): 1830 to 4877 **MtoM heights (mm): 1931 to 2438				MtoM widths (mm): 2109 to 2438 MtoM heights (mm): 1920 to 2286			

**NOTES:**

Canopy doors and doors 10'0" (3048mm) wide and over are available in a maximum height of 7'0" (2134mm)  
On double doors the design will equate to 2 single doors side by side.

## OPTIONS & AUTOMATION

### WINDOWS\*, LOCKS, COLOURS, LIFTING GEAR, DRAUGHT STRIPS AND BRACKETS

Black windows on single doors up to 2438mm (8'0") wide (please specify leading requirements)		160 per door
Black windows on double doors over 2438mm (8'0") wide (please specify leading requirements)		320 per door
Clear or Stippled windows on single doors up to 2438mm (8'0") (please specify leading requirements)		328 per door
Clear or Stippled windows on double doors over 2438mm (8'0") (please specify leading requirements)		655 per door
Clear or Stippled windows on single doors up to 2438mm (8'0") (please specify leading requirements)		360 per door
Clear or Stippled windows on double doors over 2438mm (8'0") (please specify leading requirements)		720 per door
Clear or Stippled windows on single doors up to 2438mm (8'0") (please specify leading requirements)		430 per door
Clear or Stippled windows on double doors over 2438mm (8'0") (please specify leading requirements)		860 per door
Colour Option available for Woodgrain doors only – blue, green and red for single doors up to 2438mm (8'0") wide		300 per door
Colour Option available for Woodgrain doors only – blue, green and red for double doors over 2438mm (8'0") wide		395 per door
Coastal colour options available for Woodgrain doors only –		
Beaumont Blue, Bluebell Blue, Seagrass Green, County Cream and Charleston Grey for single doors up to 2438mm (8'0") wide		300 per door
Beaumont Blue, Bluebell Blue, Seagrass Green, County Cream and Charleston Grey for single doors over 2438mm (8'0") wide		395 per door
Special RAL colours		P.O.A
Chrome effect finish handle (upgrade from black)		45 per set
Additional lock kit Canopy / Retractable type (single sizes)		50
Bottom edge strip (bottom edge brush strip helps prevent dirt and draughts blowing into your garage) single/double doors		42 (8' lengths)
Retractable Plus lifting gear - 6'0", 6'6" and 7'0" high doors only		35

\*Please note: Diagonal bracings will be visible on double doors

## FRAMES

### Steel Frames

#### Canopy Doors

Suitable for all single doors up to 2438mm x 2134mm (8'0" x 7'0"). Frames are pre-fitted to the door. Standard frame jambs are 60mm wide and the frame head is 60mm high. Minimum door height 1930mm (6'4").

#### Single Retractable Doors

Suitable for all single doors up to . Frames are pre-fitted to the door. Jambs are 75mm wide and the head is 60mm (2.2/3") high. Minimum door height 1930mm (6'4").

#### Double Retractable Doors

Suitable for all doors over 3048mm x 2134mm (10'0" x 7'0") and up to 4877mm x 2438mm (16'0" x 8'0"). Frames are supplied as a kit for on-site assembly to the door. Jambs are 75mm wide and the head is 60mm (2.2/3") high. Minimum door height 1930mm (6'4").

Steel Frames (Standard Sizes or Made to Measure)	Low maintenance white, brown or black
60mm to suit Canopy doors gear pre-fitted to doors	135
75mm to suit single Retractable doors with gear pre-fitted to doors	155
75mm to suit double Retractable doors Supplied as a kit for on-site assembly	260

## ELECTRIC OPERATORS

### Electric Operators (belt drive as standard) & Boom Options

Auto-Over 260 (For retractable doors)	371
Auto-Over 270 (For retractable doors)	450
Auto-Over 280 (For retractable doors)	500
Medium extended toothed belt drive boom	21
Long extended toothed belt drive boom	53

### Operator Accessories Comfort Series

572 Uni-directional micro handset	52
564 Uni-directional mini handset	55
663 Bi-directional mini handset	75
645 wireless wall switch with status indicator & motion sensor	95
644 wireless wall switch with status indicator	90
525 four channel wireless keypad	93
526 four channel wireless keypad with cover	98
528 two channel fingerprint scanner	208
Photocell safety beam	70
Wired wall switch	12
Previous Model handset 868 mHz works with socket receiver	50
Impulse socket receiver	80
Battery Backup	180
Special 108 security device	40
Emergency release (Barrel type)	50
External two channel receiver	120
Bowden Cable 311 emergency release retractable doors with handle	28



**G.R.P. CROWN RANGE****• 3 Crown G.R.P. Doors (Standard)**

Garage doors in standard and made to measure sizes, featuring a corrosion protected steel chassis to provide added strength and rigidity. Available with canopy or retractable gear. Available with window options where applicable.

**• 4 Crown G.R.P. Doors**

Garage doors in standard and made to measure sizes, featuring a corrosion protected steel chassis to provide added strength and rigidity. The back of the door panel is covered with a "flowcoat" of resin for increased rigidity and a neat interior finish in light reflecting white. Available with canopy or retractable gear. Available with window options where applicable.

**• Chassis Colour**

White doors will come on a white chassis, ebony woodgrain doors on black chassis and all other woodgrain colours on brown chassis.  
Red, Green and Blue colours and Coastal colours on a white or black chassis.

**GEARING****• Canopy Gear**

Canopy doors between 1930mm (6'4") and 2134mm (7'0") high and up to 2438mm (8'0") wide are fitted with Canopy gear featuring high security two point locking and five point retention.

**• Single Retractable Gear**

All retractable doors between 1930mm (6'4") and 2134mm (7'0") high and up to 3048mm (10'0") wide are supplied with straight arm gear with multi springing. Two point locking is standard on most doors.

**• Double Retractable Gear**

All doors over 2134mm (7'0") high and all doors over 3048mm (10'0") wide are supplied with this gear. All have multi-springing feature.

**LOCKING**

All Wessex doors are supplied with secure two-point locking as standard. Optional brass effect lock available.

**GENERAL INFORMATION****• Handle Positions**

These will vary between canopy and retractable doors of the same size and same style, and between doors of different sizes of the same style with the same gear.

**• Handle Holes**

These will be drilled as standard. If a handle hole is not required this must be clearly stated at time of ordering.

**• Glazed G.R.P. Doors**

All window design doors are fitted with standard black (opaque) windows, which cannot be seen through. Clear and stippled translucent windows are available as options on 3 Crown doors only.

**• Matching Woodgrain G.R.P. Doors**

Where doors are to be fitted in close proximity and are required to be coloured as closely as possible, it is vital that they are clearly requested 'To Match' at time of ordering.

**• Made to Measure Door Prices**

Take the next door size up e.g. 3810mm (12'6") wide x 2032mm (6'8") high take the 3962mm (13'0") price. Note: Where a price is marked \* please refer to the size parameter details below the price for the actual maximum / minimum door size available. Made to measure doors are available in 5mm increments.

**• Opening Size**

All door sizes stated in this price list refer to internal frame dimensions. Due to the bespoke nature of Wessex garage doors we regret we can not accept order cancellations.

**• Top & Bottom Rails & End Stiles**

Top, bottom and end stiles (edges) may vary in width or height between doors of the same style depending on size ordered. This is to enable us to cater for your particular size of garage door. If in doubt, please refer to Wessex before ordering.

**FINISHING & MAINTENANCE****• G.R.P. Doors**

Please study the cleaning and maintenance label attached to the back of the door for advice on keeping your door in top class condition.

**• Steel Frames**

Primed steel frames require a suitable undercoat and topcoat to be applied shortly after delivery in order that the product warranty is not invalidated.

**• Door Lubrication**

All doors require regular (6 monthly) lubrication of the pivot points and bearings. Full details are contained in the Wessex Service Passport supplied door.

	Comfort 260	Comfort 270	Comfort 280
Max. push and pull force (max. N)	550	750	1,000
Travel speed (max. mm/s)	160	160	160
Power consumption / standby (max. W)	4.0	4.0	4.0
Light equivalent to a light bulb with (W) / can be increased to	40 / 80	40 / 80	40 / 80
Battery backup (optional)	<input checked="" type="checkbox"/>	<input checked="" type="checkbox"/>	<input checked="" type="checkbox"/>
Door width (max. m)			
a) One-walled sectional doors	5.0	5.5	6.0
b) Two-walled sectional doors	3.0	5.5	6.0
c) Up and over doors	3.5	5.0	6.0
d) Retractable up-and-over and canopy doors up to 2.25 m door height	3.5	5.0	6.0
Door weight (max. kg)	90	165	200
Rechargeable battery	<input checked="" type="checkbox"/>	<input checked="" type="checkbox"/>	<input checked="" type="checkbox"/>

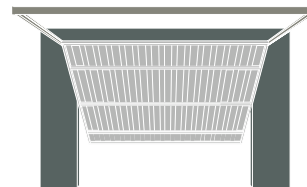
**AUTOMATION**

Up-and-over doors

## SIDE-HINGED GARAGE DOORS

## PLATINUM COMPOSITE SIDE-HINGED

## STANDARD SIZES

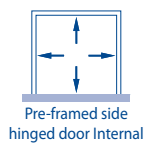

Pre-framed side hinged door Internal frame size

Width x Height (mm x mm)

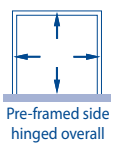

Pre-framed side hinged overall frame sizes shown\*

Width x Height (mm x mm)

Max Height	7'0" 2134mm	7'0" 2134mm	7'0" 2136mm	7'0" 2136mm	7'0" 2136mm	7'0" 2136mm	7'0" 2136mm	7'0" 2136mm	7'0" 2136mm	7'0" 2136mm
Max Width	7'0" 2134mm	8'0" 2438mm	8'0" 2438mm	8'0" 2438mm	8'0" 2438mm	8'0" 2438mm	8'0" 2438mm	8'0" 2438mm	8'0" 2438mm	8'0" 2438mm
Min Height	6'6" 1981mm	6'3" 1905mm	6'4" 1931mm	6'4" 1931mm	6'4" 1931mm	6'0" 1828mm	6'0" 1828mm	6'6" 1981mm	6'4" 1931mm	6'4" 1931mm
Min Width	6'6" 1981mm	6'3" 1905mm	6'11" 2109mm	6'11" 2109mm	6'11" 2109mm	6'0" 1828mm	6'10" 2083mm	6'10" 2083mm	6'10" 2083mm	6'10" 2083mm



Size Code\*



MAJESTIC

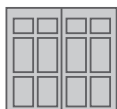

GEORGIAN



LYMINGTON



SHERWOOD

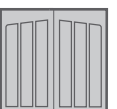

LOXWOOD

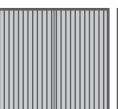

YORK

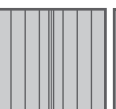

RIPON

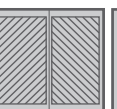

COUNTY

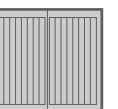

FRENHAM

Gloss White

1830 x 1830	1950 x 1890	6060	-	-	-	-	-	1296	1296	-	-
1984 x 1830	2104 x 1890	6660	-	-	-	-	-	1296	1296	-	-
1984 x 1931	2104 x 1981	6664	-	1386	-	-	-	1296	1296	-	-
1984 x 1981	2104 x 2041	6666	1422	1386	-	-	-	1296	1296	-	-
1984 x 2136	2104 x 2196	6670	1422	1386	-	-	-	1296	1296	-	-
2134 x 1830	2254 x 1890	7060	-	1386	-	-	-	1296	1296	-	-
2134 x 1931	2254 x 1991	7064	-	1386	1615	1615	1500	1296	1296	-	1500
2134 x 1981	2254 x 2041	7066	1422	1386	1615	1615	1500	1296	1296	1500	1500
2134 x 2136	2254 x 2196	7070	1422	1386	1615	1615	1500	1296	1296	1500	1500
2259 x 1931	2379 x 1991	7564	-	1444	1672	1672	1558	1354	1354	1558	1558
2259 x 1981	2379 x 2041	7566	-	1444	1672	1672	1558	1354	1354	1558	1558
2259 x 2136	2379 x 2196	7570	-	1444	1672	1672	1558	1354	1354	1558	1558
2284 x 1931	2404 x 1991	7664	-	1444	1672	1672	1558	1354	1354	1558	1558
2264 x 1981	2404 x 2041	7666	-	1444	1672	1672	1558	1354	1354	1558	1558
2284 x 2136	2404 x 2196	7670	-	1444	1672	1672	1558	1354	1354	1558	1558
2439 x 1931	2559 x 1991	8064	-	1444	1672	1672	1558	1354	1354	1558	1558
2439 x 1981	2559 x 2041	8066	-	1444	1672	1672	1558	1354	1354	1558	1558
2439 x 2136	2559 x 2196	8070	-	1444	1672	1672	1558	1354	1354	1558	1558

## MADE TO MEASURE SIZES IN 5MM INCREMENTS

Up to 7'0"	1537	1502	1730	1730	1616	1411	1411	1616	1616
Over 7'0"	-	1560	1788	1788	1674	1469	1469	1674	1674

\*Size code refers to approximate door size excluding frame. No fitting clearance allowed. If door is fitted between the brickwork a minimum of 10 mm clearance over the width and 5 mm over the height should be added to the overall frame size when selecting the door.

## OPTIONS

Option	Per Door
<b>Sherwood</b> Clear or Stippled Windows type*	430
<b>Lymington</b> Clear or Stippled Windows type*	328
<b>Georgian</b> Clear or Stippled Windows type*	328
<b>Georgian</b> Black Windows type*	160
Colour Options available for woodgrain doors, Red (RAL 3020), Blue (RAL 5011), Green (RAL 6009), Beaumont Blue, Bluebell Blue, Seagrass Green, County Cream, Charleston Grey	300
White Flowcoat to rear of door	130
Side Hinged Left Hand Leaf leading (RH standard, viewed from outside)	70
Side Hinged Pair of Stays	60
Anodised White Aluminium Handle	92
Anodised Chrome Effect Handle	117

Side hinged doors include a frame as standard in Black / White / Brown - please specify the required colour.

A black lever handle is supplied as standard.

The handle will be positioned approximately central to the active door leaf edge, this may vary dependent on door style and/or door feature position.

The Ripon / York / Lymington are available as 2/3: 1/3 opening on doors up to 7'0".

The Majestic is 2/3: 1/3 available up to 7'.

The 1/3 door leaf is a fixed width of 800mm and always leading.

\*Please specify leading requirements

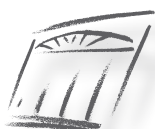



### Side-hinged Garage Door Specifications

Platinum doors are built onto a steel chassis that provides a neat edge to the door panels and gives the door strength and rigidity.

The chassis is available in white, brown or black. White doors will come on a white chassis, ebony woodgrain doors on black chassis and all other woodgrain colours on brown chassis. Red, Green and Blue colours and Coastal colours on a white or black chassis.

Frames are provided in a matching colour.

Side hinged doors have a black lever handle that operates a locking latch to the active leaf, whilst the inactive leaf is secured by a shoot latch bolt.

The rear face of the Platinum side hinged doors is white.

### Side-hinged door factory pre-framed

#### Behind brickwork fixing

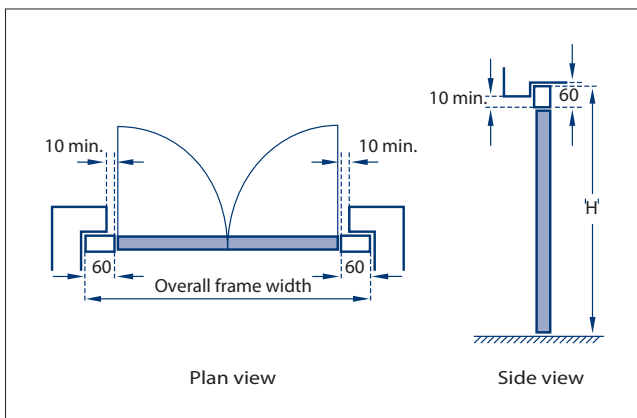

#### Between brickwork fixing

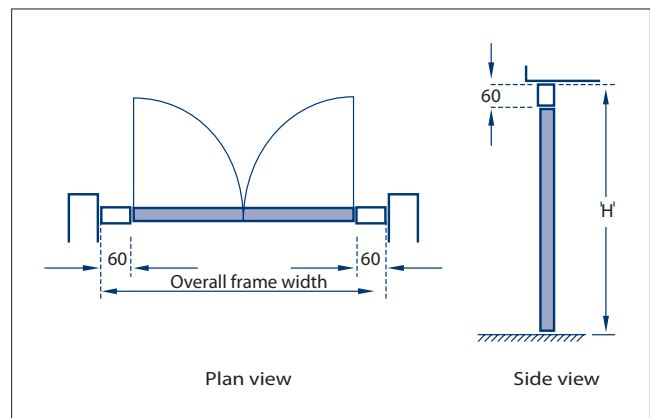

The nominal drive through clearance is 124 mm less than the opening width and 12 mm less than the opening height.

# INSULATED ROLLER GARAGE DOORS



## AUTO-OVER 77 INSULATED ROLLER GARAGE DOOR

### PAINTED COLOURS

White, Black, Cream, Mocca Brown, Burgundy, Graphite, Home Cream, Anthracite, Blue, Racing Green, Chartwell Green, Ruby Red, Moss Green, Silver, Irish Oak, Golden Oak, Rosewood, Walnut.

GUIDE HEIGHT	OVER GUIDE WIDTH (70MM GUIDE) 270mm steel end plates as standard			OVER GUIDE WIDTH (90MM GUIDE) 300mm steel end plates as standard			
	2000mm	2500mm	3000mm	3500mm	4000mm	4600mm	5200mm
2000mm	£1,279	£1,369	£1,500	£1,614	£1,835	£2,039	£2,260
2150mm	£1,289	£1,381	£1,517	£1,625	£1,846	£2,045	£2,272
2300mm	£1,323	£1,415	£1,545	£1,653	£1,948	£2,073	£2,299
2450mm	£1,351	£1,443	£1,642	£1,681	£1,965	£2,209	£2,420
2600mm	£1,466	£1,614	£1,727	£1,798	£2,141	£2,306	£2,641
2750mm*	£1,489	£1,625	£1,738	£1,806	£2,181	£2,556	£2,782
2900mm*	£1,489	£1,635	£1,778	£1,817	£2,193	£2,613	-

\* All doors above 2600mm guide height will be supplied with hexagonal shafts and auto locks

### LAMINATE COLOURS

Golden Oak, Rosewood, Mahogany.

GUIDE HEIGHT	OVER GUIDE WIDTH (70mm GUIDE) 270mm steel end plates as standard			OVER GUIDE WIDTH (90mm GUIDE) 300mm steel end plates as standard			
	2000mm	2500mm	3000mm	3500mm	4000mm	4600mm	5200mm
2000mm	£1,505	£1,670	£1,852	£2,016	£2,318	£2,607	£2,891
2150mm	£1,653	£1,676	£1,863	£2,027	£2,329	£2,613	£2,914
2300mm	£1,699	£1,744	£1,937	£2,096	£2,380	£2,687	£2,987
2450mm	£1,755	£1,783	£2,050	£2,164	£2,493	£2,868	£3,146
2600mm	£1,914	£2,050	£2,181	£2,385	£2,754	£3,061	£3,299
2750mm*	£2,039	£2,062	£2,193	£2,391	£2,812	£3,066	£3,697
2900mm*	£2,085	£2,101	£2,209	£2,408	£2,953	£3,175	-

\* All doors above 2600mm guide height will be supplied with hexagonal shafts and auto locks

FULL & HALF BOX	OVER GUIDE WIDTH						
	2000mm	2500mm	3000mm	3500mm	4000mm	4600mm	5200mm
1/2 Box	£114	£125	£137	£148	£165	£176	£194
Full Box	£181	£188	£211	£239	£262	£296	£324
1/2 Box* Graphite, Golden Oak & Rosewood	£266	£276	£288	£298	£308	£320	£330
Full Box* Graphite, Golden Oak & Rosewood	£342	£352	£362	£374	£384	£396	£406

\*Includes matching guides.

Doors supplied with half or full boxes are supplied with 300mm aluminium head plates.

**MATCHING GUIDES ONLY** In Painted Golden Oak, Painted Rosewood and Graphite **£52**

## AUTO-OVER 55 INSULATED ROLLER GARAGE DOOR

### PAINTED COLOURS

GUIDE HEIGHT	OVER GUIDE WIDTH (66mm Guide)	
	2000mm	2500mm
2000mm	£1,397	£1,432
2150mm	£1,409	£1,443
2300mm	£1,477	£1,551

### LAMINATE COLOURS

GUIDE HEIGHT	OVER GUIDE WIDTH (66mm Guide)	
	2000mm	2500mm
2000mm	£1,635	£1,761
2150mm	£1,653	£1,778
2300mm	£1,875	£1,931

**FULL BOX\*** \*Auto-Over 55 doors are supplied with half box as standard.

Full Box	OVER GUIDE WIDTH	
	2000mm	2500mm
	£60	£66

**PAINTED COLOURS:** White, Black, Home Cream, Cream, Racing Green, Anthracite, Burgundy, Mocca Brown, Blue.

**LAMINATE COLOURS:** Golden Oak, Rosewood, Mahogany.

### OPTIONAL EXTRAS

Keygo 4 hand transmitter	£63	Vented lath	£31 Linear M
RTS Smoove 1 white wall switch	£47	Vision lath (Powdercoat colours only)	£36 Linear M
Radio Keypad RTS	£119	10m power lead	£38
Radio Keypad RTS (Metal)	£163		
Lockable over-ride cover	£44		
Low level emergency release	£170		
Telis 1 RTS Pure remote control	£58		

All powdercoating prices are NET, not subject to discount.

Actual RAL colours and finish may vary slightly from door curtain colours.

### IMPORTANT NOTES

- Guides/head plates are available to colour match the door colour (except laminated finishes, which are supplied in Vandyke Brown)
- Please note that guides/head plates and bottom lath may vary in colour to the door curtain.
- Approx 55mm of the bottom rail will be visible below the top of the opening when door is in the open position.

PLEASE ORDER BY OVERGUIDE WIDTH AND GUIDE HEIGHT (on official order form).

# TECHNICAL & GENERAL INFORMATION

## Frame Dimensions for Panel Doors

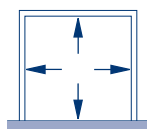

Internal frame size  
On-site timber frame

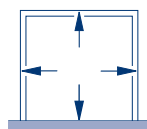

Pre-framed canopy door  
overall frame sizes shown<sup>1</sup>

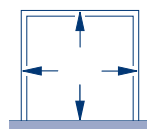

Pre-framed retractable door  
overall frame sizes shown<sup>1</sup>

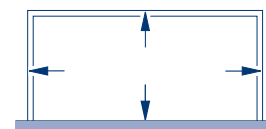

Frame kit for double door  
overall frame sizes shown<sup>1</sup>

Size Code	Width x Height (mm x mm)	Width x Height (mm x mm)	Width x Height (mm x mm)	Width x Height (mm x mm)
6660	1984 x 1830	2094 x 1888	2124 x 1888	-
6663	1984 x 1906	2094 x 1964	2124 x 1964	-
6664	1984 x 1931	2094 x 1989	2124 x 1989	-
6666	1984 x 1981	2094 x 2039	2124 x 2039	-
6670	1984 x 2136	2094 x 2194	2124 x 2194	-
61064	2084 x 1931	2194 x 1989	2224 x 1989	-
61066	2084 x 1981	2194 x 2039	2224 x 2039	-
61070	2084 x 2136	2194 x 2194	2224 x 2194	-
7060	2134 x 1830	2244 x 1888	2274 x 1888	-
7063	2134 x 1905	2244 x 1963	2274 x 1963	-
7064	2134 x 1931	2244 x 1989	2274 x 1989	-
7066	2134 x 1981	2244 x 2039	2274 x 2039	-
7070	2134 x 2136	2244 x 2194	2274 x 2194	-
7076	2134 x 2286	-	2274 x 2344	-
7164	2170 x 1931	2280 x 1989	2310 x 1989	-
7166	2170 x 1981	2280 x 2039	2310 x 2039	-
7170	2170 x 2136	2280 x 2194	2310 x 2194	-
7176	2170 x 2286	-	2310 x 2344	-
7364	2224 x 1931	2334 x 1989	2364 x 1989	-
7366	2224 x 1981	2334 x 2039	2364 x 2039	-
7370	2224 x 2136	2334 x 2194	2364 x 2194	-
7564	2259 x 1931	2369 x 1989	2399 x 1989	-
7566	2259 x 1981	2369 x 2039	2399 x 2039	-
7570	2259 x 2136	2369 x 2194	2399 x 2194	-
7576	2259 x 2286	-	2399 x 2344	-
7664	2284 x 1931	2394 x 1989	2424 x 1989	-
7666	2284 x 1981	2394 x 2039	2424 x 2039	-
7670	2284 x 2136	2394 x 2194	2424 x 2194	-
7676	2284 x 2286	-	2424 x 2344	-
8064	2439 x 1931	2549 x 1989	2579 x 1989	-
8066	2439 x 1981	2549 x 2039	2579 x 2039	-
8070	2439 x 2136	2549 x 2194	2579 x 2194	-
8076	2439 x 2286	-	2579 x 2344	-
8666	2590 x 1981	-	2730 x 2039	-
8670	2590 x 2136	-	2730 x 2194	-
8676	2590 x 2286	-	2730 x 2344	-
9066	2744 x 1981	-	2884 x 2039	-
9070	2744 x 2136	-	2884 x 2194	-
9076	2744 x 2286	-	2884 x 2344	-
1066	3049 x 1981	-	3189 x 2039	-
1070	3049 x 2136	-	3189 x 2194	-
1076	3049 x 2286	-	-	3189 x 2344
1166	3354 x 1981	-	-	3494 x 2039
1170	3354 x 2136	-	-	3494 x 2194
1176	3354 x 2286	-	-	3494 x 2344
1266	3659 x 1981	-	-	3799 x 2039
1270	3659 x 2136	-	-	3799 x 2194
1276	3659 x 2286	-	-	3799 x 2344
1366	3964 x 1981	-	-	4104 x 2039
1370	3964 x 2136	-	-	4104 x 2194
1376	3964 x 2286	-	-	4104 x 2344
1466	4269 x 1981	-	-	4409 x 2039
1470	4269 x 2136	-	-	4409 x 2194
1566	4574 x 1981	-	-	4714 x 2039
1570	4574 x 2136	-	-	4714 x 2194
1576	4574 x 2286	-	-	4714 x 2344
1666	4879 x 1981	-	-	5019 x 2039
1670	4879 x 2136	-	-	5019 x 2194

<sup>1</sup> No fitting clearance allowed. If door is fitted between the brickwork a minimum of 10 mm clearance over the width and 5 mm over the height should be added to the overall frame size when selecting the door.

Height measurement guide

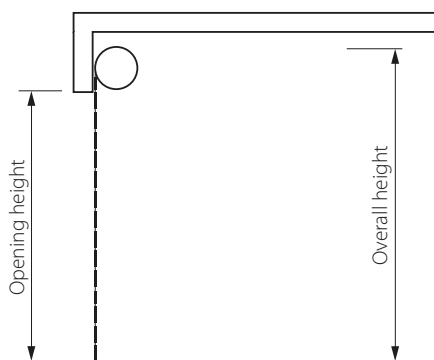

Width measurement guide

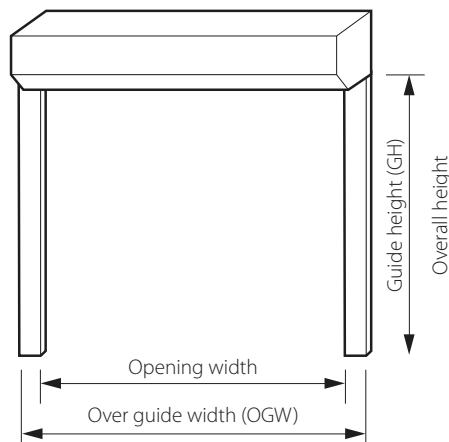

Box end details

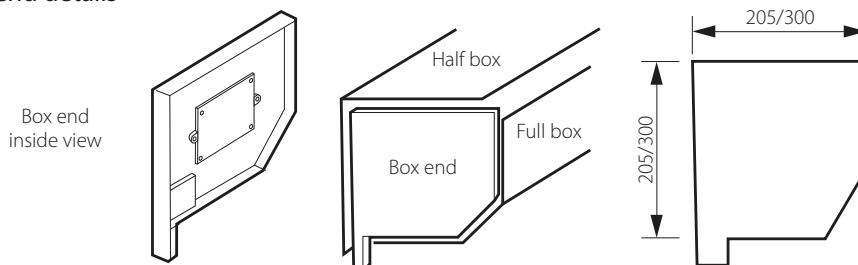

Full and half box (optional extra)

Guide specifications

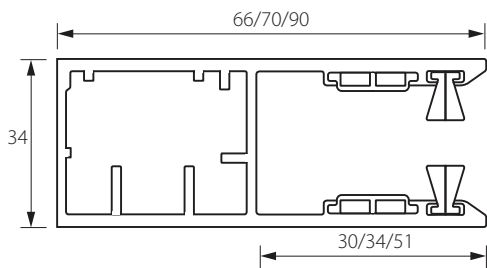

Fixing options

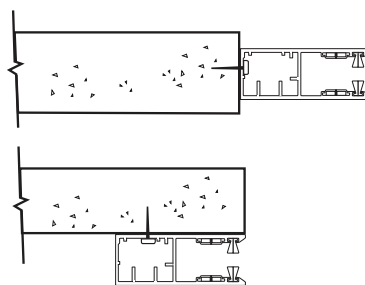

Standard guides: 70mm for doors up to 3500mm high  
 90mm guides for doors over 3500mm high  
 Compact guides: 66mm

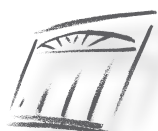

**Canopy Gear Specifications**

The canopy gear allows the door to travel in vertical tracks and is counterbalanced by an overhead torsion spring.

The nominal drive through is 40 mm less than the opening width and 130 mm less than the opening height.

In the open position, the door projects approximately one third of the door height, forming a canopy.

For doors fitted with an operator, please respect operator specifications.

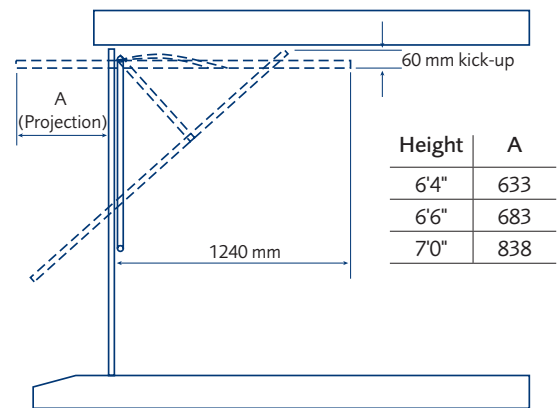

On-site timber frame

**Behind brickwork fixing**

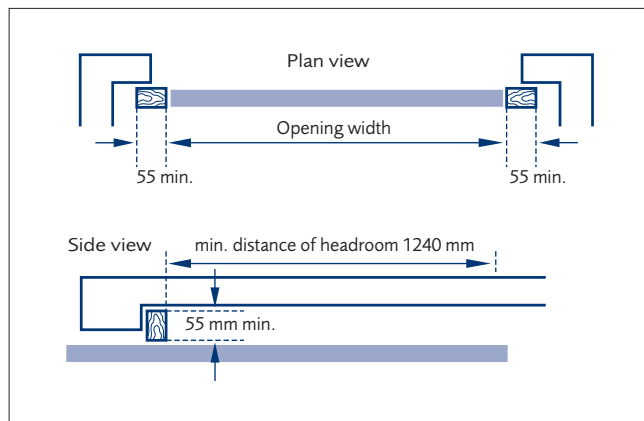

**Between brickwork fixing**

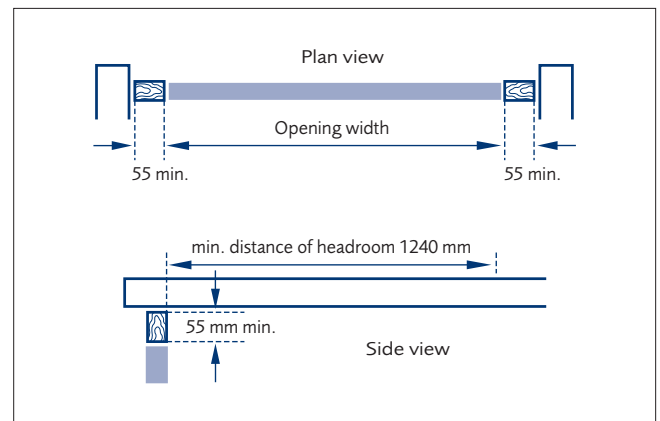

Factory pre-framed with steel box frame

The garage door is supplied factory fitted to a steel box section frame and is secured to the brickwork by using just 7 fixings.

**Behind brickwork fixing**

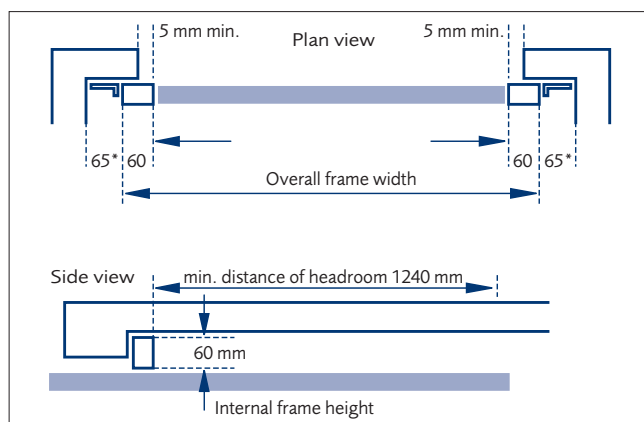

\* width of anchor in this position

**Between brickwork fixing**

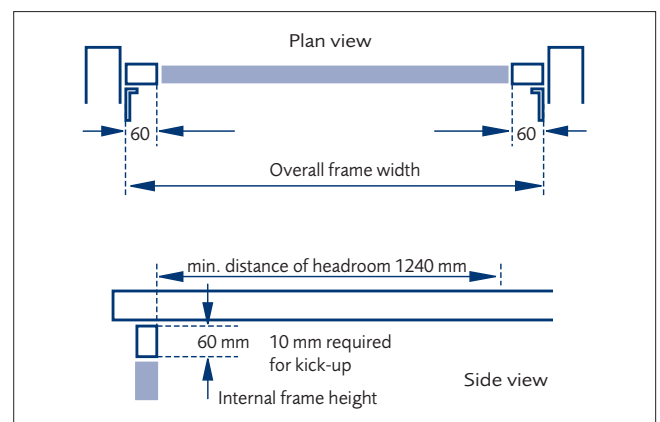

**Single & Double Retractable Gear Specifications**

The retractable gear allows the door to be retracted inside the garage when open by means of horizontal overhead tracks supported by wall or ceiling mounted suspension brackets. This gear is available as an option for single doors and comes as standard with double garage doors.

The nominal drive through clearance is 105 mm less than the opening width and 110 mm less than the opening height for single doors and 140 mm less than the opening height for double doors.

For doors fitted with an operator, please respect operator specifications.

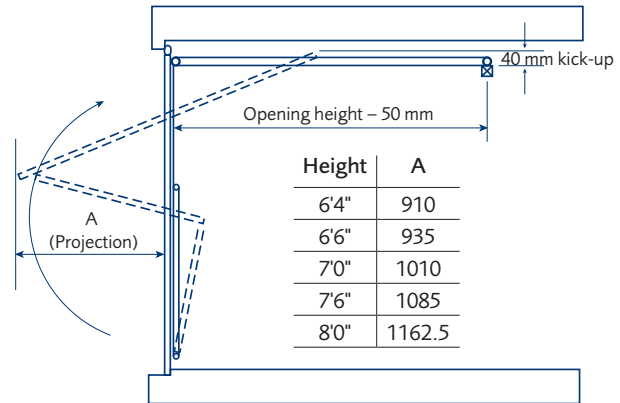

On-site timber frame

Behind brickwork fixing

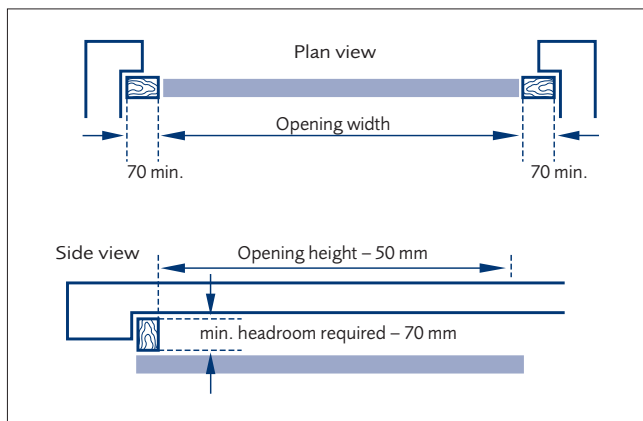

Between brickwork fixing

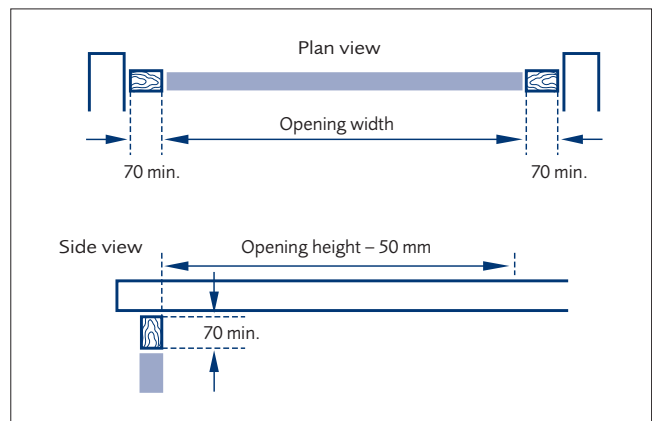

Factory pre-framed with steel box frame

The garage door is supplied factory fitted to a steel box section frame and is secured to the brickwork by using just 7 fixings.

Behind brickwork fixing

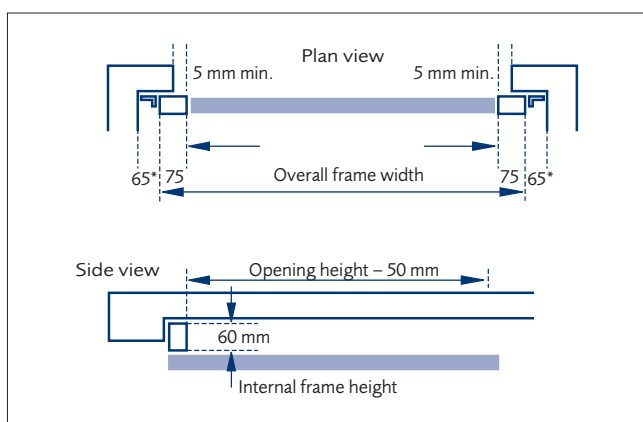

\* width of anchor in this position

Between brickwork fixing

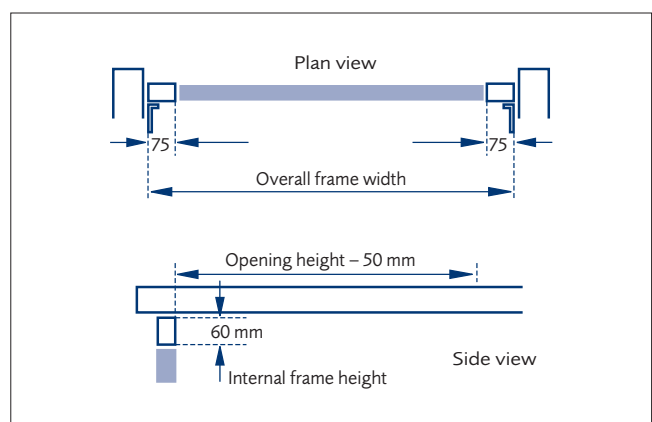



CI/SfB			
127	(31.56)	X	

Date: Feb 2018 Issue 2

Please Note:

- As Wessex GRP Products' policy is one of continuous improvement, we reserve the right to change the specification or withdraw any products without prior notice.
- All details are correct at time of going to press. E & OE.

Product Guarantee – WESSEX GRP PRODUCTS LIMITED. (Wessex)

Subject to conditions set out below;

- Wessex garage doors are guaranteed against any form of manufacturing defect for a period of 2 years from the date of original purchase.
- Wessex electric operators are guaranteed against any form of manufacturing defect for a period of 2 years for mechanical elements, motors and transformers and for a period of 2 years for other electronic and radio equipment.
- The Exterior finish is guaranteed to provide an effective weatherproof membrane which will resist perforation of the substrate from the weather side due to corrosion for the periods indicated below.  
2 years - GRP
- Colour change or fade to the exterior surface will be limited and uniform for a period of 2 years.

## CONDITIONS

- During the comprehensive 2 year guarantee period Wessex GRP Products Limited undertake to repair or replace (at its discretion), and without charge, products or components which have suffered any form of manufacturing defect. Claims must be notified within 3 days from the date of delivery or within a reasonable time after discovery of any defect.
- Products covered by these guarantees must have been purchased through an authorised Wessex garage door distributor or as original equipment attached to a newly built dwelling.
- The warranties shall apply for normal use only. Normal use constitutes no more than 5 operations (open/close cycles) per day.
- The warranties offered attach to the Wessex product only and no consequential damages will apply no matter how caused.
- No liability will be accepted as a result of normal wear and tear, incorrect storage, incorrect handling, faulty installation, incorrect use, non adherence to routine maintenance schedule or wilful damage..
- Claims under this guarantee must be made through the original supplier and accompanied by relevant documentation indicating the date of purchase (e.g. receipt).
- Wessex GRP Products Limited maximum liability shall be the original purchase price inclusive of Value Added Tax at the rate prevailing when supplied.
- Any product which is the subject of a claim:
  - must have been correctly installed in accordance with the installation instructions supplied and thereafter properly maintained by a suitably experienced engineer on a regular basis as set out in the Maintenance and Operating Instructions provided with every door. (Additional copies of these instructions are available by calling 01942 832 355). We recommend that regular maintenance is provided by a suitably experienced engineer. See your Yellow Pages for your local Wessex Garage Door or AGDS specialist.
  - must have the manufacturers reference number still intact (found on the barcode label on the door)
  - must not have been modified in any way.
- Claims will not be accepted where the cause is due to:
  - impact or mechanical damage suffered during or following installation, e.g scratches, indentations, tears, scuffs or other surface abrasion.
  - damage or discolouration caused by contact with any form of caustic, abrasive or corrosive substance, fumes, bird droppings, fire, smoke, floodwater, salts, acids, or from exposure to abnormal atmospheric pollution.
- This guarantee excludes normal wear and tear on items such as cones, cables, spindles, lock cylinders, hinges or springs.

- Only Wessex original spare parts must be used when required. The use of non-Wessex parts shall invalidate this guarantee. Warranty period for replacement parts is 6 months or the balance of the original warranty period if greater.
- The Exterior Finish Guarantee applies only to the weatherside surface and where more than 5% of the surface area of the door is affected. Surfaces must be freely exposed to washing by rainfall and kept clear of accumulated dirt and debris and given equal exposure to local environmental conditions and consistent natural lighting conditions across the face of the door. Special attention is drawn to Clause (9) (i).
- The guarantee period for electric operators excludes batteries, fuses and light bulbs.
- Parts replaced free of charge become the property of Wessex GRP Products Limited.
- Attempted repairs by non-qualified individuals shall invalidate this guarantee.
- The specific terms of this guarantee shall only apply to products purchased on or after August 2010 within the UK and Eire.
- Wessex garage doors and associated products are sold subject to the Wessex GRP Products Limited Standard Terms and Conditions of Sale, copies of which are available upon request. Wessex GRP Products Limited shall not be liable as a result of any representation, implied warranty or other term or condition or for any consequential loss or damage, costs, expenses or other claims whatsoever except as expressly set out in these Terms and Conditions of Sale.

## General Advice

## Door Cleaning

Periodically clean the door panel using warm water and a soft cloth or sponge. Allow to dry naturally. Never use detergent, abrasive, caustic or solvent based cleaners as they may damage the door surface. Bird droppings should be removed immediately as these can be particularly caustic.

## Customer Maintenance

Moving parts should be lubricated regularly to ensure smooth operation. Every six months visually inspect all wear items (including cables) for signs of wear. If wear is detected we recommend you contact your local Wessex approved service engineer to arrange for a replacement. Garage door springs are under extreme tension and should only be repaired or replaced by a suitably qualified engineer.

## Other performance issues affecting Wessex. garage doors are:

Wessex G.R.P. doors are individually handcrafted products manufactured to specific customer order. Due to the nature of the product and the hand finishing processes used they may occasionally display small blemishes which do not detract from the overall appearance of the product. These are regarded as being within manufacturers tolerance when such blemishes are not visible to the naked eye when viewed from a distance of three metres. Similarly, Woodgrain effect products will, like the natural material, display colour variations across their surface and colour will vary from door to door. Ordering doors to match helps reduce the variation but will not eradicate it entirely.

Translucency of the door panel may vary when viewed from the inside on a bright day due to variations in laminate thickness. This does not represent a manufacturing defect and overall performance is not affected.

Size and Deflection - the natural curing process does not affect the ultimate product size and a tolerance of  $\pm 6$ mm on both height and width is deemed acceptable. One piece up and over doors in the 'open' position will display a level of vertical deflection or 'sag' across the width of the panel and up to 6mm per linear metre is within design tolerance.

These terms and conditions do not affect your statutory rights.

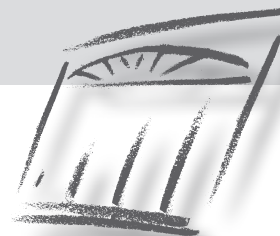

**wessex**  
DOORS