

SteelGuard Range

SAMSON

GarageGuard

Strong, versatile and durable external doorsets



Our strength is in our name



TEN YEAR GUARANTEE

Our doors are manufactured in a range of materials offering strength and durability. Our SteelGuard Range of external doors are manufactured using magnelis sheets and can offer an anti-corrosion warranty of up to 10 years with a standard PPC coating.*



MADE TO MEASURE

All steel doors are made to order at our UK factory, are available in a wide range of heights and widths to suit any requirement, and are delivered fully assembled

Samson

SAMSON GarageGuard



The exceptional external steel doorset for security.

High Security 55mm thick double skinned steel hinged doorset designed to protect your garage and outside buildings.

Factory assembled as standard and ready for an easy on site installation.

Recent investments in machinery have made the process of purchase and manufacture much quicker, meaning less of a wait for your product while maintaining the same level of quality-control and value for money.

You can expect more from us

Quality and security are two areas where compromise is not acceptable. In designing our **GarageGuard** specification we have looked at the real world expectations our products will be marked against and consequently we include much more within our basic external doorset than other manufacturers.

Every GarageGuard has the following as standard:

- ✓ 55mm door leaf, thicker than others with a choice of infill offering up to 1.6w/m²k thermal value
- ✓ Hooply multibolt locking with SBD recommended TS007 3 star cylinder & escutcheon sets providing quality & secure locking
- ✓ Door leaf constructed from magnelis for industry leading corrosion resistance offering a 10 year warranty against corrosion.
- ✓ U Channel adjustment sections allowing greater tolerance in opening while also cloaking fixing points and minimising mastic gaps.
- ✓ Aluminium threshold strip/ weather bar with rain deflector for inward opening doorsets.
- ✓ 4 number stainless steel dog bolt hinges per leaf
- ✓ All doors fully CE marked with full Declaration of Performance as required by current legislation

The little extras that count...

As well as always including adjustable fixing feet and variable sub-frames as standard, we also include a number of useful extras to make fitting our doors simple and straightforward.

You also get as standard:

- ✓ Hardware is already fitted to the door in the factory saving time and effort on site.
- ✓ Locks are always fitted into a purpose made internal reinforcement box not hung from the fore end plate loose into the leaf
- ✓ Self cutting frame fixings and cover caps are provided along with spare hinge screws and driver bits.
- ✓ A full fitting kit is supplied with each order including 12mm allen key to make frame adjustment easy and a selection of drills for fitting into concrete or steel.
- ✓ A pot of touch up paint
- ✓ A tube of clear mastic for use during installation to prevent water ingress under the threshold.
- ✓ 10 year anti corrosion warranty as standard.

DOOR LEAF

Thickness:	55mm
Material:	1.2mm corrosion resistant Magnelis [®] steel sheets as standard, wide variety of colours and finishes available. Also 304 or 316 grade Stainless Steel.
Infill:	Self supporting resin-impregnated honeycomb core as standard. Optionally Mineral Wool, Polyurethane or Solid Timber.
Construction:	Doorblade manufactured from two 1.2mm sheets lockformed together, by bonding skins around a rigid core, using a no-weld construction.

THERMAL 'U' VALUES

Depending on construction and infill values of 3.2 - 1.6 w/m²k are obtainable.

Infill:	U Value (w/m²k)
Honeycomb	3.1
Solid Timber	2.9
Mineral Wood (with steel strengtheners)	2.4
Mineral Wood (lamella)	1.8
Polyurethane	1.6

DOOR FRAME

Construction: Folded from 1.6mm Magnelis®. Screw and tab construction with 4no. adjustable fixing feet per jamb, variable sub frame supplied as standard to accommodate site tolerance of -0/+30mm. The frame is fitted with 4no. Dog-bolt hinges as standard.

Profile: Types A and B available in both inward and outward opening versions.

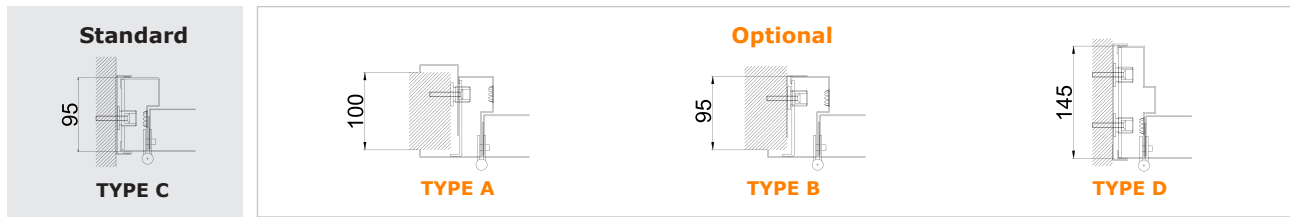

THRESHOLD Optional dropseals and/or rain deflectors are available.

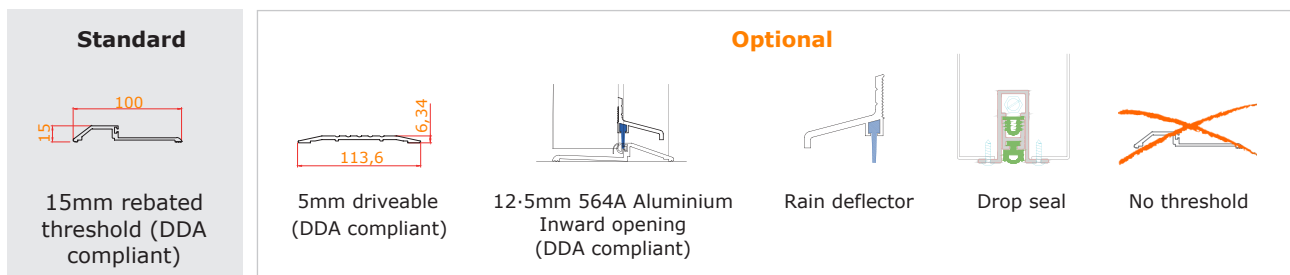

SIZES

All of our doors are made to measure!

Sizing: Doors are custom manufactured in 10mm increments for single openings 690mm to 1290mm and double openings 1290mm to 2600mm, at heights up to 2900mm.

Contact the Sales office on 01933 44 88 50 for special configurations and finishes.



VISION PANELS

Guidance notes: To comply with Part M of the Building Regulations 2004 doors circulation across routes should have visibility glazing. (Vision panels less than 50% of the total door area are exempt from Part L of the Building Regulations).

Construction: Welded construction from 1mm cold rolled steel, screwed together from one side

Options: Double Glazed as standard. Alternative options include 6mm GWPP or a 19mm Double Glazed Unit (6.4/6.4 mm laminate). Custom sizes and glass are available to customer requirements

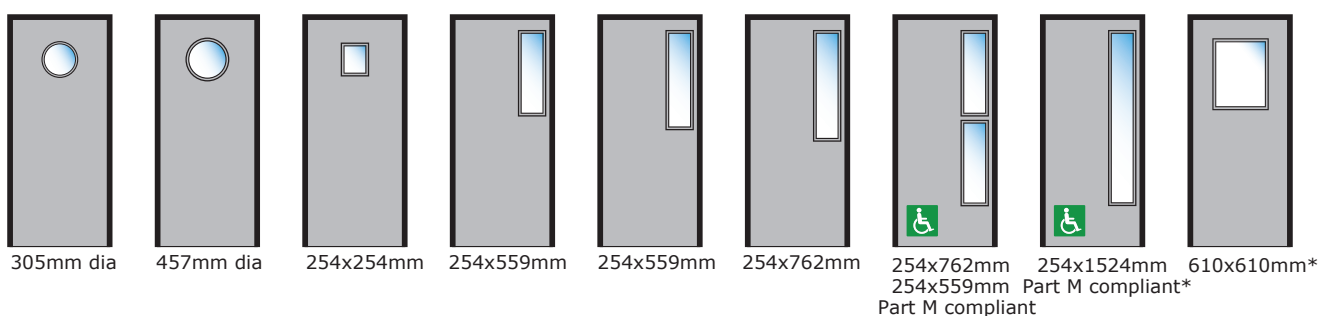
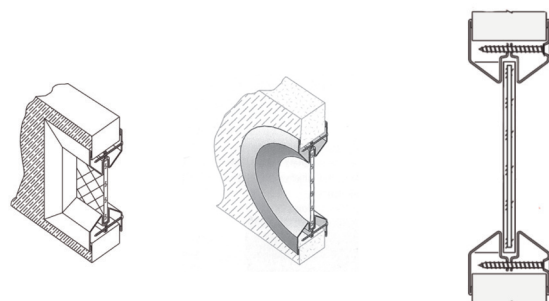
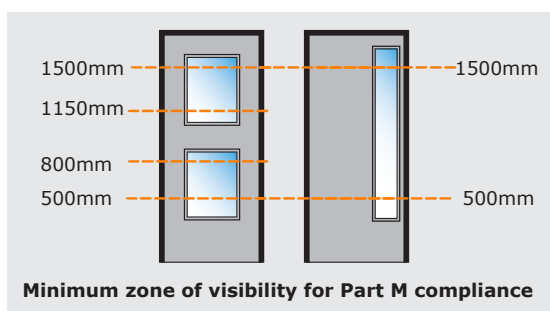

LOUVRE PANELS

Construction: Standard Louvre offers 50% air flow with louvre blades constructed to stop birds. Frames are 1.2mm thick and blades 0.7mm.

Options: Fly mesh available as an optional extra, also custom sizes.

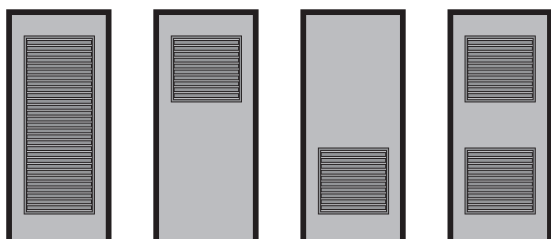

457x1524mm

457x457mm
top

457x457mm
bottom

457x457mm
twin



FINISHES

** Did you know we send out touch up kits with every door*



Standard

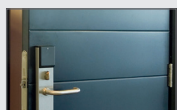

Polyester Powder Coated from Standard Colour Range

Optional



Polyester Powder Coated from Non-Standard Colour Range

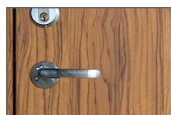

Woodgrain PVC Laminate



Unfinished for site finishing



Individual specifications may vary as we conduct a policy of continuous product development.