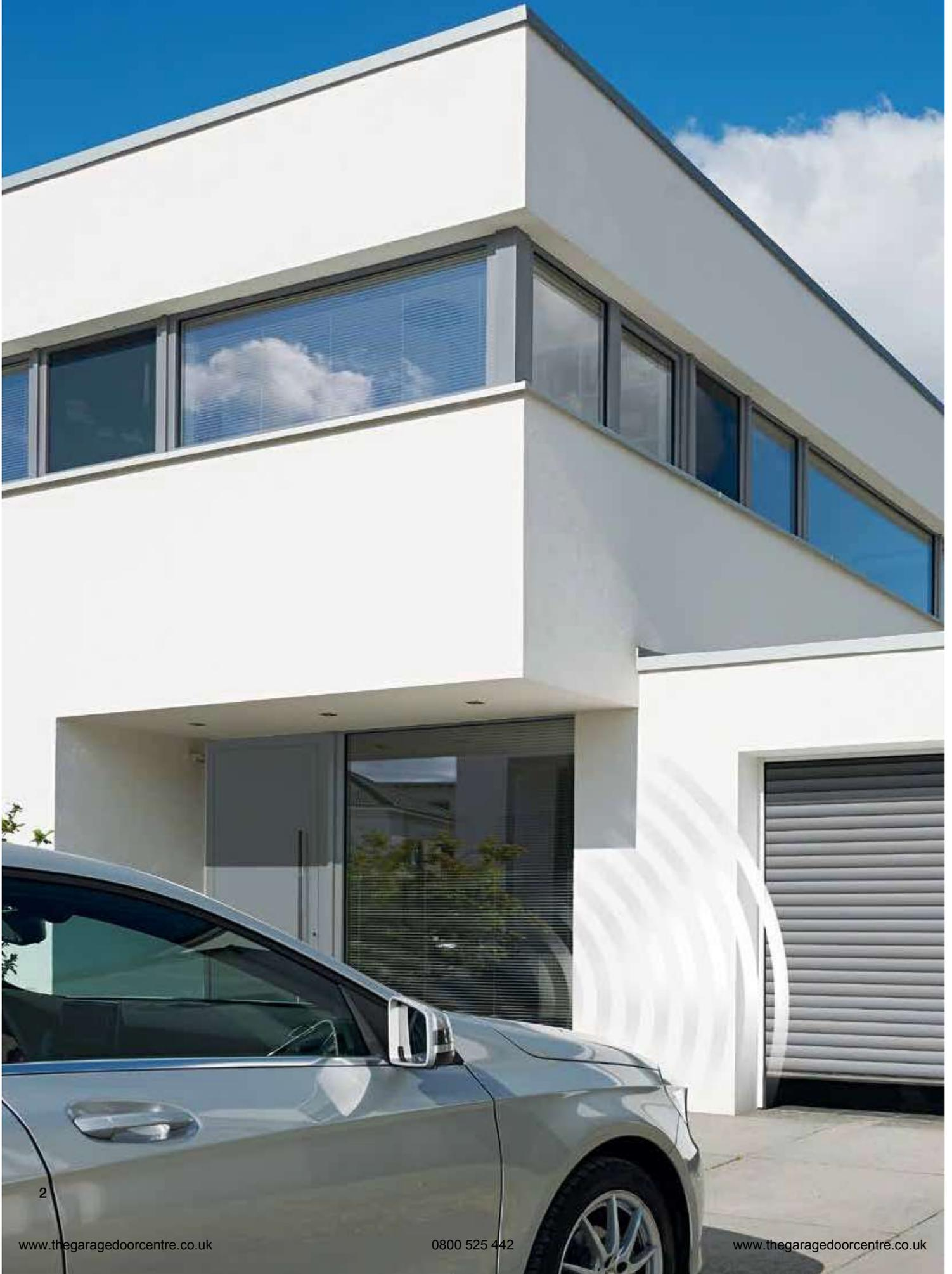


Roller Garage Door RollMatic

NEW: Side door NT 60





6	Good Reasons to Try Hörmann
10	Door Styles
14	Colour
18	Technology
20	External Roller Garage Door
22	Side Doors
23	Variants and Optional Extras
24	Door, Operator and Control
26	Accessories
28	Dimensions and Fitting Data

Some of the doors shown are equipped with optional extras and do not always correspond to our standard models.

The surface finishes and colours shown are subject to the limitations of the printing process and cannot be regarded as binding.

All rights reserved. No part may be reproduced without our prior permission. Subject to changes.

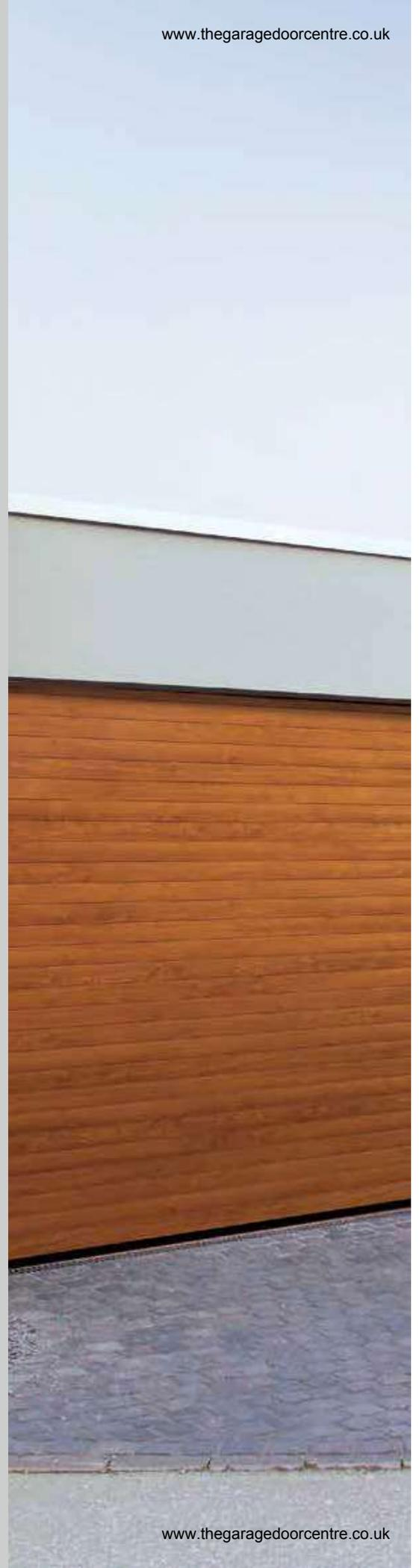
◀ Roller garage door in White aluminium RAL 9006 and Hörmann aluminium entrance door ThermoSafe style 860 in White aluminium RAL 9006

Universally applicable

RollMatic roller garage doors open vertically and require minimum space inside the garage. This construction principle means you can make full use of the space inside and in front of the garage. The ceiling also remains free and can be used for lamps or as an additional storage space.

A Hörmann RollMatic always fits. The shape of the garage door opening doesn't play a role when fitting roller garage doors. A Hörmann RollMatic fits anywhere, no matter whether your garage opening is rectangular or chamfered, or has a segmental or a Norman arch.

The RollMatic is also available as an external roller garage door for fitting in front of the opening for problematic fitting situations with little lintel space and / or sideroom. These are crucial benefits when modernising your home.





“A good reputation must be earned.”

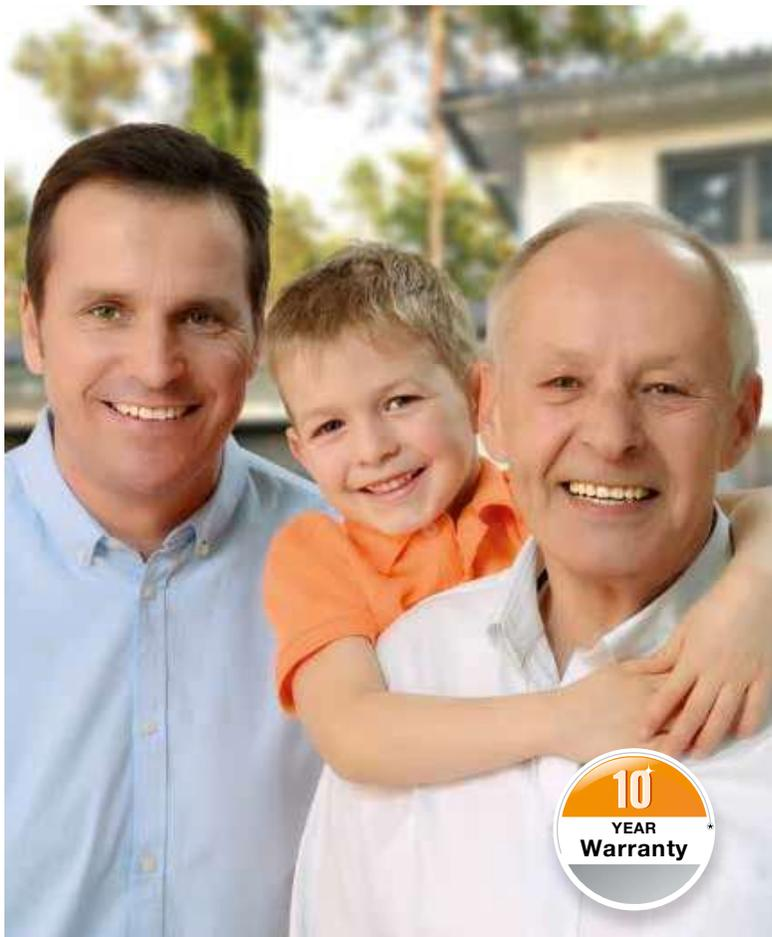
August Hörmann

In line with the founder's philosophy, the Hörmann brand today is a true promise of quality. The family-owned company has over 75 years of experience in door and operator construction and, with sales of over 20 million doors, is no. 1 in Europe. This gives you a reassuring feeling when purchasing a Hörmann roller garage door.



1 Brand quality “Made in Germany”

All doors and operator components are developed and manufactured by Hörmann, are perfectly matched to each other and tested and certified by independent, recognised institutes to ensure your safety. They are manufactured in Germany according to the DIN ISO 9001 quality management system and meet the requirements of European standard 13241-1. Furthermore, our highly qualified employees work intensively on new products, continual further developments and improvements to details. The results are patents and one-of-a-kind products you can depend on.



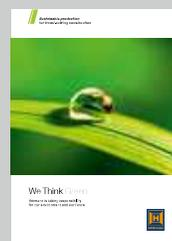
2 Garage doors for generations

Endurance tests under real conditions ensure mature series products with Hörmann quality. Thanks to this, excellent technical solutions and uncompromising quality assurance, you receive a 10-year warranty on all RollMatic roller garage doors and 5 years on all Hörmann operators.

* The complete warranty conditions can be found at: www.hormann.co.uk

3 An eye on the future

Hörmann is setting a good example. This is why, since 2013, the company has obtained 40 % of its required energy from green sources and will continue to increase this percentage. At the same time, many tonnes of CO₂ are saved each year thanks to the introduction of an intelligent and certified energy management system. And last but not least, Hörmann also offers products for sustainable construction. Find out more about Hörmann's environmental activities in the "We think green" brochure.





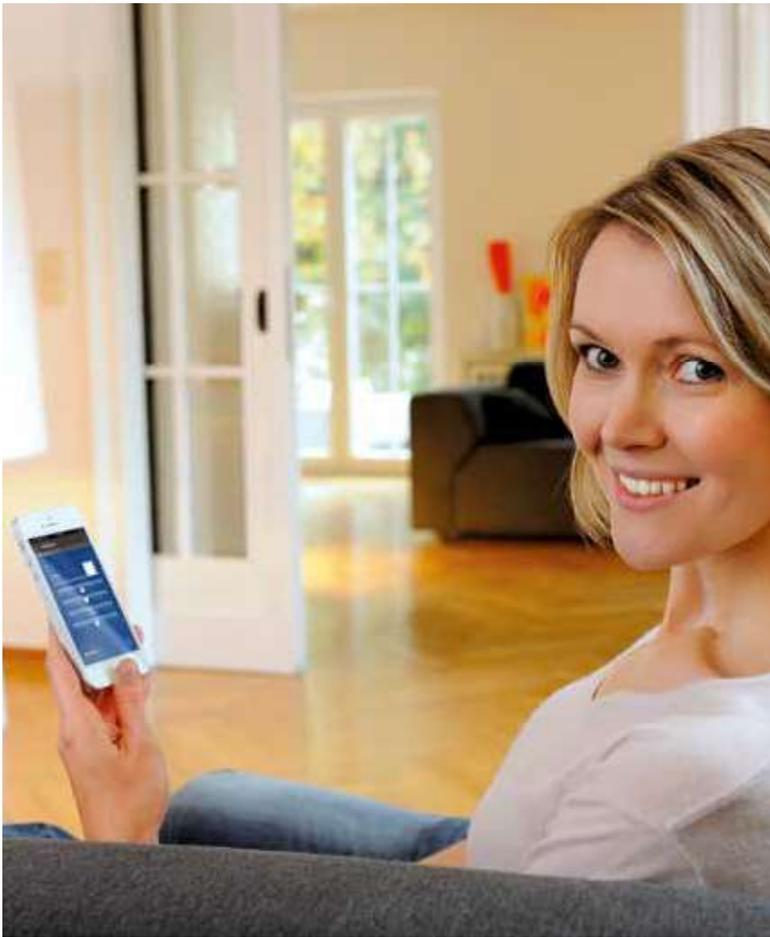
4 Reliable and safe: the tension spring assembly

 Only from Hörmann

The proven tension spring assembly supports the operator during the opening and closing of the door. This preserves the operator mechanism. In case of emergency, the door can be easily opened by hand. A crank handle is not necessary. Double cabling additionally protects the door from crashing to the floor.

5 Maintenance-friendly and especially quiet

As standard the operator is located outside the barrel casing for trouble-free maintenance. The start and stop of the RollMatic door are particularly soft and silent, preserving the door. The spring compensation and reliable automatic cut-out render an additional closing edge safety device unnecessary. An internal push button and light are already integrated in the control housing.



6 BiSecur radio system with certified security

! Only from Hörmann

Our bi-directional, high-security BiSecur radio system for garage door and entrance gate operators is based on future-oriented technology that allows you to conveniently and safely operate garage doors, entrance gates, lights and much more.

The newly developed, extremely secure BiSecur encryption protocol with a stable, interference-free range makes sure that no-one can copy your radio signal. It has been tested and certified by security experts at the Bochum University and has the same high security level as online banking.

Take a look at the video at: www.hormann.co.uk/videos



7 Award-winning design

In addition to a black or white design, BiSecur hand transmitters are characterised by an elegant shape that fits easily in the palm of your hand.

Hörmann's BiSecur hand transmitters with an optional high-gloss surface in a piano lacquer look have received the reddot design award for their exclusive design.



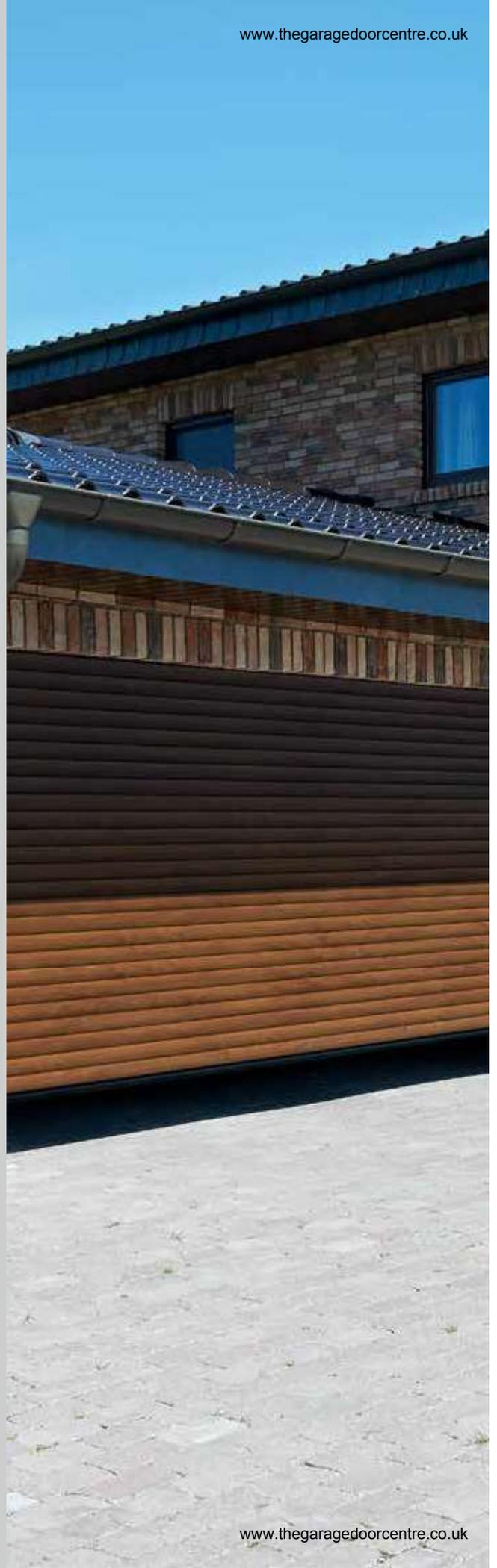
Take a look at the video at: www.hormann.co.uk/videos

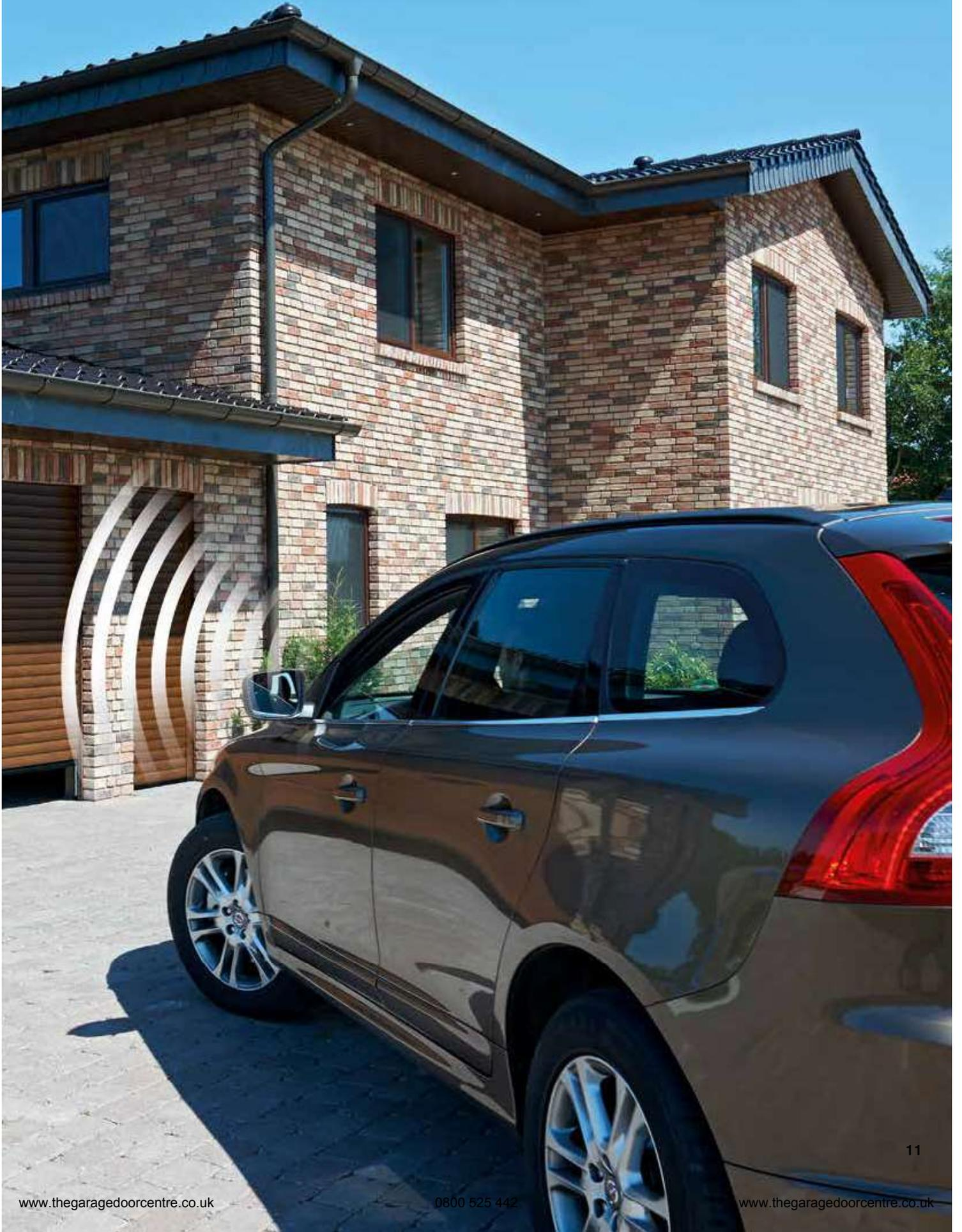


Figure above: HS 4 BS hand transmitter with hand transmitter station (optional).

A complete package with a matching operator

The roller garage door RollMatic has the right solution for every challenge, as it can be individually adapted to the architecture of your home or the fitting situation in the garage. An external rolling shutter is recommended for fitting situations with little lintel space. To ensure the harmonious appearance of your door, we offer the roller garage door RollMatic in various looks. For a natural door look, select one of the two timber designs of the Decograin or Decopaint surface finishes. Or select from one of the 11 equally-priced colours – giving you more options for customisation. It goes without saying that we also offer matching side doors.





ROLLER GARAGE DOOR ROLLMATIC



► Roller garage door and side door in Traffic white RAL 9016





▲ External rolling shutter in Anthracite grey RAL 7016

◀ Roller garage door in Traffic white RAL 9016 and Hörmann aluminium entrance door ThermoSafe style 413 in Traffic white RAL 9016

Harmonious overall appearance

The smooth surface of the aluminium profiles looks modern and elegant, unlike ribbed profiles from other suppliers. Furthermore, a high-quality coating on the inside and outside of the door's surface makes it easy to clean. Only Hörmann offers you the complete door in the selected door colour without a surcharge. The door curtain, guide rails, fascia panel, and shaft cover are thus combined in an attractive and harmonious unit. The hollow space of the profile is evenly filled with polyurethane rigid foam for quiet door travel.



Please note:

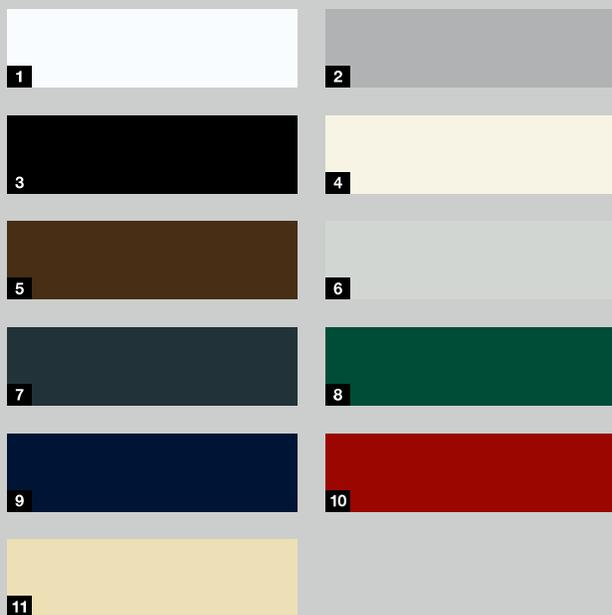
All colours based on RAL.

The colours and surfaces shown are subject to the limitations of the printing process and cannot be regarded as binding.

Please consult with your local Hörmann specialised dealer.

- 1 Profile view (concave side)
- 2 Profile view (convex side)

11 equally-priced colours



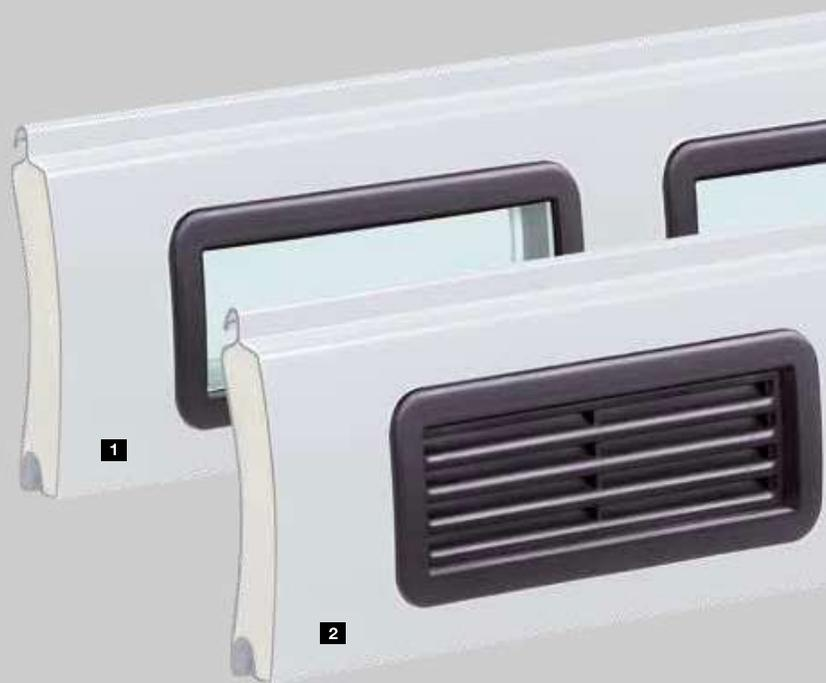
- 1 RAL 9016 Traffic white
- 2 RAL 9006 White aluminium
- 3 RAL 9005 Jet black
- 4 RAL 9001 Cream
- 5 RAL 8028 Terra brown
- 6 RAL 7035 Light grey
- 7 RAL 7016 Anthracite grey
- 8 RAL 6005 Moss green
- 9 RAL 5011 Steel blue
- 10 RAL 3003 Ruby red
- 11 RAL 1015 Light ivory

Glazing elements

Get more daylight in your garage!
The glazing elements with synthetic panes are arranged across the entire profile width. The number of elements depends on the respective door width. A maximum of ten profiles can be fitted with glazings in each door.

Ventilation grilles

Ventilation of your garage improves the room climate and prevents mould. Ventilation grilles made of long-lasting plastic are arranged across the entire profile width. A maximum of ten profiles can be used for each door.



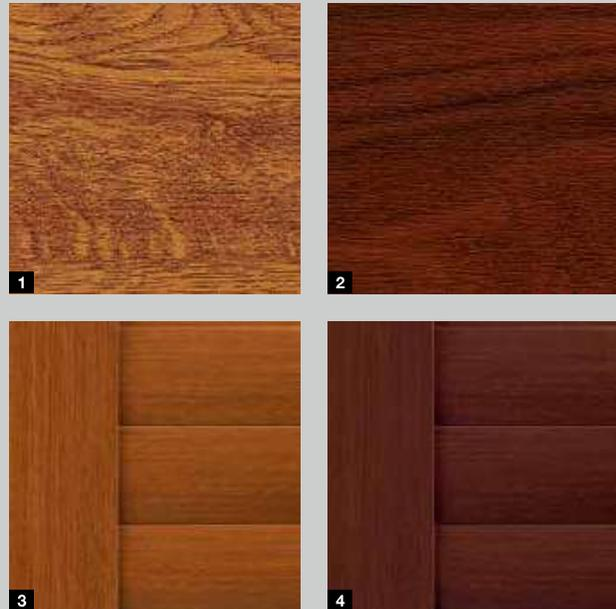
- 1 Profile with synthetic glazing
- 2 Profile with ventilation grille

Decograin surface finishes

The two Decograin surfaces in the colours Golden Oak and Rosewood have a convincingly real timber look. A special wear-resistant surface protection preserves the UV-resistant plastic film coating on the RollMatic over a long time.

To create a uniform appearance, the exterior door curtain, fascia and frame are supplied with a Decograin surface finish. The side guides and curtain interior are painted in brown. Decograin surface finishes are not available for external roller garage doors.

Decograin decors



Please note:

The colours and surfaces shown are subject to the limitations of the printing process and cannot be regarded as binding. Please consult with your local Hörmann specialised dealer.

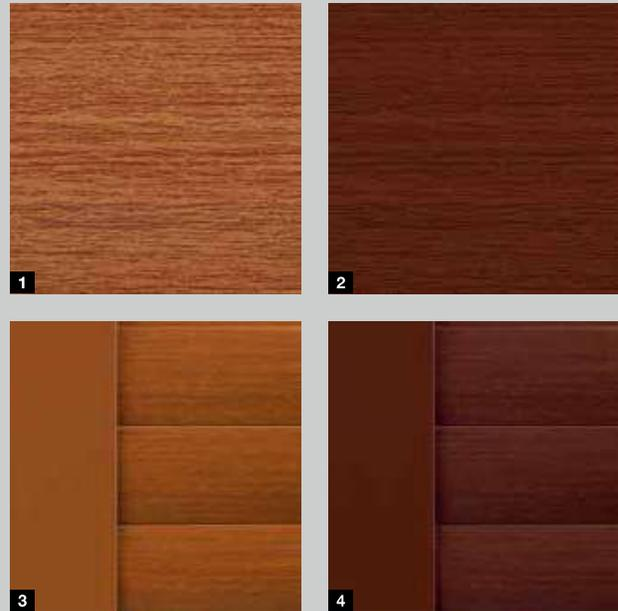
- 1 Decograin Golden Oak
- 2 Decograin Rosewood
- 3 Side guide and profile in Decograin Golden Oak
- 4 Side guide and profile in Decograin Rosewood
- 5 Profile view (concave side) in brown
- 6 Profile view (convext side) in Decograin Golden Oak

Decopaint surface finishes

The Decopaint surface finishes Golden Oak and Rosewood are an affordable alternative to Decograin decors. The interior and exterior of the profiles are painted to look like timber.

Frames, side guides, fascia panels and shaft covers are powder-coated in a base colour matching the timber to create a harmonious appearance.

Decopaint decors



- 1** Decopaint Golden Oak
- 2** Decopaint Rosewood
- 3** Side guides in the base colour of the decor, profile in Decopaint Golden Oak
- 4** Side guide in the base colour of the decor, profile in Decopaint Rosewood
- 5** Profile view (concave side) in Decopaint Golden Oak
- 6** Profile view (convex side) in Decopaint Golden Oak

Details perfectly matched to each other



The RollMatic roller garage door features a wide variety of innovative details with a single objective: providing you with security and comfort. From the particularly simple fitting through to the sophisticated safety patents, this concept runs through all aspects of the product.





Only from Hörmann



Only from Hörmann



4



5



6

1 A well-protected shaft

The standard shaft cover practically prevents reaching into the door barrel. In addition, it protects the curtain from damage and dirt when the door is open. For coloured doors or doors with a Decograin surface, the cover matches the door curtain. For Decopaint doors, the cover is supplied in the base colour of the door.

2 Tension spring assembly with multi-spring system

Hörmann RollMatic roller garage doors with double tension springs and double cabling protect the door leaf from crashing in every door position. The patented multi-spring system and the transparent protective cover prevent broken springs from flying out and thus protect from personal injury.

3 Wear-resistant bearing rings

The use of wear-resistant materials prevents the bearing rings from making marks on the top curtain profiles.

4 Standard wind locks

Hörmann's RollMatic roller garage doors can even withstand large wind loads (up to class 4). The wind locks fitted as standard in the profile ends keep the door securely within its guides. An additional advantage is increased protection from burglary.

5 Easy fitting

RollMatic roller garage doors are quickly and simply fitted. The side guides, fascia panel and operator are bolted to the garage walls and lintel. Subsequently, the curtain is pulled effortlessly onto the shaft by the operator and fixed via belts.

6 Fitting compensation set

With uneven walls, the optional fitting compensation set for flush door fitting can be applied. This is particularly advantageous for modernisations or timber structures.

For more information, consult the technical manual.

The solution for areas with a lack of interior sideroom

The RollMatic is also available as an external roller garage door for fitting in front of the opening if your garage has little lintel space and/or sideroom.

The external roller garage door is supplied as a complete package with a matching operator. The barrel casing and frame come in the same colour as the door to create a uniform and harmonious appearance.





1 Variable operator positions

Depending on the fitting situation, operators for external roller garage doors can either be installed on the left or right. The shaft cover is 100 mm wider in this area and encloses the operator, protecting it from adverse weather effects or from unauthorised interference.



2 Tension spring cladding with vision sections

The vision sections in the spring cladding allow you to conveniently check whether the cable guide or springs are still functional. This gives you security even after many years of use.



3 Secured release

The operator can be easily released from the inside using a hand pulley. You can, for example, open your door by hand from the inside during a power failure. Optionally, the secured release is also available for fitting to exterior walls in a lockable housing. For further information, please see page 27.

A matching side door for every RollMatic roller garage door

At Hörmann, side doors are given just as much consideration. Because the overall appearance is only perfect if the door is perfectly matched. The side door NT 60 ■ **NEW** is available in all surface finishes and colours. The high-quality 60 mm aluminium frame construction is the ideal frame for the door infill and is fastened with glazing beads as standard.



External view



Interior view



Lever handle set as standard

VARIANTS AND OPTIONAL EXTRAS

Manually operated door with manual locking

Thanks to the supporting tension spring compensation, Hörmann roller garage doors are easy to manually open and close from the outside and the inside. From the outside using the handle **1** and from the inside with a pull chain **2**.

The manually operated roller garage door is mechanically locked using interior and exterior handles and a lock. Solid metal bolts extend on the right and left into the side guide.



Chamfered bottom profile

The solution for sloping ground: An aluminium chamfered bottom weather seal compensates for differences in height over the entire door width (max. 300 mm). The profile can be fitted without any difficulty and is simply screwed onto the inserted curtain.

The bottom profile is delivered powder-coated in Jet black (similar to RAL 9005). On request, the bottom profile **3** is also available in a colour matching the door colour.



Additional fascia panel

The additional fascia panel **4** stabilises the fascia panel during fitting in the opening or behind the opening, if the fascia panel can be seen in the opening. It harmoniously covers the lintel without any unattractive fitting holes. The additional fascia panel is available in the colour of the door or with a Decograin surface.



Automatic roller garage door approved as a functioning unit

In RollMatic roller garage doors, the door components, operator and control are optimally adjusted to each other and approved as a functioning unit. The integrated soft start and soft stop of the operator ensures smooth door travel and protects the door. The accessible operator housing facilitates easy maintenance. The control is complete and equipped with a button and a light.



Standard emergency release

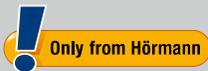
Standard emergency release via a pull cord: The door can be easily pushed open after pulling the cord and does not have to be cranked open.

Reliable automatic safety cut-out

The automatic safety cut-out secures the closing edge and immediately stops the door if there is an obstacle. This way an additional closing edge safety device can be omitted.

As standard

- Impulse control with integrated lighting
- With two HSE 2 BS hand transmitters
- Automatic safety cut-out with obstacle detection



- Emergency release from the inside via a pull cord
- Safety catch through tension spring assembly



Standard 2-button hand transmitter
HSE 2 BS (textured surface)



On encountering an obstruction, the automatic safety cut-out stops the door



1

2

Hand transmitter HS 5 BS

4 button functions
plus query button,
1 High-gloss black or white
2 Black texture



3

4

5

Hand transmitter HS 4 BS

4 button functions,
3 High-gloss black

Hand transmitter HS 1 BS

1 button function,
4 High-gloss black

Hand transmitter HSE 1 BS

1 button function,
incl. eyelet for key ring
5 High-gloss black



6

7

Hand transmitter HSE 2 BS

2 button functions,
incl. eyelet for key ring
6 High-gloss black or white
7 High-gloss green, purple,
yellow, red, orange

(Shown from left to right)



8

9

8 Black texture with chrome
or plastic caps

9 Decors in silver, carbon,
light rootwood, light timber,
dark timber, dark rootwood

(Shown from left to right)



10

11

10 Hand transmitter HSD 2-A BS

Aluminium look, 2 button functions, can also be used as a key ring

11 Hand transmitter HSD 2-C BS

High-gloss chrome, 2 button functions, can also be used as a key ring



12

12 Hand transmitter HSP 4 BS

4 button functions, with button lock-out, incl. key ring



13

14

13 Hand transmitter HSZ 1 BS

1 button function, for insertion in vehicle cigarette lighter

14 Hand transmitter HSZ 2 BS

2 button functions, for insertion in vehicle cigarette lighter



15

16

15 Radio code switch FCT 10 BS

For 10 functions, with illuminated buttons and protective cover

16 Radio finger-scan FFL 12 BS

For 2 functions and up to 12 fingerprints



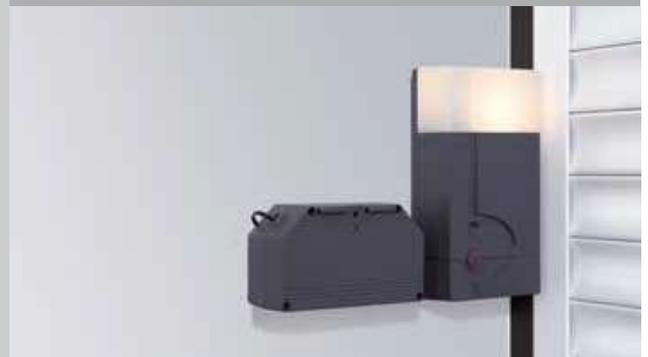
Optional emergency release from the outside

For garages without a second access, we recommend the emergency release to open the door from the outside in case of emergency (e.g. power failure).



Optional acoustic alarm

The shrill alarm sound with a volume of 110 db (A) effectively deters burglars.

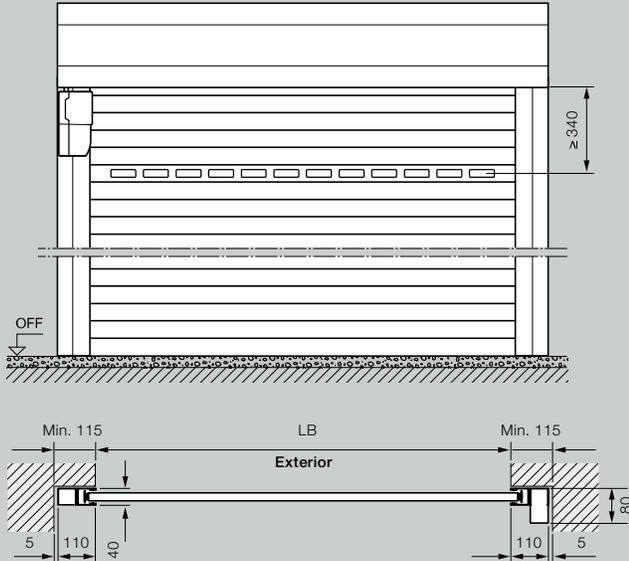


Optional emergency battery

With this emergency power supply, you can bypass network power failures for up to 18 hours and max. 5 door cycles. The emergency battery recharges during normal operation.

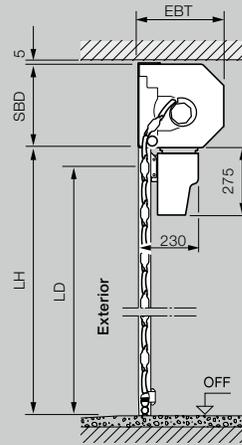
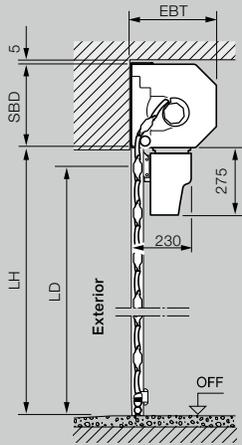
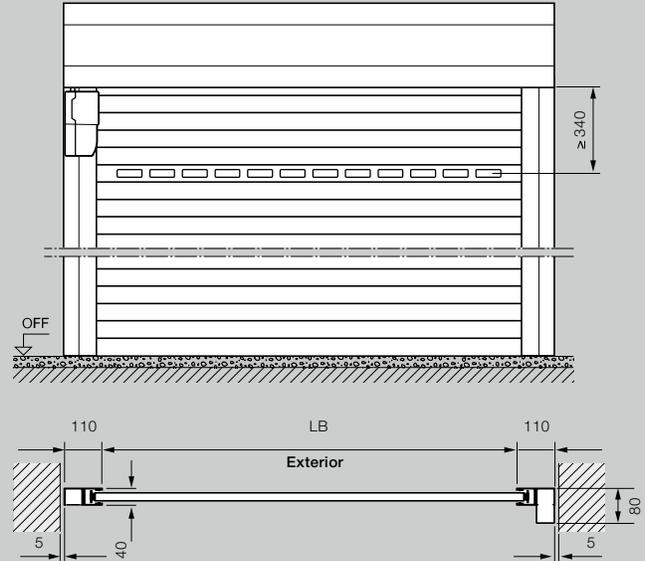
Internal roller garage door

Fitting behind the opening, view of fitting side



Internal roller garage door

Fitting in the opening, interior view

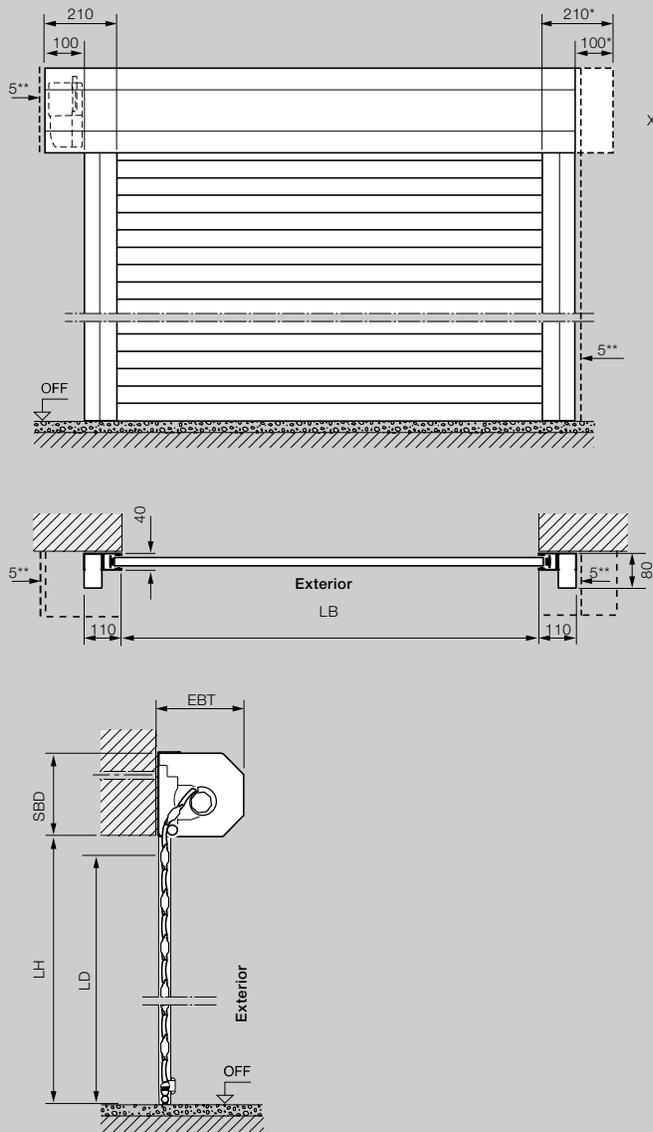


Size range for internal and external roller garage door

Clear height (LH)	3100																				
	3000																				
	2875																				
	2750																				
	2675																				
	2625																				
	2500																				
	2375																				
	2250																				
	2125																				
	2000																				
	1800																				
	1600																				
		1000	1250	1500	1750	1900	2000	2250	2500	2750	3000	3250	3500	3750	4000	4250	4500	4750	5000		
	Clear width (LB)																				

External roller garage door

Fitting in front of the opening, view of fitting side



Dimensions in mm

Explanations

- LB Clear width = ordering size
- LH Clear height = ordering size
- LD Clear passage
- EBT Fitting depth
- SBD Required headroom
- FFL Finished floor level

Fitting depth EBT

- Up to 2300 mm door height 290 mm
- From 2301 mm door height 335 mm

Required headroom SBD

- Up to 2300 mm door height 290 mm
- From 2301 mm door height 335 mm

Clear passage LD

- Height (with operator) LH - 60 mm
- Height (manually operated) LH - 125 mm
- Width LB

- Side space requirement** 110 mm
- External roller garage door operator side 210 mm

Wind load classes

- Up to door widths of 3000 mm Class 4
- Up to door widths of 4500 mm Class 3
- Up to door widths of 5000 mm Class 2

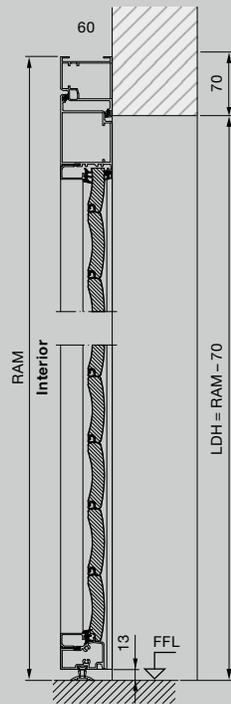
Water tightness under heavy rain Class 2

- X **External roller garage door cladding**
A symmetrical arrangement is also possible, in addition to a variable operator position (as standard on the left, optionally on the right) with projection of the shaft cover on the operator side.
- * For a visually balanced look the barrel casing can be ordered symmetrically!
- ** At least 5 mm distance from fascia panel / side guide

DIMENSIONS AND FITTING DATA, SIDE DOOR

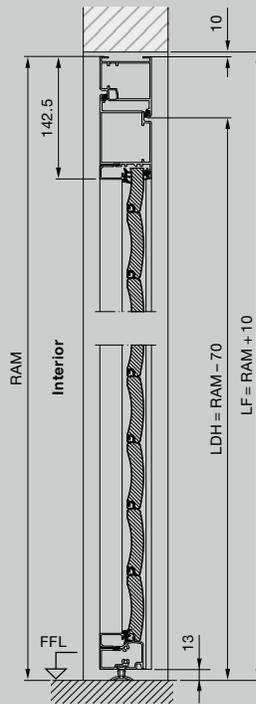
Side door with block frame

Fitting behind the opening, opening inwards



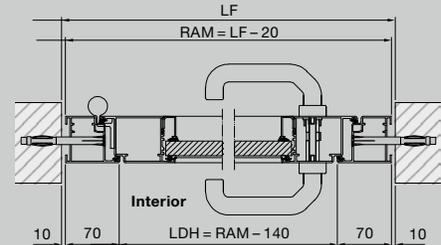
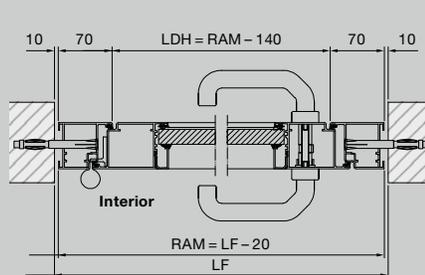
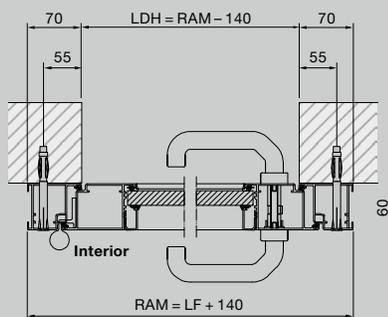
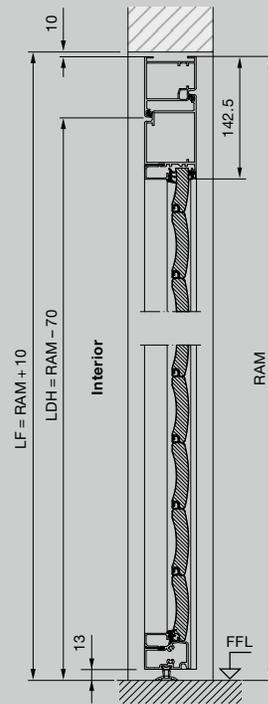
Side door with block frame

Fitting in the opening, opening inwards



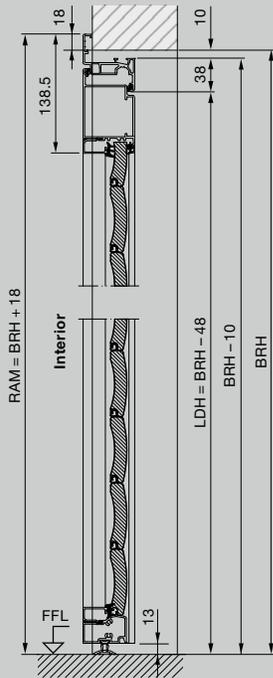
Side door with block frame

Fitting in the opening, opening outwards



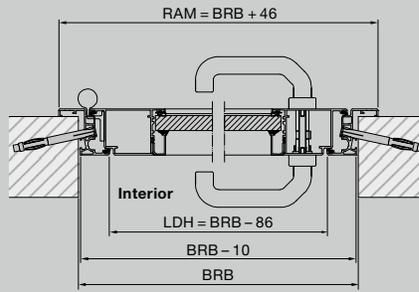
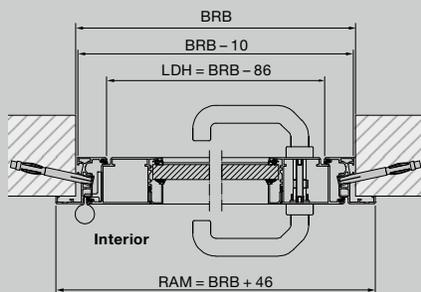
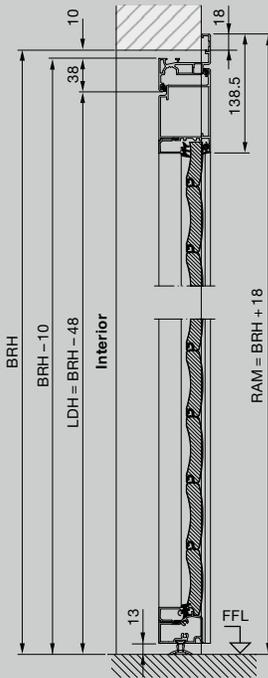
Side door with corner frame

Internal fitting,
opening inwards



Side door with corner frame

External fitting,
opening outwards



Explanations

- RAM Overall frame dimension
- BRB Nominal size - width
- BRH Nominal size - height
- LF Structural opening
- LDB Clear passage width
- LDH Clear passage height

Material

Door frame and frame made of galvanized material, polyester powder-coated primer on both sides, with roller garage door section infill. Position of sections does not match the RollMatic roller garage door. Glazing and ventilation grilles arranged as in the RollMatic roller garage door.

Dimensions in mm