



*Garage Doors With
A Unique Quality*

TECHNICAL GUIDE
APRIL 2008

TECHNICAL & GENERAL INFORMATION

VIENNA

Vienna is a double skinned fully finished and made to measure G.R.P. Sectional Garage door. The panels are made from triple layer resin 450 gram CSM glass mat reinforcement and 'matted in' steel stiffeners. The rear of the door is finished with a white textured GRP panel. Doors over 4420mm (14'6") have additional white powder coat bracings attached to the rear of the panels. Vienna features full weather seals on both sides, at the head and where the door closes to the ground to reduce water and wind borne debris ingress. The interface of each panel has an anti finger-trap CEN compliant safety design (patent pending). Vienna is available in High Gloss White and all standard Wessex Woodgrain colours including the three solid colour options.

VIENNA DC

Vienna DC has all the benefits of Vienna but is supplied with a state-of-the-art electric operator which is matched to the Vienna door. A DC650NIII, with a 650N lifting force, is supplied for doors up to 3048mm (10'0") wide and the more powerful DC800NIII, with 800N lifting force, is supplied for doors over this size. Both operators feature DC motors, soft start-soft stop and anti-back drive security system. This reacts to movement on the boom, if forced entry of a closed door is attempted, and automatically switches from stand-by mode to drive the door closed. A very quiet toothed cable drive one-piece boom is standard with chain drive available as a no cost option. A kevlar belt drive option is available for even smoother, quieter operation. Please note that a two-piece extended boom is recommended for doors over 2134mm (7'0") high.

VIENNA 40

Vienna 40 has double skinned, foam filled, insulated panels for maximum insulation, sound proofing and strength. The rear of the door is finished with a white textured G.R.P. panel. Doors over 4420mm (14'6") have additional white powder coat bracings attached to the rear of the panels. Vienna 40 also has all round weather seals and an anti finger-trap panel interface design (patent pending). Vienna 40 is available in High Gloss White and all standard Wessex Woodgrain colours including the three solid colour options.

VIENNA 40 DC

Vienna 40 DC has all the benefits of Vienna 40 but is supplied with a state-of-the-art electric operator which is matched to the Vienna 40 door. A DC650NIII, with a 650N lifting force, is supplied for doors up to 3048mm (10'0") wide and the more powerful DC800NIII, with 800N lifting force, is supplied for doors over this size. Both operators feature DC motors, soft start-soft stop and anti-back drive security system. This reacts to movement on the boom, if forced entry of a closed door is attempted, and automatically switches from stand-by mode to drive the door closed. A very quiet toothed cable drive one-piece boom is standard with chain drive available as a no cost option. A Kevlar belt drive option is available for even smoother, quieter operation. Please note that a two-piece extended boom is recommended for doors over 2134mm (7'0") high.

GEARING

Vienna lifting gear is a CEN Compliant galvanised steel dual track system with standard low head room gear. Vienna requires only 70mm side and headroom clearance and the top edge of the top panel does not rise above the horizontal track. If the 'Manual locking' option is selected, headroom requirement increases by 60mm and both DC variants require an additional 30mm headroom for the operator boom (50mm on doors over 4420mm / 14'6"). The spring assembly is not wider than the track which means easy installation to flush walls. There is no reduction of drive through width and drive through height is reduced by only 70mm on a manual door and 30mm on an automated door.

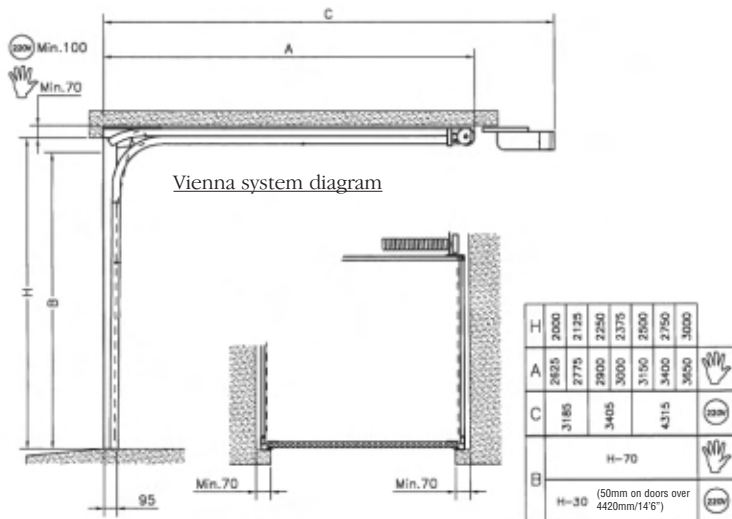

GENERAL INFORMATION

Locking

All Vienna variants are supplied without locking. If ordered as a manually operated door, or locking is required, the 'Manual locking' option must be ordered. The door is prepared for the handle to fit in the first right hand vertical stile, viewed from outside, on the second panel up from the floor.

Window Options

Vienna, Vienna 40 and DC variants are available with black (opaque) windows, which cannot be seen through. Clear and stippled translucent windows are not available.

Matching Woodgrain Vienna Doors

Where doors are to be fitted in close proximity and are required to be coloured as closely as possible, it is vital that they are clearly requested 'To Match' at time of ordering.

Made to Measure Vienna Doors

For a made to measure price take the next door size up e.g. 3810mm (12'6") wide x 2032mm (6'8") high is taken from the 3962mm (13'0") wide x 2134mm (7'0") high price.

Opening Size

All door sizes in this price list refer to internal brickwork / internal frame dimensions. See note "How to order your Door"

How to Order Your Door

Sectional doors are designed to be fitted either on to the back face of a brickwork opening or on to the back face of a timber frame* fitted within the opening. Therefore when ordering your door you must either give us the internal brickwork opening size for doors being fitted directly to the back of the brickwork, or the internal timber frame* size for doors being fitted on to a timber frame*.

*Timber frame must be a minimum of 70mm x 70mm (2³/₄" x 2³/₄").

Top & Bottom Rails & End Stiles

Top, bottom and end stiles (edges) may vary in width or height between doors of the same style depending on size ordered. This is to enable us to cater for your particular size of garage door. If in doubt, please refer to Wessex before ordering.

FINISHING & MAINTENANCE

G.R.P. Doors

Please study the cleaning and maintenance label attached to the back of the door for advice on keeping your door in top class condition.

Door Lubrication

All doors require regular (6 monthly) lubrication of the pivot points and bearings.

TECHNICAL & GENERAL INFORMATION

G.R.P. CROWN RANGE

• 3 Crown G.R.P. Doors

Garage doors in standard and made to measure sizes, with an integral steel frame bonded over to provide added strength and rigidity. Available with canopy or retractable gear.

• 4 Crown G.R.P. Doors

Garage doors in standard and made to measure sizes, Featuring a double skin flat back construction with internal steel reinforcing. Doors over 10' wide feature external white powder coated steel horizontal stiffeners to the rear of the panel for increased rigidity. Available with canopy or retractable gear.

• 5 Crown G.R.P. Doors

Garage doors in standard and made to measure sizes, with an integral steel frame with a flat textured G.R.P. panel bonded to the back of the door. This provides supreme rigidity and an attractive backing to hide the bracing normally visible on all other G.R.P. doors. Available with retractable gear only. Due to the double-wall construction of these doors, no clear or stippled window options are available. NB. 5 Crown doors are only available up to a maximum of 3048mm (10'0") wide and a maximum of 2134mm (7'0") high.

GEARING

• SafeLift (Canopy) Gear

Canopy doors between 1778mm (5'10") and 2134mm (7'0") high and up to 2438mm (8'0") wide are fitted with SafeLift gear featuring high security three point locking and five point retention.

• Maxi-mizer Single Retractable Gear

All retractable doors (excluding 5 Crown) between 1829mm (6'0") and 2286mm (7'6") high and up to 2438mm (8'0") wide and all 5 Crown doors up to 2286mm (7'6") wide and 2134mm (7'0") high are supplied with Maximizer gear. This gear includes unique maximum opening width feature and multi springing. Three point locking is standard on most doors.

• Double and Heavy Retractable Gear

All doors over 2286mm (7'6") high, all 5 Crown doors over 2286mm (7'6") wide and all other doors over 2438mm (8'0") wide are supplied with these gears. All have multi-springing feature.

LOCKING

All Wessex doors are supplied with secure multi-point locking as standard. Optional brass effect lock available (not NorfolkII and SuffolkII which are supplied with 'T' handle lock only).

GENERAL INFORMATION

• Handle Positions

These will vary between canopy and retractable doors of the same size and same style, and between doors of different sizes of the same style with the same gear.

• Handle Holes

These will be drilled as standard. If a handle hole is not required this must be clearly stated at time of ordering.

• Glazed G.R.P. Doors

All window design doors are fitted with standard black (opaque) windows, which cannot be seen through. Clear and stippled translucent windows are available as options on 3 Crown doors only.

• Matching Woodgrain G.R.P. and Timber Doors

Where doors are to be fitted in close proximity and are required to be coloured as closely as possible, it is vital that they are clearly requested 'To Match' at time of ordering.

• Made to Measure Door Prices

Take the next door size up e.g. 3810mm (12'6") wide x 2032mm (6'8") high take the 3962mm (13'0") price. **Note:** Where a price is marked * please refer to the size parameter details below the price for the actual maximum door size available.

• Opening Size

All door sizes stated in this price list refer to internal frame dimensions. Due to the bespoke nature of Wessex garage doors we regret we can not accept order cancellations.

• Top & Bottom Rails & End Stiles

Top, bottom and end stiles (edges) may vary in width or height between doors of the same style depending on size ordered. This is to enable us to cater for your particular size of garage door. If in doubt, please refer to Wessex before ordering.

FINISHING & MAINTENANCE

• G.R.P. Doors

Please study the cleaning and maintenance label attached to the back of the door for advice on keeping your door in top class condition.

• ABS Doors

These doors require no finishing and need only a quick wash down at regular intervals.

• Timber Doors

These need to be treated immediately upon delivery to site with a suitable clear or coloured stain to avoid marking or discolouration and to avoid invalidation of the warranty.

• Steel Doors and Frames

Primed, steel doors and steel frames require a suitable undercoat and topcoat to be applied shortly after delivery in order that the product warranty is not invalidated.

• Door Lubrication

All doors require regular (6 monthly) lubrication of the pivot points and bearings. Full details are contained in the Wessex Service Passport supplied with the door.

IMPERIAL - METRIC CONVERSION TABLE

Imperial	6'6"	7'0"	7'5"	7'6"	8'0"	9'0"	10'0"	11'0"	12'0"	13'0"	14'0"	15'0"	16'0"
Metric (mm)	1981	2134	2261	2286	2438	2743	3048	3353	3658	3962	4267	4572	4877

FRAMES

Steel Frames

Canopy Doors

Suitable for all single doors up to 2438mm x 2134mm (8'0" x 7'0"). Frames are pre-fitted to the door. Standard frame jambs are 54mm (2.18") wide (optional jambs of 68mm (2.23") available on request) and head is 68mm (2.23") high. Minimum door height 1778mm (5'10").

When an Autoglide electric operator is to be specified together with a Wessex Quick Fit Canopy Standard Steel Frame, the frame must be fitted either behind the brickwork or with the rear of the frame flush with the rear of the brickwork.

Single Retractable Doors on Maxi-mizer Door Gear

Suitable for all single doors on Maxi-mizer gear up to 2438mm x 2286mm (8'0" x 7'6") except 5 crown up to 2286mm x 2134mm (7'6" x 7'0"). Frames are pre-fitted to the door. Jambs are 68mm (2.23") wide and head is 68mm (2.23") high. Minimum door height 1829mm (6'0").

Double Retractable Doors on Double or Heavy Door Gear

Suitable for all double doors on double or heavy gear up to 4877mm x 2438mm (16'0" x 8'0"). Frames are supplied separate and NOT pre-fitted to doors. Jambs are 68mm (2.23") wide and head is 68mm (2.23") high. Minimum door height 1854mm (6'1").

Side Hinged Doors

Suitable for all Side Hinged and Personnel Doors. Jambs are 65mm wide and head is 68mm high.

Colours

Plastisol frame colours are;

White BS00E55, Brown (Van dyke brown) BS08B29, Black BS00E53

Woodgrain Golden Oak and Rosewood are polymer laminates and provide a reasonable match to Honey Beech and Dark Mahogany respectively. Please request a sample for confirmation.

G.R.P. Frame Sections

Supplied in three sections, these frames are in two sizes 70mm x 70mm or 95mm x 70mm (2.3/4" x 2.3/4" or 3.3/4" x 2.3/4") for doors up to 4877mm x 2438mm (16'0" wide x 8'0" high). Frames are available in Gloss White or Woodgrain finish in standard colours. Frame sections are not pre-fitted and are supplied loose for fitment to any door.

A colour co-ordinated headbead is supplied with G.R.P. frames. It is not grained and therefore is similar in colour, but not identical, to the grained frame section.

NB. lengths over 4267mm (14'0") will be supplied in 2 sections.

Facias

Finished G.R.P. sections designed to match your G.R.P. door for filling in above or beside the opening. Facias are available in Gloss White or Woodgrain finish in standard colours in widths between 50mm to 305mm (2" to 12"). Minimum length is 1829mm (6'0").

NB. Lengths over 3048mm (10'0") will be supplied in two sections.

Uprights Only (per pair)

Uprights are available in two sizes 70mm x 70mm or 95mm x 70mm (2.3/4" x 2.3/4" or 3.3/4" x 2.3/4") for doors up to 2438mm (8'0") high. Uprights are available in Gloss White or Woodgrain finish in standard colours. Uprights are not pre-fitted and are supplied loose for fitment to any door.

OPERATOR TECHNICAL SPECIFICATION

Feature	Autoglide	DC - 550NIII	DC - 650NIII	DC - 800NIII
Door suitability	SafeLift Canopy gear and CD45 & CD Professional Trackless Canopy gear retro fit	Retractable and sectional	Retractable and sectional	Retractable and sectional
Opening force	400N	550N with electronic 'Soft Start & Stop'	650N electronic "Soft Start and Stop"	800N electronic "Soft Start and Stop"
Normal running load	60W (energy saving circuit) plus 120W light output	200W max (with 230V, 40 Watt light on)	200W max (with 230V, 40 Watt light on)	250W max (with 230V, 40 Watt light on)
"Stand-by" load	7 Watts (energy saving circuit)	<4 Watts (energy saving circuit)	<4 Watts (energy saving circuit)	<4 Watts (energy saving circuit)
Motor	24V DC with thermal overload protection on transformer	24V DC with thermal overload protection on transformer	24V DC with thermal overload protection on transformer	24V DC with thermal overload protection on transformer
Chipset	Smart Entry System auto-calibrating motherboard with LED diagnostics	Smart Entry System auto-calibrating motherboard with LED diagnostics	Smart Entry System auto-calibrating motherboard with Numerical Display diagnostics	Smart Entry System auto-calibrating motherboard with Numerical Display diagnostics
Drive method	Dymetrol belt	Cable & Tooth (Chain or Kevlar Belt Option)	Cable & Tooth (Chain or Kevlar Belt Option)	Cable & Tooth (Chain or Kevlar Belt Option)
Safety door reverse	To fully open position	To fully open position	To fully open position	To fully open position
Light	120W maximum, can be positioned away from the operator (bulb and cabling not included)	Integral 240V fitting with diffuser cover. 40W maximum	Integral 240V fitting with diffuser cover. 40W maximum	Integral 240V fitting with diffuser cover. 40W maximum
Standard boom	1 piece, sits on RHS of door frame	1 piece 'C' channel with 2475mm carriage travel – total operator length 3331mm	1 piece 'C' channel with 2590mm carriage travel – total operator length 3353mm	1 piece 'C' channel with 2590mm carriage travel – total operator length 3353mm
Extended boom (optional) Medium	N/A	N/A	1 piece assembled or 2 piece semi assembled C-channel with 2840mm carriage travel	1 piece assembled or 2 piece semi assembled C-channel with 2840mm carriage travel
Extended boom (optional) Long	N/A	N/A	N/A	1 piece assembled or 2 piece semi assembled C-channel with 3600mm carriage travel
Door size suitability	Up to 2438 x 2134mm (8'0" x 7'0"). Min height 1930mm (6'4")	For Wessex doors up to 4267 x 2134mm (14'0" x 7'0") except 5 Crown doors up to 3048 x 2134mm (10'0" x 7'0")	For Wessex doors up to 4267 x 2286mm (14'0" x 7'6") or 3658 x 2438mm (12'0" x 8'0") except 5 Crown doors up to 3048 x 2134mm (10'0" x 7'0")	For all Wessex retractable and sectional doors including those outside the range of the DC - 550NIII/DC - 650NIII
Headroom required	None	30mm	30mm	30mm
Sideroom required	70mm on RHS of door	None	None	None
Manual disconnect	Yes	Yes	Yes	Yes
Radio receiver	Internal digital, auto-learning rolling code	Digital module. Easy to exchange for other frequencies	Digital module. Easy to exchange for other frequencies	Digital module. Easy to exchange for other frequencies
Radio transmitter	1 x Digital 433 MHz two button mini handset, rolling code (1 billion variations)	2 x digital 868 MHz four button mini handsets, with multibit coding (281 billion variations)	2 digital 868MHz four button mini handsets, with multibit coding (281 billion variations)	2 digital 868MHz four button mini handsets, with multibit coding (281 billion variations)
Transmitter range	10 – 30 metres	10 – 50 metres	10 – 50 metres	10 – 50 metres
Self push button	Yes	No	No	No

SAFELIFT (CANOPY) DOOR GEAR SPECIFICATIONS

STANDARD DOOR AND BRICKWORK APERTURE SIZES

- canopy gear should be fitted either to a weatherbeaded 70mm x 70mm (2.3/4" x 2.3/4") standard timber 'goalpost' frame (not supplied) or a Wessex steel frame (standard frame dimensions = 54mm (2.1/8") wide on side section (optional 68mm (2.2/3") available on request) 68mm (2.2/3") high on top section, 35mm (1.1/3") deep all round).
- The minimum headroom required above the lower face of the frame head is 48mm (1.7/8").

NOTES

- In use the lifting gear reduces drive through heights by 91mm (3.5/8"), although there is no reduction in width.
- For back fixed frames allow the frame to overlap into the aperture by 13mm (1/2") on both sides to allow for coursing and tolerances.

FITTING FRAMES TO THE BRICKWORK

Frames may be fitted within or behind the brickwork as per the drawings shown. Fitting behind the brickwork, if the garage length allows, will increase the drive-through width.

A weatherbead should always be fitted to the under-side of the door frame lintel in front of the door to hide the top gap. This feature is integral on the Wessex steel frame.

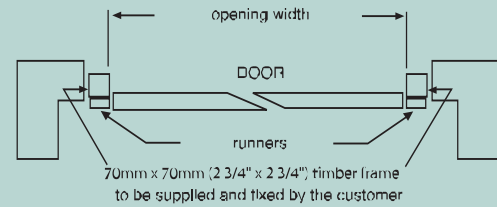

Fitting to timber frame, within the brickwork aperture.

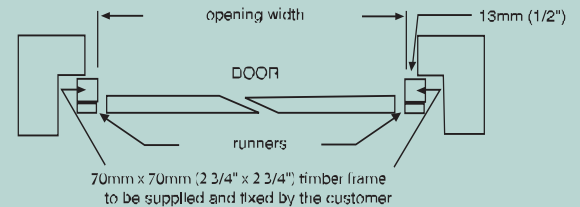

Fitting to timber frame, behind the brickwork aperture.

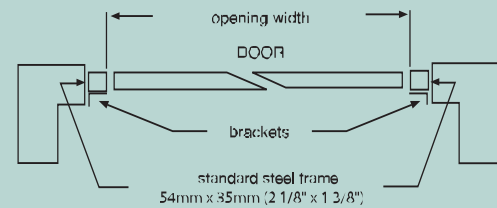

Fitting to Wessex standard steel canopy frame, within the brickwork aperture.

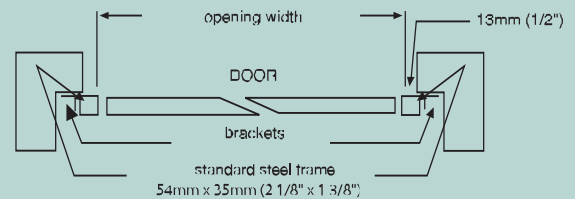

Fitting to Wessex standard steel canopy frame, behind the brickwork aperture.

Opening arcs of travel

Wessex 1981mm (6'6") high SafeLift canopy doors

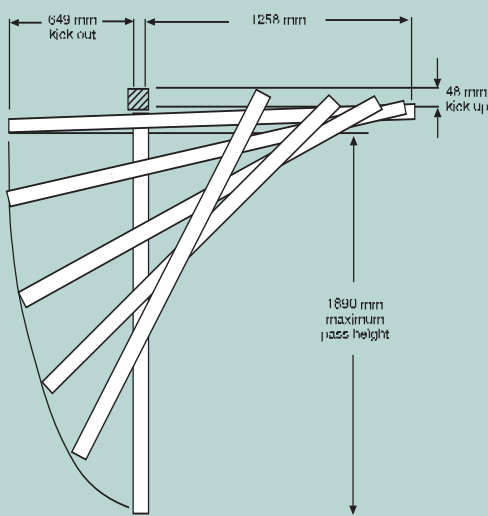

Wessex 2134mm (7'0") high SafeLift canopy doors

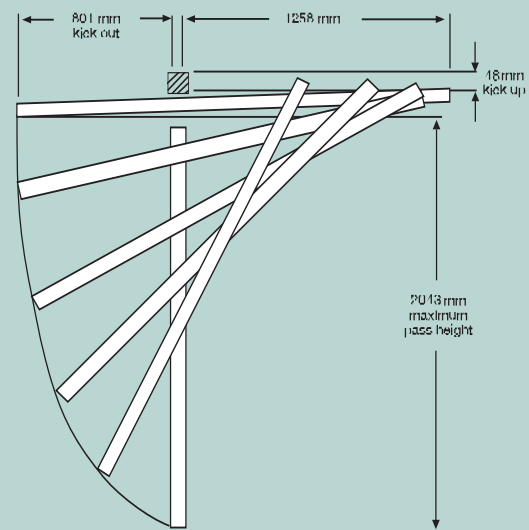

RETRACTABLE DOOR GEAR SPECIFICATIONS

ALL DOORS

Supplied with Maxi-mizer Double or Heavy gear depending on size, see page 2.

Wessex retractable door gear should be fitted to a weatherbeaded 70mm x 70mm (2.3/4" x 2.3/4") standard timber 'goalpost' frame (not supplied). Alternatively Maxi-mizer gear may be fitted to a Wessex quick-fit steel retractable frame (dimensions = 68mm (2.2/3") wide by 60mm (2.1/2") deep all round).

Doors supplied with double or heavy gear can also be supplied with an optional steel frame kit not pre-fitted to the door. Dimensions: 68mm (2.2/3") wide x 75mm (3") deep.

NOTES

In use, lifting gear reduces drive through width by up to 130mm (5.1/4") see page 18. With Maxi-mizer gear there is no reduction in drive-through width up to 1048mm (3'5.1/4") from the ground on 1981mm (6'6") high doors (1200mm (3'11.1/4") on 2134mm (7'0") high doors.

If drive-through clearances are critical, please ask for full details.

FITTING FRAMES TO THE BRICKWORK

Frames may be fitted within or behind the brickwork as per the drawings shown. Fitting behind the brickwork, if the garage length allows, will increase drive-through width by up to 114mm (4.1/2").

A 20mm x 20mm (4/5" x 4/5") weatherbead should be fitted to the underside of the door frame lintel in front of the door. This feature is integral on the Wessex steel frame.

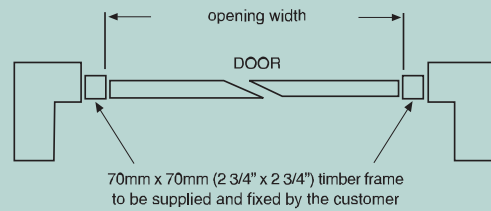

Fitting to timber frame, within the brickwork aperture.

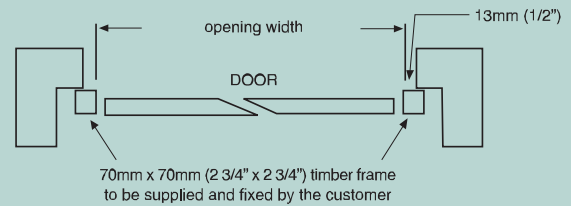

Fitting to timber frame, behind the brickwork aperture.

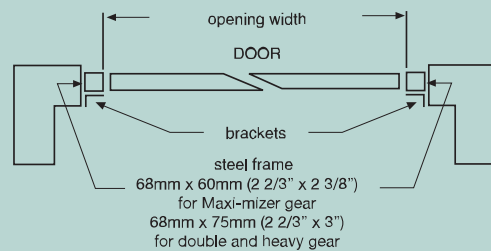

Fitting to Wessex steel retractable frame, within the brickwork aperture.

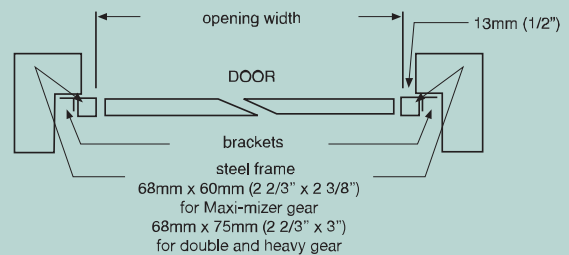

Fitting to Wessex steel retractable frame, behind the brickwork aperture.

SPECIFICATIONS

Opening arcs of travel

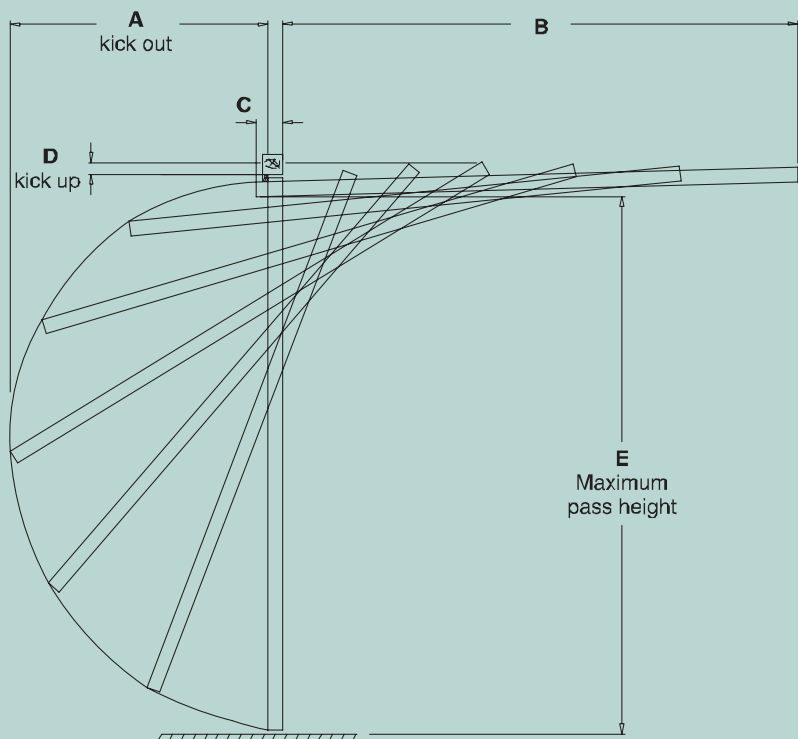

Size Code	1981mm (6'6") high Maxi-mizer retractable doors	2134mm (7'0") high Maxi-mizer retractable doors
A	880mm	1030mm
B	1877mm	1877mm
C*	116mm	268mm
D	38.5mm	38.5mm
E**	1884mm	2030mm

Size Code	1981mm (6'6") high double retractable doors	2134mm (7'0") high double retractable doors
A	900mm	1040mm
B	1877mm	1877mm
C*	131mm	283mm
D	43mm	43mm
E**	1890mm	2040mm

*C

The amount that the door protrudes out from the back face of the frame with the door in the open position

**E

Note: For doors over 2134mm (7'0") tall - if drive through is critical please check dimension prior to ordering

MAXI-MIZER DRIVE-THROUGH CLEARANCES

Single sized retractable doors up to 2438mm (8'0") wide.

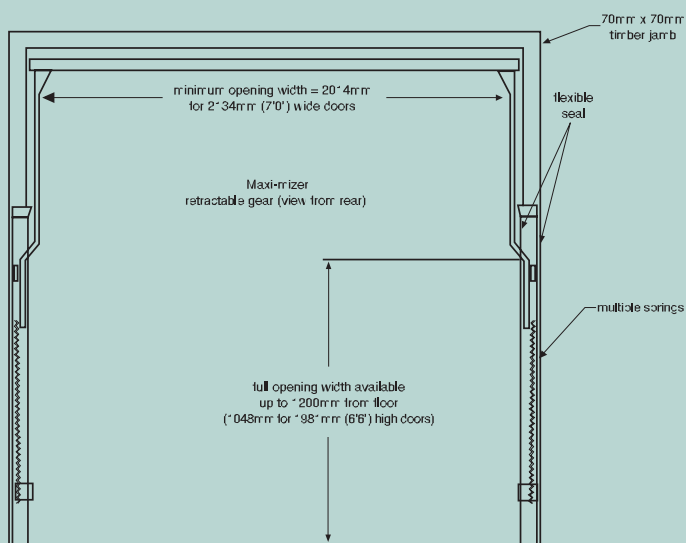

DOUBLE OR HEAVY DRIVE-THROUGH CLEARANCES

Double sized retractable doors over 2438mm (8'0") wide.

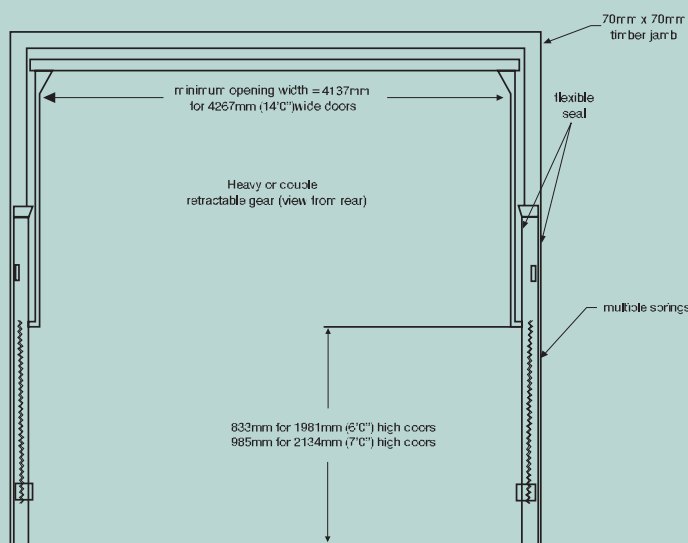

ALL OTHER DOOR SPECIFICATIONS For further information, please ask for details.

CI/SfB			
127	(31.56)	X	

PRODUCT WARRANTY – WESSEX GARAGE DOORS LTD. (WESSEX)

PRODUCT GUARANTEES

Subject to conditions set out below;

- Wessex garage doors are guaranteed against any form of manufacturing defect for a period of 2 years from the date of original purchase.
- Wessex Garage Doors Limited also guarantee that its garage doors will operate safely and reliably for a period of 10 years from original installation.
- Wessex electric operators are guaranteed against any form of manufacturing defect for a period of 5 years for mechanical elements, motors and transformers and for a period of 2 years for other electronic and radio equipment.
- The Exterior finish is guaranteed to provide an effective weatherproof membrane which will resist perforation of the substrate from the weather side due to corrosion for the periods indicated below.

10 years - GRP, ABS Elite

2 years - Primed Steel, Basecoat Timber Doors

- Colour change or fade to the exterior surface will be limited and uniform for a period of 2 years.

CONDITIONS

- During the comprehensive 2 year guarantee period Wessex Garage Doors Limited undertake to repair or replace (at its discretion), and without charge, products or components which have suffered any form of manufacturing defect. Claims must be notified within 3 days from the date of delivery or within a reasonable time after discovery of any defect.
- Products covered by these guarantees must have been purchased through an authorised Wessex garage door distributor or as original equipment attached to a newly built dwelling.
- The warranties shall apply for normal use only. Normal use constitutes no more than 5 operations (open/close cycles) per day.
- The warranties offered attach to the Wessex product only and no consequential damages will apply no matter how caused.
- No liability will be accepted as a result of normal wear and tear, incorrect storage, incorrect handling, faulty installation, incorrect use or wilful damage.
- Claims under this guarantee must be made through the original supplier and accompanied by relevant documentation indicating the date of purchase (e.g. receipt).
- Wessex Garage Doors Limited maximum liability shall be the original purchase price inclusive of Value Added Tax at the rate prevailing when supplied.
- Any product which is the subject of a claim:
 - must have been correctly installed in accordance with the installation instructions supplied and thereafter properly maintained by a suitably experienced engineer on a regular basis as set out in the Maintenance and Operating Instructions provided with every door. (Additional copies of these instructions are available by calling 01202 825451). We recommend that regular maintenance is provided by a suitably experienced engineer. See your Yellow Pages for your local Wessex Garage Door or AGDS specialist.
 - must have the manufacturers reference number still intact (found on the barcode label on the door)
 - must not have been modified in any way.
- Claims will not be accepted where the cause is due to:
 - impact or mechanical damage suffered during or following installation, e.g scratches, indentations, tears, scuffs or other surface abrasion.
 - damage or discolouration caused by contact with any form of caustic, abrasive or corrosive substance, fumes, bird droppings, fire, smoke, floodwater, salts, acids, or from exposure to abnormal atmospheric pollution.
- This guarantee excludes normal wear and tear on items such as cones, cables, spindles, lock cylinders, hinges or springs.
- Only Wessex original spare parts must be used when required. The use of non-Wessex parts shall invalidate this guarantee. Warranty period for replacement parts is 6 months or the balance of the original warranty period if greater.

- The Exterior Finish Guarantee applies only to the weatherside surface and where more than 5% of the surface area of the door is affected. Surfaces must be freely exposed to washing by rainfall and kept clear of accumulated dirt and debris and given equal exposure to local environmental conditions and consistent natural lighting conditions across the face of the door. Special attention is drawn to Clause (9) (i).
- Primed steel doors and basecoat treated timber doors must receive a suitable exterior quality finishing topcoat immediately after installation. This topcoat finish must be applied strictly in accordance with the manufacturer's instructions.
- The guarantee period for electric operators excludes batteries, fuses and light bulbs.
- Parts replaced free of charge become the property of Wessex Garage Doors Limited.
- Attempted repairs by non-qualified individuals shall invalidate this guarantee.
- The specific terms of this guarantee shall only apply to products purchased on or after April 2008 within the UK and Eire.
- Wessex garage doors and associated products are sold subject to the Wessex Garage Doors Limited Standard Terms and Conditions of Sale, copies of which are available upon request. Wessex Garage Doors Limited shall not be liable as a result of any representation, implied warranty or other term or condition or for any consequential loss or damage, costs, expenses or other claims whatsoever except as expressly set out in these Terms and Conditions of Sale.

General Advice

Door Cleaning

Periodically clean the door panel using warm water and a soft cloth or sponge. Allow to dry naturally. Never use detergent, abrasive, caustic or solvent based cleaners as they may damage the door surface. Bird droppings should be removed immediately as these can be particularly caustic.

Customer Maintenance

Moving parts should be lubricated regularly to ensure smooth operation. Every six months visually inspect all wear items (including cables) for signs of wear. If wear is detected we recommend you contact your local Wessex approved service engineer to arrange for a replacement. Garage door springs are under extreme tension and should only be repaired or replaced by a suitably qualified engineer.

Other performance issues affecting Wessex garage doors are:

Wessex G.R.P. doors are individually handcrafted products manufactured to specific customer order. Due to the nature of the product and the hand finishing processes used they may occasionally display small blemishes which do not detract from the overall appearance of the product. These are regarded as being within manufacturers tolerance when such blemishes are not visible to the naked eye when viewed from a distance of three metres. Similarly, Woodgrain effect products will, like the natural material, display colour variations across their surface and colour will vary from door to door. Ordering doors to match helps reduce the variation but will not eradicate it entirely.

Translucency of the door panel may vary when viewed from the inside on a bright day due to variations in laminate thickness. This does not represent a manufacturing defect and overall performance is not affected.

Size and Deflection - the natural curing process does not affect the ultimate product size and a tolerance of ± 6 mm on both height and width is deemed acceptable. Up and over doors in the 'open' position will display a level of vertical deflection or 'sag' across the width of the panel and up to 6mm per linear metre is within design tolerance.

Wessex Timber doors are made from the finest timber obtained from managed and sustainable sources. Prior to fitting they must not be stored in direct sunlight or exposed to splashes or rain as colour fading and/or staining may result. The Wessex product guarantee does not cover natural variations in colour, warping, swelling or shrinkage due to the ordinary natural processes of ageing, fading or the effects of weather or climate nor does it cover the incidence of similar degradation which could have been prevented by carrying out finishing and maintenance procedures as recommended by Wessex.

Wessex Steel doors are manufactured using high quality galvanised steel with a white powder coated primed finish as standard (except oversize doors). A suitable exterior grade of paint should be applied as a finishing coat in accordance with the paint manufacturers instructions.

These terms and conditions do not affect your statutory rights.